

AMMORTIZZATORI SHOCK ABSORBERS



CATALOGUE EDITION
2022/23

Ammortizzatori idraulici (oil)

Hydraulic shock absorbers
Amortisseurs hydrauliques
Hydraulische Stossdämpfer
Amortiguadores hidraulicos

Ammortizzatori a gas

Gas charged shock absorbers
Amortisseurs à gaz
Gasdruck Stossdämpfer
Amortiguadores de gas

① **Ammortizzatore tubolare**

- ⓐ Telescopic shock absorber
- ⓑ Amortisseur conventionnel
- ⓒ Konventionelle Stossdämpfer
- ⓓ Amortiguador telescópico



① **Ammortizzatore con sede molla**

- ⓐ shock absorber with spring seat
- ⓑ Amortisseur à siège de ressort
- ⓒ Stossdämpfer mit Federsitzteller
- ⓓ Amortiguador con asiento para muelle



① **Cartuccia MacPherson**

- ⓐ MacPherson insert
- ⓑ Jambe de force type MacPherson
- ⓒ Komplettes MacPherson Federbein
- ⓓ Cartucho MacPherson



① **Montante MacPherson**

- ⓐ Complete MacPherson strut
- ⓑ Cartouche type MacPherson
- ⓒ MacPherson Federbeineinsatz
- ⓓ Columna MacPherson



① **Tubolare rinforzato**

- ⓐ Extra heavy duty shock absorber
- ⓑ Amortisseur super renforcé
- ⓒ Extra verstärkte Stossdämpfer
- ⓓ Amortiguador telescópico reforzado





BUMPER

tampone di fine corsa

SHOCK ABSORBER

ammortizzatore

PROTECTION KIT

tubo protezione stelo

COIL SPRING

molla elicoidale

TOP STRUT MOUNT

supporto ammortizzatore





IL POTERE DELLA GAMMA

**UN'AZIENDA CHE CRESCE E SI TRASFORMA
NEL TEMPO PER DIVENTARE UN VERO
SPECIALISTA NEL SETTORE SOSPENSIONI**

Siamo un'azienda italiana con una grande storia nel mercato Aftermarket, il fondatore Alfeo Moret, la creò negli anni del boom della motorizzazione italiana, gli anni della "Fiat Cinquecento", dell'Alfa, delle Lancia e dei camion OM.

Oggi 2022, realizziamo 49 anni di attività, agli inizi erano anni in cui bisognava essere bravi a "ricostruire" gli ammortizzatori. A furia di smontare e ricostruire abbiamo messo le basi concrete per imparare a produrli.

L'esperienza si è trasformata progressivamente in una vastissima gamma di modelli, capace oggi di realizzare e gestire a magazzino oltre 4500 codici diversi di ammortizzatori per auto, in pronta consegna, capaci di soddisfare l'esigenza di allestimento di quasi 2.000 modelli di auto.



D.S.R.A.V.

IS VITAL!

Una **GAMMA COMPLETA**

Con "VITAL suspensions" portiamo a coronamento tutto il lavoro svolto negli ultimi 49 anni dal fondatore; dopo 49 anni di intenso miglioramento produttivo, siamo in grado di offrire, agli operatori professionali, una gamma molto articolata e soprattutto reale, pronta per arrivare a destinazione.

Il grande e moderno magazzino di Vittorio Veneto (TV) in prossimità dell'A27, in un'area dotata anche di porto doganale ci consente velocità di consegna in tutta Europa e nel mondo, dove siamo presenti con una rete capillare di validi partner distributivi.

Da considerare che la nostra produzione oltre agli ammortizzatori singoli, propone al mercato la variante a Set, che consiste nei 4 ammortizzatori per auto in un'unica scatola. Tale variante viene fornita completa di accessori come tamponi, soffietti e supporti gomma e metallo per ottenere l'equipaggiamento completo per affrontare qualsiasi condizione di sostituzione parziale o integrale.

A complete **WIDE RANGE**

With "VITAL suspensions" we have added the crowning glory to all the 49 years of effort since the day we were founded; after 49 years of intense production enhancements, we are in a position to offer automotive professionals an extremely comprehensive and above all genuine range that is ready to be transported to wherever it needs to be.

Our huge and modern warehouse in Vittorio Veneto (TV), close to the A27 motorway and in an area that also has a customs port, enables us to send items quickly throughout Europe and the world, where we have a wide network of highly competent distribution partners.

Our offering doesn't just end with single shock absorbers either, it also includes the Set variant, which consists of 4 car shock absorbers in a single box. This variant comes with a complete set of accessories such as bumpers, bellows and rubber and metal mounts to deal with any possible shock absorber replacement requirement, be it partial or complete.

An **UNBEATABLE RANGE**

We are an Italian company with many years' experience in the automotive aftermarket.

Its founder Alfeo Moret, created the company during the boom years of the Italian motor industry, those that saw the "Fiat Cinquecento", the Alfa, the Lancia and OM trucks.

Today, in 2022, we are marking 49 years in the industry, the early part of which was when it was necessary to be able to "rebuild" shock absorbers. Through consistently disassembling and rebuilding them we laid the concrete foundations for learning how to make them.

This experience has been steadily transformed into a vast array of models, resulting in a warehouse holding over 4500 different codes of car shock absorbers, ready for immediate delivery and able to satisfy the set-up requirements of almost 2,000 models of car.



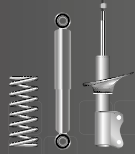

1973

Nasce **O.S.R.A.V. Alfeo Moret S.p.A.** come rigeneratore di ammortizzatori per autoveicoli e molle di sovraccarico

1988

Leader Italiano nella rigenerazione di ammortizzatori ed inizio della produzione di ammortizzatori NUOVI

Ammortizzatori rigenerati e molle venduti con i nuovi marchi **TOPLINE** e **GLOBO**

1995

Nuovo Brand **Wktory** e consolidamento della produzione di ammortizzatori nuovi

New Brand **WKTORY** and consolidation of the production of **NEW SHOCK ABSORBERS**

Shock Absorbers Manufacturing Company

O.s.r.a.v. Alfeo Moret S.p.a. starts its own business with rebuilding shock absorbers and producing auxiliary coil springs

Over the years **O.s.r.a.v.** becomes the leader rebuilding shock absorbers and started the production of **NEW shock absorbers**

Rebuilt shock absorbers and auxiliary coil springs were sold with our dedicated brands **TOPLINE** and **GLOBO**

2022

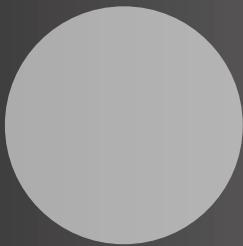

SUSPEA

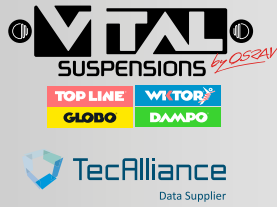

2000

Nuovo Brand **DAMPO** per lo sviluppo di esclusive in tutto il territorio nazionale ed internazionale

New Brand **DAMPO** created for the development of the exclusive franchise for the domestic and abroad market

2008

I marchi **GLOBO** e **TOPLINE** si convertono in marchi per la vendita di Ammortizzatori **NUOVI**

GLOBO and **TOPLINE**, originally dedicated for the rebuilt shock absorbers were converted for the production of completely **NEW** shock absorbers.

2017

O.S.R.A.V. introduce il nuovo brand **VITAL SUSPENSIONS**. Restyling dell'immagine aziendale e nuove strategie di comunicazione. O.S.R.A.V. singla l'accordo con Tecdoc come fornitore di dati con il marchio **VITAL SUSPENSIONS**.

O.S.R.A.V. presents its New brand **VITAL SUSPENSIONS** which represents the new look of the company and the beginning of new communication strategies. O.S.R.A.V. signs the agreement with Tecdoc as a data provider with the **VITAL SUSPENSIONS** brand.

2020

Con il marchio **VITAL SUSPENSIONS** si realizza l'inizio della nuova sfida zione di Ammortizzatori Elettronici e Sospensioni ad Aria

VITAL SUSPENSIONS is the beginning of the new challenge which starts with the production and regeneration of Electronic shock absorbers and Air Suspensions.





**VIAGGIARE
IN SICUREZZA!
SAFETY TRAVELLING !**



SICUREZZA, COMFORT E QUALITÀ!

Questa linea di nuovi ammortizzatori con garanzia biennale certificata, vince in sicurezza, comfort e qualità.

Disponibili in una gamma completa, con versioni olio e olio-gas, gli ammortizzatori VITAL SUSPENSIONS sono riusciti ad anticipare le nuove tecnologie di fabbricazione, presentandosi come la migliore sistemi produttiva per l'aftermarket più sensibile e attento alle novità.

Osrav valorizza ed investe nel proprio reparto di Ricerca & Sviluppo per assicurare un progresso costante, senza porre limiti alla capacità di scoperta e invenzione.

SAFETY, COMFORT AND QUALITY!

This certified range of new shock absorbers with their two-year guarantee is a winner in terms of safety, comfort and quality. In a complete range of oil and gas-oil versions VITAL SUSPENSIONS shock absorbers have managed to anticipate new manufacturing technologies by presenting the best combined solutions for the after market which is the most sensitive towards innovations.

Osrav invest heavily in its Research and Development division, to ensure constant progress without placing restrictions on the ability to discover and invent.

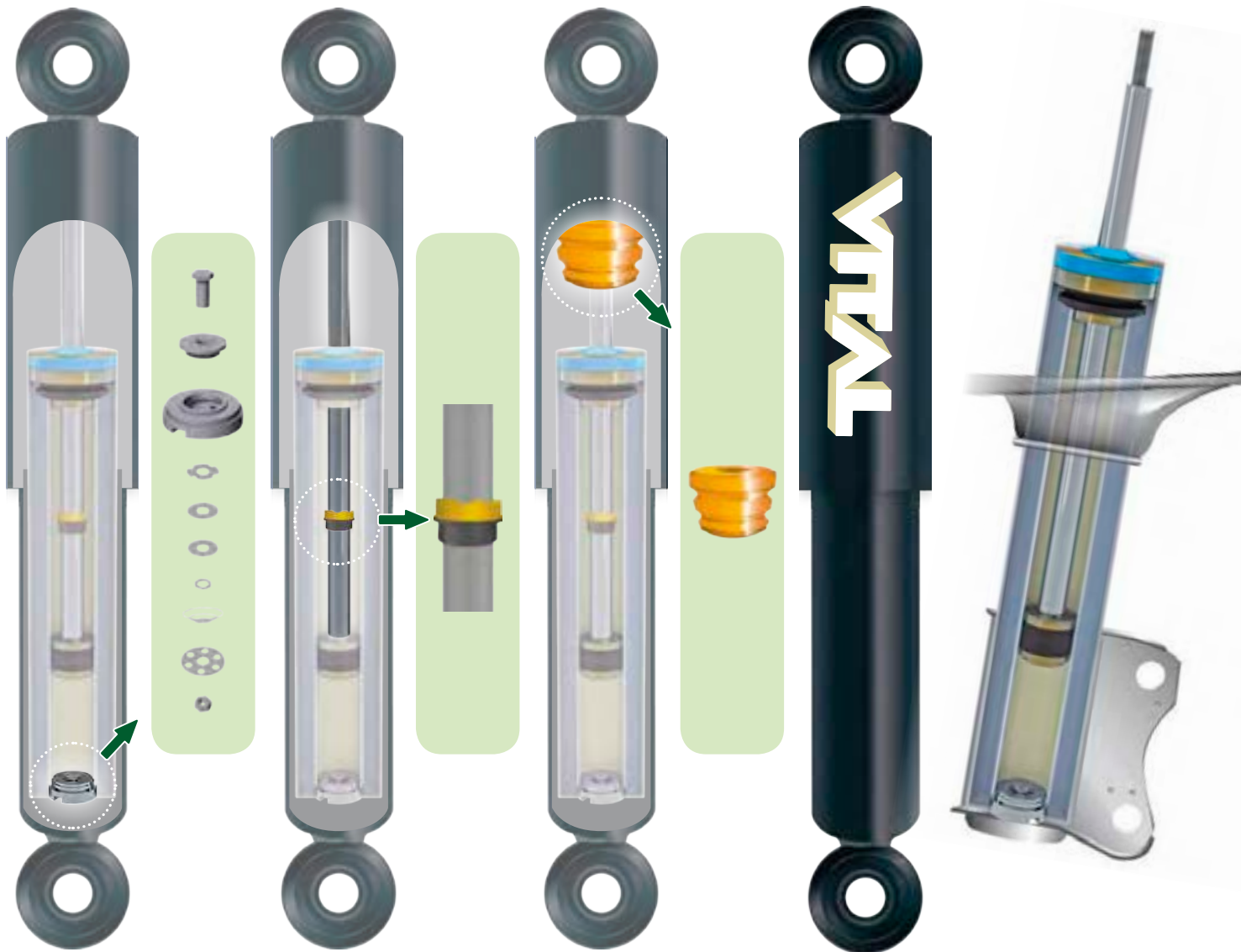



UNA GAMMA COMPLETA

www.VITALSUSPENSIONS.it

ITALIAN QUALITY

AIR & ELECTRONIC SUSPENSIONS

L'INNOVAZIONE
INNOVATION

MINICARS

MINICAR DI
PRESTIGIO
PRESTIGE MINICARS

TRADIZIONE
DI SICUREZZA
TRADITION IN SAFETY

SHOCK ABSORBERS

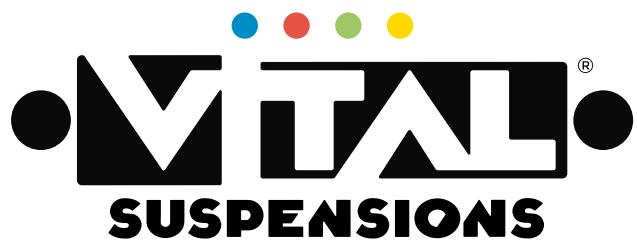

COMPLETEZZA
DI GAMMA
FULL RANGE

STRUT TOP MOUNTS

www.VITALSUSPENSIONS.it

ITALIAN QUALITY

CLASSIC CARS
KEEP THEM ALIVE!

 **TecAlliance**
Data Supplier

 **inforicambi**
Partner Ufficiale

MOLLE DI CARICO
PRESTANTI
HIGH-PERFORMANCE LOAD SPRINGS

 **ClipParts**
CATALOGO ELETTRONICO

Kromeda
a Solera company

MOLLE A GAS
RESILIENTI
RESILIENT GAS SPRINGS



VITAL[®]
SUSPENSIONS

Panda 1^a serie 4x4

REAR
POSTERIORE



ANTERIORE
FRONT



**AMMORTIZZATORI
RIALZATI**





SOSPENSIONI RINFORZATE
DUCATO / DUCATO CAMPER
CITROËN JUMPER - PEUGEOT BOXER



CONSULTAZIONE CATALOGO

pag. 13

How to look up in the catalogue - Consultation du catalogue - Nachschlage des Katalog - Consulta de catálogo - Consulta de Catálogo

Consultatie van de catalogus - Sådan slår du op i kataloget - Руководство пользователя

ALFA ROMEO	pag. 14	JAGUAR	pag. 85	SKODA	pag. 169
AUDI	pag. 18	JEEP	pag. 86	SMART	pag. 172
AUSTIN	pag. 25	KIA	pag. 88	SSANG YONG	pag. 173
AUTOBIANCHI	pag. 26	LADA	pag. 91	SUBARU	pag. 174
BEDFORD	pag. 27	LANCIA	pag. 92	SUZUKI	pag. 176
BMW	pag. 28	LAND ROVER	pag. 95	TALBOT	pag. 180
CHEVROLET	pag. 37	LEXUS	pag. 97	TOYOTA	pag. 181
CHRYSLER	pag. 38	MAZDA	pag. 98	VAUXHALL	pag. 191
CITROËN	pag. 39	MERCEDES	pag. 102	VOLKSWAGEN	pag. 197
DACIA	pag. 46	MINI	pag. 110	VOLVO	pag. 209
DAEWOO - CHEVROLET	pag. 47	MITSUBISHI	pag. 111	ZASTAVA	pag. 213
DAIHATSU	pag. 49	NISSAN	pag. 116		
DR	pag. 50	OPEL	pag. 126		
FIAT	pag. 51	PEUGEOT	pag. 135		
FORD	pag. 62	PIAGGIO	pag. 144		
HONDA	pag. 73	POLSKI	pag. 144		
HYUNDAI	pag. 78	PORSCHE	pag. 145		
INFINITI	pag. 82	RENAULT	pag. 146		
INNOCENTI	pag. 82	ROVER	pag. 159		
ISUZU	pag. 83	SAAB	pag. 161		
IVECO	pag. 84	SEAT	pag. 163		

INFORMAZIONI E DISEGNI TECNICI

pag. 214

technical information and drawings - informations techniques et dessins - technische Informationen und Zeichnungen - información técnica y dibujos - informações técnicas e desenhos - technische informatie en tekeningen - tekniske oplysninger og tegninger - техническая информация и чертежи

CONDIZIONI GENERALI DI VENDITA

pag. 223

General sales term and conditions - Conditions générales de ventes - Allgemeine Verkaufsbedingungen - Condiciones generales de las ventas

Condições Gerais de Venda - Algemene verkoopcondities - Generale salgs konditioner - Основные условия продажи

PRINCIPALI CAUSE DI DANNEGGIAMENTO NON IMPUTABILI A DIFETTOSITÀ DEL PRODOTTO

pag. 225

Principle defects due to improper handling of product

ATTACCHI AMMORTIZZATORI

pag. 227

Shock absorbers end fitting - Type des fixations des amortisseurs - Befestigung der Stossdämpfer - Esquema de anclajes

Diagrama de Montagem de Amortecedores - Bevestigingstype van de schokdemper - Monterings vejledning - Крепления амортизаторов

LEGENDA

pag. 228

Legend - Legende - Bemerkung - Leyenda - Legenda - Legende - Bemærkning - Легенда

NUOVA CONSULTAZIONE CATALOGO

NEW CATALOGUE CONSULTATION - NOUVELLE CONSULTATION SUR LE CATALOGUE -
NEUE KATALOGKONSULTATION - NUEVA CONSULTA DE CATÁLOGO -
NOVA CONSULTA DE CATÁLOGO - NIEUWE CONSULTATIE OVER DE CATALOGUS -
NY CATALOG CONSULTATION - НОВАЯ КОНСУЛЬТАЦИЯ КАТАЛОГА

Coppia ammortizzatori
Double shock absorbers -
Doubles amortisseurs -
Doppelstoßdämpfer
Amortiguadores en pareja
Amortecedores duplos
Dubbele Schokdempers
Dobbel Støtdæmpere
двойные амортизаторы

Ammortizzatore singolo sinistro
Single left shock absorber
Simple amortisseur gauche
Einzelner Linker Stoßdämpfer
Amortiguador individual izquierdo
Amortecedor esquerdo unico
Enkele Links Schokdemper
Enkelt Venstre Støddæmper
одиночный левый амортизатор

Ammortizzatore singolo destro
Single right shock absorber
Simple amortisseur droit
Einzelner Rechter Stoßdämpfer
Amortiguador individual derecho
Amortecedor direito unico
Enkele Rechts schokdemper
Enkelt Højre Støddæmper
односторонний амортизатор

Supporti gomma & metallo
Strut mount
Semmelle de suspension
Federbeinstützlager
Topes de suspensión
Apoio do amortecedor
Veerpootlager
Stottelager fjaerbein
Крепление стойки амортизатора

Kit di protezione
Protection kit
Kit de protection
Protektion Kit
Kit de protecció
Jogo de protecção
Beschermins Kit
Beskyttelsessæt
защитный набор



► BMW (D)

3 SERIES (E46) 4X2

316i, 318i, 320i excl.: M-Sport Pack II	(E46)	02.98 - 09.01		1a		GAS	210185	110185.1	110185.2	600240	516004
				2b			GAS	211318	111318.0	600320	516001

Data

Date - Date
Baujahr - Fecha
Data - Bouwjaar
Productions år - Дата

Marca/Costruttore

Manufacturer - Fabricant
Hersteller - Marca/Costrutor
Fabricante - Merk
Fabrikant - Производитель

Specifica Modello

Model specifications - Caractéristiques modèles
Besonderheit - Especificación modelo
Especificação modelo - Model-Specificaties
Model Betegnelse - Объем двигателя

Modello Veicolo

Model - Modèle
Modell - Modelo
Modelo - Model
Model - Модель

Asse Posteriore

Rear wheels - Roues Arrière
Hinterachse - Tren Trasero
Trasería - Achter - Bag Aksel
задняя ось

Tipo di applicazione

Application type - Type de application
Anwendung der Stossdämpfer - Esquema de anclajes
Esquema de Montagem - Bevestiging van de schokdemper
Anvendelse - Вид применения

Note

Note - Notes
Anmerkungen - Anotación
Nota - Opmerkingen
Bemærkning - примечания

Asse Anteriore

Front wheels - Roues Avant
Vorderachse - Tren Delantero
Dianteria - Voor - For Aksel
передняя ось

ALFA ROMEO (I)

ALFA 6

2.0, 2.5 Turbo Diesel	(119)	04.79 - 12.86			±	OIL	201231	101231.0			
						GAS	211237	111237.0			

ALFA 33

1.2, 1.3, 1.3 S, 1.5, 1.7 excl. 4X4 1.8 TD excl. 4X4	(905, 905A)	06.83 - 02.87		1A	±	GAS	210101	110101.1	110101.2			516004
						GAS	211233	111233.0				
1.5 4X4	(905, 905A)	06.83 - 02.87			±	GAS	210108	110108.1	110108.2			516004
						GAS	211233	111233.0				
1.2, 1.3, 1.5, 1.7, 1.8 TD	(905, 905A)	03.87 - 01.90		1A	±	GAS	210101	110101.1	110101.2			516004
						GAS	211233	111233.0				
1.3, 1.3 S, 1.4, 1.5, 1.7 excl. 1.7ie 16V, 4X4	(907A, 907B)	01.90 - 01.93		1B	±	GAS	210102	110102.1	110102.2			516004
						GAS	211233	111233.0				
1.7ie 16V 4X2 1.7ie 16V SW 4X2	(907A) (907B)	04.90 - 01.93										
1.7ie 16V 4X4 1.7ie 16V SW 4X4	(907A) (907B)	04.90 - 01.93			±	GAS	211233	111233.0				
1.8 TD	(907A, 907B)	04.90 - 01.93			±	GAS	211233	111233.0				
1.3, 1.4, 1.5, 1.7 excl. 1.7ie 16V	(907A, 907B)	02.93 - 09.94			±	GAS	210114	110114.1	110114.2			516004
						GAS	211233	111233.0				
1.7ie 16V	(907A, 907B)	02.93 - 09.94			±	GAS	210114	110114.1	110114.2			516004
						GAS	211233	111233.0				

ALFA 75

	(162B)	06.85 - 02.92			±	GAS	211234	111234.0			
						GAS	211235	111235.0			

ALFA 90

	(162)	09.84 - 07.87			±	GAS	211234	111234.0			
						GAS	211235	111235.0			











ALFA 145

1.3, 1.6, 1.7 16V Boxer	(930)	03.95 - 12.96			±	GAS	210109	110109.1	110109.2			516004
						GAS	211391	111391.0				-
1.4 16V T.S., 1.6 16V T.S. 1.8 16V T.S., 2.0 16V T.S.	(930)	12.96 - 01.01			±	GAS	210103	110103.0				516004
						GAS	211391	111391.0				-
1.9 TDS	(930)	07.94 - 01.01			±	GAS	210103	110103.0				516004
						GAS	211391	111391.0				-
1.9 JTD	(930)	02.99 - 01.01			±	GAS	210107	110107.0				516004
						GAS	211391	111391.0				-











ALFA 146

1.3, 1.6, 1.7 16V Boxer	(930) (930)	03.95 - 12.96			±	GAS	210109	110109.1	110109.2			516004
						GAS	211391	111391.0				-
1.4 16V T.S., 1.6 16V T.S. 1.8 16V T.S., 2.0 16V T.S.	(930) (930)	12.96 - 01.01			±	GAS	210103	110103.0				516004
						GAS	211391	111391.0				-

























ALFA ROMEO (I)

 1.9 TDS	(930)	07.94 - 01.01				GAS	210103	110103.0			516004
						GAS	211391	111391.0			-
 1.9 JTD	(930)	02.99 - 01.01				GAS	210107	110107.0			516004
						GAS	211391	111391.0			-



















ALFA 147

 excl. 3.2 GTA	(937)	01.01 - 03.10				GAS	210978	110978.0	600590	516010
						GAS	210116	110116.0	600600	516004
 3.2 GTA	(937)	02.03 - 03.10				GAS	210988	110988.0	600590	516010
						GAS	210122	110122.0	600600	516004















ALFA 155

 1.6, 1.7, 1.9 TD, 2.0 TD excl. †	(167)	01.92 - 12.97				GAS	210103	110103.0		516004
						GAS	211404	111404.0		-
 1.8 TS, 2.0 TS, excl. †	(167)	01.92 - 12.97				GAS	210103	110103.0		516004
						GAS	211404	111404.0		-
 2.5 V6 excl. †	(167)	01.92 - 12.97				GAS	210107	110107.0		516004
						GAS	211404	111404.0		-
 2.5 TD excl. †	(167)	04.93 - 12.97				GAS	210107	110107.0		516004
						GAS	211404	111404.0		-
 2.0 Turbo 4x4 excl. †	(167)	01.92 - 12.97				GAS	210107	110107.0		516004
										











ALFA 156

 excl. † > Ch. 0116245	(932)	09.97 - 10.98				GAS	210975	110975.0	600590	516010
						GAS	210113	110113.0	600600	516004
 excl. † Ch. 0116246 >	(932)	10.98 - 09.05				GAS	210975	110975.0	600590	516010
						GAS	210116	110116.0	600600	516004
 † > Ch. 0116245	(932)	09.97 - 10.98				GAS	210978	110978.0	600590	516010
									600600	516010
 † Ch. 0116246 >	(932)	10.98 - 09.05				GAS	210978	110978.0	600590	516010
						GAS	210115	110115.0	600600	516004

ALFA 156 SPORTWAGON

 excl. †	(932)	05.00 - 05.06				GAS	210975	110975.0		516010
						GAS	210116	110116.0		516004
 Crosswagon 4x4 excl. † OE: 50703961	(932)	09.05 - 12.07				GAS	210979	110979.0		516010
						GAS	210117	110117.0		516004
Crosswagon 4x4 †	(932)	03.06 - 12.07				GAS	210980	110980.0		516010
						GAS	210118	110118.0		516004





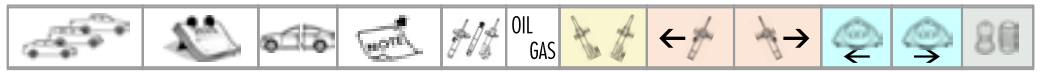







ALFA 159

 excl. †, Q4	(140)	09.05 - 11.11				GAS	210982	110982.0		516001
						GAS	210983	110983.0		516001
 Sportwagon excl. †, Q4	(140)	03.06 - 11.11				GAS	210982	110982.0		516001
						GAS	210983	110983.0		516001







ALFA ROMEO (I)





ALFA 164

 2.0 TS, 2.0 Turbo, 3.0 V6, 2.5 TD excl.  > Ch. 6183988	(164)	01.87 - 04.90		3A		GAS	210104	110104.0			516004
						GAS	210106	110106.0			516004
 2.0 TS, 2.0 Turbo, 3.0 V6, 2.5 TD excl.  Ch. 6183989 >	(164)	05.90 - 09.98		3B		GAS	210105	110105.0			516004
						GAS	210106	110106.0			516004

ALFA 166

	(936)	09.98 - 06.07				GAS	210976	110976.0	600590		516001
						GAS	210977	110977.0			516001







ALFA 1750/2000

GT, GTV, Spider	(105)	03.68 - 07.75				OIL	201239	101239.0			516004
						OIL	201241	101241.0			





ALFA SUD

1.2, 1.3, 1.5Ti Sprint, Sprint Veloce 1.3, 1.5Ti	(901) (902A)	06.72 - 12.89				OIL	200001	100001.0			516004
						OIL	201236	101236.0			
Sprint, Sprint Ti Alfa 33 susp.	(902A)	01.84 - 12.89		1A, 2		GAS	210101	110101.1	110101.2		516004
						GAS	211233	111233.0			









ALFETTA

 1.6, 1.8, 2.0, 2.0 TD  GTV 1.6, 1.8, 2.0, 2.0 Turbo, 2.5	(116)	07.74 - 12.84				OIL	201231	101231.0			
	(116)					OIL	201232	101232.0			



















ARNA

 1.2, 1.3, 1.5	(920)	10.84 - 12.86		1A, 2		GAS	210101	110101.1	110101.2		516004
						GAS	211238	111238.0			











BRERA

 excl.  , Q4	(177)	01.06 - 05.11				GAS	210984	110984.0			516001
						GAS	210985	110985.0			516001
 excl. Q4	(177)	03.06 - 05.11									

GIULIA











	(105, 115)	06.64 - 12.78				OIL	201239	101239.0			
						OIL	201241	101241.0			
 RWD excl.  ,  , 4WD	(952)	10.15 -				GAS	210989	110989.1	110989.2		516003
						GAS	211246	111246.0			516010
 4WD excl. 	(952)	08.16 -				GAS	210991	110991.1	110991.2		516003
						GAS	211247	111247.0			516010

GIULIETTA

























 1.3, 1.6, 1.8, 2.0  2.0 TD	(116)	10.77 - 12.85				OIL	201231	101231.0			
						OIL	201232	101232.0			
	(940)	04.10 -				GAS	210121	110121.1	110121.2		516004
						GAS	211245	111245.0			516010

ALFA ROMEO (I)







GT

 excl. 3.2 GTA	(937)	11.03 - 09.10				GAS	210981	110981.0	600590	516010
						GAS	210119	110119.0	600600	516004
 3.2 GTA	(937)	11.03 - 09.10				GAS	210988	110988.0	600590	516010
						GAS	210122	110122.0	600600	516004





GTV

 1.6, 1.8, 2.0, 2.0 Turbo, 2.5	(116)	07.74 - 12.84				OIL	201231	101231.0		
						OIL	201232	101232.0		
 2.0, 2.5	(116)	01.85 - 02.87				GAS	211234	111234.0		
						GAS	211235	111235.0		516010
 1.8 TS, 2.0 TS	(916C)	03.95 - 10.05		13A		GAS	210111	110111.0		516004
						GAS	211243	111243.0		
 2.0 V6 Turbo	(916C)	03.95 - 10.05		13B		GAS	210112	110112.0		516004
						GAS	211243	111243.0		
 3.0 V6	(916C)	03.95 - 10.05		13B		GAS	212145	112145.0		
						GAS	211243	111243.0		





















MITO

 excl. 1.4 Bifuel, 	(955)	08.08 -				GAS	210120	110120.1	110120.2	600500	516004
						GAS	211244	111244.0	600781	600782	516010















MONTREAL

 2.6	(105)	12.72 - 03.79				OIL	201239	101239.0		
						OIL	201241	101241.0		

SPIDER

 1.3, 1.6, 1.7, 2.0	(115)	03.66 - 12.93				OIL	201239	101239.0		
						OIL	201241	101241.0		
 1.8 TS, 2.0 TS	(916S)	09.94 - 04.05				GAS	210111	110111.0		516004
						GAS	211243	111243.0		
 2.0 Turbo V6, 3.0 V6	(916S)	09.94 - 04.05				GAS	210112	110112.0		516004
						GAS	211243	111243.0		
	(939)	06.06 - 03.11				GAS	210986	110986.0		516001
						GAS	210987	110987.0		516001

STELVIO *NEW*

 RWD excl.  ,  , 4WD	(949)	12.16 -				GAS	212208	112208.1	112208.2		516003
						GAS	212210	112210.0			516010
 4WD excl.  , 	(949)	12.16 -				GAS	212209	112209.1	112209.2		516003
						GAS	212210	112210.0			516010

AUDI (D)

50

	(86)	08.74 - 07.78		/	OIL	200002	100002.0			516004
				/	GAS	210002	110002.0			516004
				/	OIL	200993	100993.0			516010
				/	GAS	210993	110993.0			516010

80

	L, S, LS, GLS, GT	(80, 82, B1)	05.72 - 08.78		/	OIL	200003	100003.0			516004
					/	OIL	200994	100994.0			516010
	GTE	(80, 82, B1)	01.76 - 08.78		/	OIL	200003	100003.0			516004
					/	OIL	200994	100994.0			516010
	Avant	(80, 82, B1)	01.75 - 08.78		/	OIL	200003	100003.0			516004
					∅	OIL	201249	101249.0			-
	, excl. Quattro	(81, 85, B2)	09.78 - 08.86		/	GAS	210004	110004.0			516004
					/	GAS	210995	110995.0			516010
	Quattro 4X4	(81, 85, B2)	08.84 - 08.86		/	GAS	210004	110004.0			516004
					/						516004
	excl. Quattro,	(89, 89Q, 8A, B3)	06.86 - 07.91		/	GAS	210004	110004.0			516004
					/	GAS	210995	110995.0			516010
	excl. Quattro	(89, 89Q, 8A, B3)	06.86 - 07.91		/	GAS	210004	110004.0			516004
					/						516010
	Quattro 4X4	(89, 89Q, 8A, B3)	09.86 - 07.91		/	GAS	210004	110004.0			516004
					/						516004
	excl. Quattro, excl. 2.6 V6, 2.8 V6, S2,	(8C, B4)	08.91 - 09.94		/	GAS	210004	110004.0			516004
					/	GAS	210997	110997.0			516010
	2.6 V6, 2.8 V6 excl.	(8C, B4)	08.91 - 09.94		/	GAS	210004	110004.0			516004
					/	GAS	210997	110997.0			516010
		(8C, B4)	08.91 - 09.94		/	GAS	210004	110004.0			516004
					/						516010
	Quattro 4X4	(8C, B4)	08.91 - 09.94		/	GAS	210004	110004.0			516004
					∅						-
	Avant excl. 2.6 V6, 2.8 V6 excl. Quattro,	(8C, B4)	08.91 - 09.95		/	GAS	210004	110004.0			516004
					/	GAS	210997	110997.0			516010
	Avant 2.6 V6, 2.8 V6 excl. RS2,	(8C, B4)	08.91 - 09.95		/	GAS	210004	110004.0			516004
					/	GAS	210997	110997.0			516010
	Avant Quattro 4X4	(8C, B4)	08.91 - 09.95		/	GAS	210004	110004.0			516004
					∅						-
	Avant	(8C, B4)	08.91 - 09.95		/	GAS	210004	110004.0			516004
					/						516010

90

	excl. Quattro	(81, 85, B2)	10.84 - 03.87		/	GAS	210004	110004.0			516004
					/	GAS	210995	110995.0			516010
	Quattro 4X4	(81, 85, B2)	08.85 - 03.87		/	GAS	210004	110004.0			516004
					/						
	excl. 2.3, Quattro,	(89, 89Q, 8A, B3)	04.87 - 07.91		/	GAS	210004	110004.0			516004
					/	GAS	210995	110995.0			516010



AUDI (D)

excl. 2.3, Quattro	(89, 89Q, 8A, B3)	04.87 - 07.91			/	GAS	210004	110004.0			516004
					/						
Quattro 4X4	(89, 89Q, 8A, B3)	04.87 - 07.91			/	GAS	210004	110004.0			516004
					/						

100

1.6, 1.8, 2.2 Avant 1.6, 1.8, 2.2	(43, C2)	06.76 - 08.83			/	GAS	210005	110005.0			
					o	GAS	211250	111250.0			516010
excl. Quattro Avant excl. Quattro	(44, 44Q, C3)	09.82 - 10.90			/	GAS	210005	110005.0			
				excl.	/	GAS	210998	110998.0			516010
Quattro 4X4	(44, 44Q, C3)	10.84 - 10.90			/	GAS	210005	110005.0			
				excl.	/						516010
excl. Quattro, S4 V8 Avant excl. Quattro, S4 V8	(4A, C4)	11.90 - 10.94			/	GAS	210005	110005.0			
				excl.	/	GAS	210998	110998.0			516010
Quattro 4X4 excl. S4 V8 Avant Quattro 4X4 excl. S4 V8	(4A, C4)	11.90 - 10.94			/	GAS	210005	110005.0			
				excl.	/						516010

200

	(43, C2)	10.79 - 08.82			/	GAS	210005	110005.0			
					o	GAS	211250	111250.0			516010
excl. Quattro	(44, 44Q, C3)	06.83 - 10.90			/	GAS	210005	110005.0			
				excl.	/	GAS	210998	110998.0			516010
Quattro 4X4	(44, 44Q, C3)	10.84 - 10.90			/	GAS	210005	110005.0			
					/						516010

A1

excl. S line	(8X1, 8XK)	05.10 - 10.18			/	GAS	210689	110689.0	600270	516004
					o	GAS	211843	111843.0		516010
Sportback	(8XA, 8XF)	09.11 - 10.18			/	GAS	210689	110689.0	600270	516004
					o	GAS	211843	111843.0		516010

A2 (8Z0)

















1.4 16V, 1.6 16V, 1.4 Tdi excl. , 1.2 Tdi	(8Z0)	02.00 - 08.05		4A	/	GAS	210694	110694.0	600350	516004
					o	GAS	211257	111257.0		516010
1.4 16V, 1.6 16V, 1.2 Tdi, 1.4 Tdi	(8Z0)	02.00 - 08.05		4B	/	GAS	210126	110126.0		516004
					o	GAS	211257	111257.0		516010

A3 (8L1)









































excl. Quattro,	(8L1)	09.96 - 05.03			/	GAS	210124	110124.0	600270	516004
					o	GAS	211251	111251.0	600290	516010
excl. Quattro	(8L1)	09.96 - 05.03			/	GAS	210124	110124.0	600270	516004
					o	GAS	211252	111252.0	600290	516010
Quattro 4X4 excl. , S3	(8L1)	12.96 - 06.99			/	GAS	210124	110124.0	600270	516004
					o	GAS	211256	111256.0	600290	-
Quattro 4X4, excl. S3	(8L1)	07.99 - 05.03			/	GAS	210125	110125.0	600270	516004
					o	GAS	211256	111256.0	600290	-

AUDI (D)





































A3 II (8P1, 8PA)

  incl. Sportback 4X2 Quattro 4X4 excl.  , 	(8P1, 8PA)	05.03 - 08.12		5A		GAS	210776	110776.0	600430	516007
				5B		GAS	210127	110127.0		516004
	(8P1, 8PA)	05.03 - 08.12				GAS	211916	111916.0		516010
				5A		GAS	210777	110777.0	600430	516007
  excl. 	(8P1, 8PA)	05.03 - 08.12		5B		GAS	210128	110128.0		
						GAS	211260	111260.0		516010













A3 III (8V1, 8VK, 8VA, 8VF, 8VS, 8VM)

 excl. 4X4, S3, 	(8V1, 8VK)	04.12 -		5A		GAS	210785	110785.0		516007
				5B		GAS	210784	110784.0		516004
 4X4 excl. S3, 	(8V1, 8VK)	08.12 -				GAS	211924	111924.0		516010
				5A		GAS	210785	110785.0		516007
 4X4 excl. S3, 	(8V1, 8VK)	08.12 -		5B		GAS	210784	110784.0		516004
						GAS	211925	111925.0		516010
 Sportback excl. 4X4, S3, 	(8VA, 8VF)	09.12 -		5A		GAS	210785	110785.0		516007
				5B		GAS	210784	110784.0		516004
	(8VA, 8VF)	09.12 -				GAS	211924	111924.0		516010
				5A		GAS	210785	110785.0		516007
 Sportback 4X4 excl. S3, 	(8VA, 8VF)	02.13 -		5B		GAS	210784	110784.0		516004
						GAS	211925	111925.0		516010
 Limousine excl. 4X4, S3, 	(8VS, 8VM)	05.13 -		5A		GAS	210785	110785.0		516007
				5B		GAS	210784	110784.0		516004
	(8VS, 8VM)	05.13 -				GAS	211924	111924.0		516010
				5A		GAS	210785	110785.0		516007
 Limousine 4X4 excl. S3, 	(8VS, 8VM)	10.13 -		5B		GAS	210784	110784.0		516004
						GAS	211925	111925.0		516010

A4 (8D2, 8D5, B5)

























  excl. Quattro, 	(8D2, 8D5, B5)	10.94 - 01.99				GAS	210999	110999.0	600060	516001
						GAS	211000	111000.0		516010
  excl. Quattro, 	(8D2, 8D5, B5)	02.99 - 10.00				GAS	210999	110999.0	600060	516001
						GAS	211006	111006.0		516010
   excl. Quattro	(8D2, 8D5, B5)	10.94 - 01.99				GAS	211001	111001.0	600060	516001
						GAS	211000	111000.0		516010
   excl. Quattro	(8D2, 8D5, B5)	02.99 - 10.00				GAS	211001	111001.0	600060	516001
						GAS	211006	111006.0		516010
  Quattro 4X4 excl. 	(8D2, 8D5, B5)	10.94 - 10.00				GAS	210999	110999.0	600060	516001
						GAS	211007	111007.0		-
  Quattro 4X4, 	(8D2, 8D5, B5)	10.94 - 10.00				GAS	211001	111001.0	600060	516001
						GAS	211007	111007.0		-

A4 II (8E2, 8E5, B6)













 excl.  , 	(8E2, 8E5, B6)	11.00 - 12.04				GAS	211004	111004.0	600760	516001
						GAS	211258	111258.0		516010
  excl. 	(8E2, 8E5, B6)	11.00 - 12.04				GAS	211005	111005.0	600760	516001
						GAS	211259	111259.0		516010

AUDI (D)













A4 III (8EC, 8ED, B7)

 excl. 	(8EC, 8ED, B7)	11.04 - 06.08				GAS	211012	111012.0	600760	516001
						GAS	211261	111261.0		516010
 	(8EC, 8ED, B7)	11.04 - 06.08				GAS	211016	111016.0		516001
						GAS	211263	111263.0		516010
 Quattro excl. 	(8EC, 8ED, B7)	11.04 - 06.08				GAS	211013	111013.0	600760	516001
						GAS	211263	111263.0		516010
 Quattro 	(8EC, 8ED, B7)	11.04 - 06.08				GAS	211013	111013.0	600760	516001
						GAS	211265	111265.0		516010













A4 IV (8K2, 8K5, B8) EXCL. ALLROAD

 excl. 	(8K2, 8K5, B8)	11.07 - 12.15				GAS	211018	111018.0		516003
						GAS	211264	111264.0		516010
 	(8K2, 8K5, B8)	11.07 - 12.15				GAS	211021	111021.0		516003
						GAS	211266	111266.0		516010













A4 V (8W2, 8W5, 8WC, 8WD, B9) EXCL. ALLROAD *NEW*

 ø53 excl. 	(8W2, 8W5, 8WC, 8WD, B9)	05.15 -				GAS	212153	112153.0		516003
						GAS	212155	112155.0		516001
 ø49 excl. 	(8W2, 8W5, 8WC, 8WD, B9)	05.15 -				GAS	212154	112154.0		516003
						GAS	212155	112155.0		516001

























A5 (8T3, 8TA, 8F7)

 excl. 	(8T3, 8TA, 8F7)	06.07 - 01.17				GAS	211018	111018.0		516003
						GAS	211264	111264.0		516010
 	(8T3, 8TA, 8F7)	06.07 - 01.17				GAS	211021	111021.0		516003
						GAS	211266	111266.0		516010

A5 II (F53, F57, F5A, F5E, F5F, F5P) *NEW*

 ø53 excl. 	(F53, F57, F5A, F5E, F5F, F5P)	06.16 -				GAS	212153	112153.0		516003
						GAS	212155	112155.0		516001
 ø49 excl. 	(F53, F57, F5A, F5E, F5F, F5P)	06.16 -				GAS	212154	112154.0		516003
						GAS	212155	112155.0		516001

A6 (4A2, 4A5, C4)

 excl. Quattro,  , S6	(4A2, 4A5, C4)	06.94 - 02.97				GAS	210005	110005.0		516004
						GAS	210998	110998.0		516001
 Avant excl. Quattro,  , S6	(4A2, 4A5, C4)	06.94 - 12.97				GAS	210005	110005.0		516004
						GAS	210998	110998.0		516001
 Quattro excl. S6, 	(4A2, 4A5, C4)	06.94 - 12.97				GAS	210005	110005.0		516004
						GAS	211019	111019.0		516001
 Quattro  excl. S6,	(4A2, 4A5, C4)	06.94 - 12.97				GAS	210005	110005.0		516004
						GAS	211020	111020.0		516001

AUDI (D)

A6 II (4B2, 4B5, C5)

excl. Quattro,	(4B2, C5)	01.97 - 01.99				GAS	211002	111002.0	600060	516001
						GAS	211253	111253.0		516010
excl. Quattro, > Ch. 4B-X-070000	(4B5, C5)	12.97 - 01.99				GAS	211002	111002.0	600060	516001
						GAS	211253	111253.0		516010
excl. Quattro > Ch. 4B-X-070000	(4B2, 4B5, C5)	05.97 - 01.99				GAS	211001	111001.0	600060	516001
						GAS	211253	111253.0		516001
Quattro 4X4 > Ch. 4B-X-070000	(4B2, 4B5, C5)	05.97 - 01.99				GAS	211002	111002.0	600060	516001
						GAS	211010	111010.0		516010
excl. Quattro, Ch. 4B-X-070001 > Ch. 4B-Y-200000	(4B2, 4B5, C5)	01.99 - 04.00				GAS	211002	111002.0	600060	516001
						GAS	211253	111253.0		516010
excl. Quattro Ch. 4B-X-070001 > Ch. 4B-Y-200000	(4B2, 4B5, C5)	01.99 - 04.00				GAS	211001	111001.0	600060	516001
						GAS	211253	111253.0		516001
Quattro 4X4 Ch. 4B-X-070001 > Ch. 4B-Y-200000	(4B2, 4B5, C5)	01.99 - 04.00				GAS	211002	111002.0	600060	516001
						GAS	211010	111010.0		516010
excl. Quattro, Ch. 4B-1-000001 >	(4B2, 4B5, C5)	05.00 - 04.04				GAS	211008	111008.0	600060	516001
						GAS	211253	111253.0		516010
excl. Quattro Ch. 4B-1-000001 >	(4B2, 4B5, C5)	05.00 - 04.04				GAS	211009	111009.0	600060	516001
						GAS	211253	111253.0		516010
Quattro 4X4 excl. Ch. 4B-1-000001 >	(4B2, 4B5, C5)	05.00 - 04.04				GAS	211008	111008.0	600060	516001
						GAS	211011	111011.0		516001

A6 III (4F2, 4F5, C6) EXCL. ALLROAD

excl. Quattro,	(4F2, C6)	05.04 - 03.11				GAS	211014	111014.0		516001
						GAS	211262	111262.0		516010
excl. Quattro,	(4F5, C6)	03.05 - 08.11				GAS	211014	111014.0		516001
						GAS	211262	111262.0		516010
excl. Quattro	(4F2, C6)	05.04 - 03.11				GAS	211017	111017.0		516001
						GAS	211262	111262.0		516010
excl. Quattro	(4F5, C6)	03.05 - 08.11				GAS	211017	111017.0		516001
						GAS	211262	111262.0		516010
Quattro excl.	(4F2, C6)	05.04 - 03.11				GAS	211015	111015.0		516001
						GAS	211262	111262.0		516010
Quattro excl.	(4F5, C6)	03.05 - 08.11				GAS	211015	111015.0		516001
						GAS	211262	111262.0		516010

A6 IV (4G2, 4G5, 4GC, 4GD, C7) EXCL. ALLROAD

















excl.	(4G2, C7, 4GC)	11.10 - 09.18				GAS	211021	111021.0		516003
						GAS	211266	111266.0		516010
excl.	(4G5, C7, 4GD)	05.11 - 09.18				GAS	211021	111021.0		516003
						GAS	211266	111266.0		516010
	(4G2, C7, 4GC)	11.10 - 09.18								516003
	(4G5, C7, 4GD)	05.11 - 09.18								516003

A7 SPORT BACK (4GA)







excl.	(4G2, C7, 4GC)	11.10 - 09.18				GAS	211021	111021.0		516003
						GAS	211266	111266.0		516010







AUDI (D)

 excl. 	(4G5, C7, 4GD)	05.11 - 09.18				GAS	211021	111021.0			516003
							GAS	211266	111266.0		
	(4G2, C7, 4GC)	11.10 - 09.18									516003
											
	(4G5, C7, 4GD)	05.11 - 09.18									516003
											



























A8 (4D2, 4D8)

 excl. 	(4D2, 4D8)	03.94 - 09.02				GAS	211003	111003.0	600060		
							GAS	211254	111254.0		















CABRIOLET

	(8G7, B4)	05.91 - 08.00				GAS	210004	110004.0			516004
											













COUPÈ

 excl. Quattro	(81, 85)	08.80 - 09.88				GAS	210004	110004.0			516004
							GAS	210995	110995.0		
 excl. Quattro, S2	(89, 8B)	10.88 - 07.91				GAS	210004	110004.0			516004
											
 Quattro 4X4	(81, 85, 89, 8B)	01.84 - 07.91				GAS	210004	110004.0			516004
											
 excl. Quattro, S2, 	(89, 8B)	08.91 - 12.96				GAS	210004	110004.0			516004
											
 Quattro 4X4	(89, 8B)	08.91 - 12.96				GAS	210004	110004.0			516004
											













Q2 (GAB) *NEW*

 excl. S, RS,  ,  , multilink	(GAB)	06.16 -				GAS	212156	112156.0			516007
							GAS	212157	112157.0		
 multilink excl. S, RS,  , 	(GAB)	06.16 -				GAS	212156	112156.0			516007
							GAS	212217	112217.0		

Q3 (8UB, 8UG)

 excl. RS, 	(8UB, 8UG)	06.11 - 10.18				GAS	210782	110782.0	600430		516007
							GAS	211922	111922.0		
 excl. RS, 	(F3B)	06.11 - 10.18				GAS	210782	110782.0	600430		516007
							GAS	211922	111922.0		



































Q5 (8RB)

 excl. S	(8RB)	11.08 - 05.17				GAS	211018	111018.0			516003
							GAS	211264	111264.0		
 excl. S,  ,  *NEW*	(FYB)	06.16 -				GAS	212153	112153.0			516003
							GAS	212155	112155.0		







AUDI (D)

TT























 4X2 excl.  3.2 V6	(8N3, 8N9)	10.98 - 10.06			GAS	210125	110125.0	600270	516004
					GAS	211255	111255.0	600290	516010
 Quattro 4X4 excl.  3.2 V6	(8N3, 8N9)	10.98 - 10.06			GAS	210125	110125.0	600270	516004
					GAS	211256	111256.0	600290	-
 excl. S line	(8J3)	10.06 - 06.14			GAS	210129	110129.0	600430	516007
					GAS	211267	111267.0		516010
 excl. S line	(8J9)	02.07 - 06.14			GAS	210129	110129.0	600430	516007
					GAS	211267	111267.0		516010
 excl. 	(FV3, FVP)	07.14 -			GAS	210785	110785.0		516007
					GAS	211925	111925.0		516010
 excl. 	(FV9, FVR)	11.14 -			GAS	210785	110785.0		516007
					GAS	211925	111925.0		516010

V8





 3.6, 4.2	(D1)	10.88 - 02.94			GAS	210005	110005.0		516004
									

AUSTIN (GB)



















MAESTRO

 excl. 2.0 MG EFI, Turbo, 	(XC)	03.83 - 09.92		6A		GAS	210130	110130.0			
				6B		GAS	210131	110131.0			
				6D		GAS	211022	111022.0			
				6E		GAS	211023	111023.0			
 2.0 MG EFI, Turbo	(XC)	10.84 - 08.90		6A		GAS	210130	110130.0			
				6B		GAS	210131	110131.0			
				6D		GAS	211022	111022.0			
				6E		GAS	211023	111023.0			
	(XC)	1985 - 1990				OIL	200132	100132.0			
						OIL	201268	101268.0			
	(XC)	1990 - 1994		6C		OIL	200132	100132.0			
						OIL	201269	101269.0			

























METRO

		10.80 - 04.90				OIL	201270	101270.0			
											

MINI

 0.85, Cooper, Cooper S  0.85, 1.0, 1.1, 1.3, GT, Cooper		1965 - 1969				OIL	201271	101271.0			-
		1970 - 1981				OIL	201273	101273.0			
 Innocenti		1974 - 1981				OIL	201271	101271.0			-
						OIL	201273	101273.0			
 ,  , 		1961 - 1981				OIL	201271	101271.0			-
						OIL	201272	101272.0			
		1961 - 1981				OIL	201271	101271.0			-
											



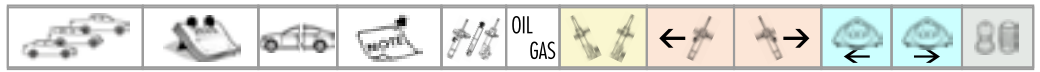

MONTEGO

 excl. 2.0 MG Turbo, 	(XE)	04.84 - 12.94		6A		GAS	210130	110130.0			
				6B		GAS	210131	110131.0			
				6D		GAS	211022	111022.0			
				6E		GAS	211023	111023.0			
 2.0 MG Turbo excl. 	(XE)	1985 - 02.87		6A		GAS	210130	110130.0			
						GAS	211024	111024.0			
 2.0 MG Turbo 		03.87 - 1994		6B		GAS	210131	110131.0			
 excl. 	(XE)	10.84 - 12.94		6A		GAS	210130	110130.0			
				6B		GAS	210131	110131.0			
						GAS					
						GAS					



























AUTOBIANCHI (I)

A 112







ch. 47201>		10.69 - 12.85			OIL	200133	100133.0			
					OIL	200134	100134.0			

Y 10

















4X2	(156)	03.85 - 12.92			OIL	200135	100135.1	100135.2			516004
					GAS	210135	110135.1	110135.2			
					OIL	201274	101274.0				-
					GAS	211274	111274.0				-
4X2	(156)	01.93 - 10.95			OIL	200135	100135.1	100135.2			516004
					GAS	210135	110135.1	110135.2			
					OIL	201276	101276.0				-
					GAS	211276	111276.0				-
4X4	(156)	12.86 - 04.91			OIL	200135	100135.1	100135.2			516004
					GAS	210135	110135.1	110135.2			
					OIL	201275	101275.0				-
					GAS	211275	111275.0				-
4X4	(156)	06.89 - 10.95			OIL	200135	100135.1	100135.2			516004
					GAS	210135	110135.1	110135.2			
					OIL	201277	101277.0				-
					GAS	211277	111277.0				-

BEDFORD (GB)



ASTRA

Astra		1982 - 1984		/	GAS	210046	110046.0			
					OIL	201678	101678.0			
Astra		1984 - 07.91		/	OIL	210046	110046.0			
					OIL	201664	101664.0			
 AstraMax		1985 - 07.91		/	OIL	210046	110046.0			
					OIL	201679	101679.0			



CF

14, 18, 22, 25, 35 CWT		1970 - 1975		+	OIL	201665	101665.0			
					OIL	201312	101312.0			
220, 250, 280, 340		1976 - 1982		+	OIL	201665	101665.0			
					OIL	201666	101666.0			
350		1976 -		+	OIL	201665	101665.0			
										
CF 18, 22, 25 CWT		1984 -		+	OIL	201313	101313.0			
					OIL	201665	101665.0			
					OIL	201377	101377.0			
35 CWT		1983 - 1984		+	OIL	201665	101665.0			
					OIL	201666	101666.0			
35 CWT		1984 -		+	OIL	201313	101313.0			
					OIL	201666	101666.0			
CF 97170/97370				+	OIL	201313	101313.0			
					OIL	201665	101665.0			
					OIL	201377	101377.0			
CF 97170/97370				+	OIL	201313	101313.0			
					OIL	201665	101665.0			
					OIL	201666	101666.0			







CHEVANNE

9 CWT		06.76 - 12.82		+	GAS	201661	101661.0			
					GAS	211674	111674.0			







KB

		05.72 - 12.88		+	GAS	211489	111489.0			
					GAS	211596	111596.0			

MIDI

 4X2		09.84 - 08.92		+	OIL	201311	101311.0			
					GAS	211499	111499.0			
 4X4		09.84 - 08.92		+						
					GAS	211499	111499.0			

RASCAL

		07.86 - 06.90		+	OIL	200178	100178.1	100178.2		
					OIL	201314	101314.0			
 		07.86 - 06.90		+	OIL	200178	100178.1	100178.2		
					OIL	201315	101315.0			

BMW (D)

1 SERIES (E81, E82, E87, E88)

116i, 118i, 120i, 130i excl. 116d, 118d, 120d, 123d excl.	(E81, E87)	09.04 - 09.12				GAS	210190	110190.1	110190.2	600900	516004
						GAS	211325	111325.0		600890	516001
120i, 125i, 135i, 118d, 120d, 123d excl. 3.0 M,	(E82)	10.07 - 10.13				GAS	210190	110190.1	110190.2	600900	516004
						GAS	211325	111325.0		600890	516001
118i, 120i, 125i, 135i, 118d, 120d, 123d excl.	(E88)	03.08 - 12.13				GAS	210190	110190.1	110190.2	600900	516004
						GAS	211325	111325.0		600890	516001

1 SERIES (F20, F21) EXCL. M-TECHNIK

excl. , xDrive	(F20)	07.11 - 06.19				GAS	210945	110945.0			516004
						GAS	212065	112065.0			516001
excl. , xDrive	(F21)	12.11 -				GAS	210945	110945.0			516004
						GAS	212065	112065.0			516001

1 SERIES (F40) EXCL. M-TECHNIK

excl. , xDrive	(F40)	07.19 -				GAS	212218	112218.1	112218.2		516004
						GAS	212219	112219.0			516001

2 SERIES (F22, F87, F23) EXCL. M-TECHNIK

excl.	(F22, F87)	10.12 -				GAS	210945	110945.0			516004
						GAS	212065	112065.0			516001
excl.	(F23)	03.14 -				GAS	210945	110945.0			516004
						GAS	212065	112065.0			516001

2 SERIES ACTIVE TOURER (F45) *NEW*

excl.	(F45)	11.13 -				GAS	210949	110949.1	110949.2		516004
						GAS	212069	112069.0			516001

2 SERIES GRAN TOURER (F46) *NEW*

excl.	(F46)	07.14 -				GAS	210949	110949.1	110949.2		516004
						GAS	212069	112069.0			516001

3 SERIES (E21)

excl. 323i,	(E21)	06.75 - 08.82				OIL	200008	100008.0			516004
						OIL	201026	101026.0			
 323i	(E21)	06.75 - 08.82 09.77 - 08.82				GAS	210009	110009.0			516004
						GAS	211026	111026.0			

3 SERIES (E30) EXCL. M-TECHNIK

316, 318, 320, 324 D excl.	(E30)	09.82 - 09.87		7A		GAS	210010	110010.0			516004
						GAS	211317	111317.0		600320	
316, 318, 320, 324 D 	(E30)	09.82 - 09.87		7B		GAS	210011	110011.0			516004
						GAS	211317	111317.0		600320	
323i 325e, 325i	(E30)	09.82 - 09.87 02.85 - 09.87		7B		GAS	210011	110011.0			516004
						GAS	211317	111317.0		600320	
325iX 4X4 excl.	(E30)	09.85 - 08.91									516004
						GAS	211317	111317.0		600320	

BMW (D)

↻ 318i, 320i, 325i	(E30)	12.85 - 10.93		7B	/	GAS	210011	110011.0			516004
					∅	GAS	211317	111317.0	600320		
↻ 316i, 318i, 318is, 320i, 324 D excl. ❏	(E30)	10.87 - 08.90		7A	/	GAS	210010	110010.0			516004
					∅	GAS	211317	111317.0	600320		
↻ 316i, 318i, 318is, 320i, 324 D ❏	(E30)	10.87 - 08.90		7B	/	GAS	210011	110011.0			516004
					∅	GAS	211317	111317.0	600320		
↻ 320is, 325i, 325e ↻ 324 TD	(E30)	10.87 - 08.90 10.87 - 08.90		7B	/	GAS	210011	110011.0			516004
					∅	GAS	211317	111317.0	600320		
↻ Touring 316i excl. ❏ ↻ Touring 318i excl. ❏	(E30)	10.87 - 06.94 10.87 - 06.94		7A	/	GAS	210010	110010.0			516004
					∅	GAS	211317	111317.0	600320		
↻ Touring 318is, 320i, 320is, 325i, 325is ↻ Touring 324 TD	(E30)	10.87 - 06.94 10.87 - 06.94		7B	/	GAS	210011	110011.0			516004
					∅	GAS	211317	111317.0	600320		

3 SERIES (E36) EXCL. M-TECHNIK







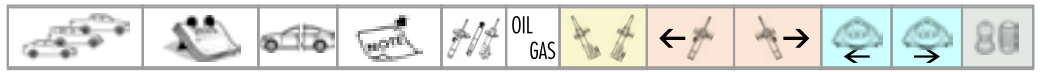











































↻ 316i, 318i, ↻ 318is	(E36)	11.90 - 05.92		8A	↗	GAS	210179	110179.1	110179.2			516004
					∅	GAS	211318	111318.0		600320		516010
↻ 320i, 325i, 325 TD, ↻ 320i, 325i	(E36)	11.90 - 05.92		8B	↗	GAS	210180	110180.1	110180.2			516004
					∅	GAS	211318	111318.0		600320		516010
↻ 316i, 318i, 318is, 318 TDS	(E36)	06.92 - 02.98		8C	↗	GAS	210181	110181.1	110181.2			516004
					∅	GAS	211318	111318.0		600320		516010
↻ 320i, 323i, 325i, 328i, 325 TD, 325 TDS	(E36)	06.92 - 02.98		8D	↗	GAS	210182	110182.1	110182.2			516004
					∅	GAS	211318	111318.0		600320		516010
↻ 316i, 318is	(E36)	06.92 - 02.98		8C	↗	GAS	210181	110181.1	110181.2			516004
					∅	GAS	211318	111318.0		600320		516010
↻ 320i, 323i, 325i, 328i	(E36)	06.92 - 02.98		8D	↗	GAS	210182	110182.1	110182.2			516004
					∅	GAS	211318	111318.0		600320		516010
↻ Compact 316i, 318Ti, 318 TDS	(E36)	03.94 - 08.00		8C	↗	GAS	210181	110181.1	110181.2			516004
					∅	GAS	211319	111319.0				516001
↻ 318i, 320i, 323i, 325i, 328i	(E36)	03.93 - 04.99		8D	↗	GAS	210182	110182.1	110182.2			516004
					∅	GAS	211318	111318.0		600320		516010
↻ Touring 316i, 318i, 320i, 325i, 328i, 325 TD, 325 TDS	(E36)	01.95 - 10.99		8C	↗	GAS	210181	110181.1	110181.2			516004
					∅	GAS	211320	111320.0				516001

3 SERIES (E46) 4X2





















↻ 316i, 318i, 320i excl. ❏, M-Sport Pack II	(E46)	02.98 - 09.01			↗	GAS	210185	110185.1	110185.2	600240		516004
					∅	GAS	211318	111318.0		600320		516010
↻ 316i, 318i, 318d excl. ❏, M-Sport Pack II	(E46)	09.01 - 04.05			↗	GAS	210191	110191.1	110191.2	600240		516004
					∅	GAS	211318	111318.0		600320		516010
↻ 320i, 320d, 325i excl. ❏, M-Sport Pack II	(E46)	09.01 - 04.05			↗	GAS	210192	110192.1	110192.2	600240		516004
					∅	GAS	211332	111332.0		600320		516001
↻ 330i, 330d incl. ❏	(E46)	06.00 - 04.05			↗	GAS	210186	110186.1	110186.2	600240		516004
					∅	GAS	211331	111331.0		600320		516001
↻ 316i, 318i, 320i, 325i ❏, excl. M-Sport Pack II	(E46)	02.98 - 09.01			↗	GAS	210193	110193.1	110193.2	600240		516004
					∅	GAS	211329	111329.0		600320		516001
↻ 320d ❏, excl. M-Sport Pack II	(E46)	02.98 - 09.01			↗	GAS	210186	110186.1	110186.2	600240		516004
					∅	GAS	211331	111331.0		600320		516001
↻ 316i, 318i, 318d ❏, excl. M-Sport Pack II	(E46)	09.01 - 04.05			↗	GAS	210193	110193.1	110193.2	600240		516004
					∅	GAS	211329	111329.0		600320		516001
↻ 320i, 325i, 320d ❏, excl. M-Sport Pack II	(E46)	09.01 - 04.05			↗	GAS	210197	110197.1	110197.2	600240		516004
					∅	GAS	211331	111331.0		600320		516001



BMW (D)

316Ci, 318Ci excl. M-Sport Pack II	(E46)	04.00 - 04.05				GAS	210193	110193.1	110193.2	600240	516004
320Ci excl. M-Sport Pack II	(E46)	04.99 - 04.01				GAS	210192	110192.1	110192.2	600240	516004
320 Ci excl. M-Sport Pack II	(E46)	04.01 - 09.01				GAS	210192	110192.1	110192.2	600240	516004
320 Ci excl. M-Sport Pack II	(E46)	10.01 - 04.05				GAS	210197	110197.1	110197.2	600240	516004
323Ci, 325Ci, 328Ci excl. M-Sport Pack II	(E46)	04.99 - 09.01				GAS	210192	110192.1	110192.2	600240	516004
330Ci excl. M-Sport Pack II	(E46)	06.00 - 04.01				GAS	210192	110192.1	110192.2	600240	516004
330Ci excl. M-Sport Pack II	(E46)	04.01 - 09.01				GAS	210192	110192.1	110192.2	600240	516004
330Ci, 330Cd excl. M-Sport Pack II	(E46)	09.01 - 04.05 03.03 - 04.05				GAS	210197	110197.1	110197.2	600240	516004
320Ci, 325Ci, 330Ci M-Sport Pack II	(E46)	04.99 - 09.01				GAS	211331	111331.0		600320	516001
320Ci, 325Ci, 330Ci M-Sport Pack II	(E46)	09.01 - 04.05				GAS	210186	110186.1	110186.2	600240	516004
323Ci, 328Ci M-Sport Pack II	(E46)	04.99 - 09.00				GAS	210186	110186.1	110186.2	600240	516004
Touring 316i, 318i, 318d excl. M-Sport Pack II	(E46)	10.99 - 02.05				GAS	210191	110191.1	110191.2	600240	516004
Touring 320i, 323i, 325i, 328i, 330i Touring 320d, 330d excl. M-Sport Pack II	(E46)	10.99 - 02.05 03.00 - 02.05				GAS	210192	110192.1	110192.2	600240	516004
Touring 316i, 318i, 320i, 323i, 325i, 328i, 330i Touring 318d, 320d, 330d M-Sport Pack II	(E46)	10.99 - 02.05 10.99 - 02.05				GAS	210193	110193.1	110193.2	600240	516004
318Ci, 320Ci, 323Ci, 325Ci, 330Ci, 320Cd excl. M-Sport Pack II	(E46)	04.00 - 04.05				GAS	210192	110192.1	110192.2	600240	516004
318Ci, 320Ci, 323Ci, 325Ci, 330Ci, 320Cd M-Sport Pack II	(E46)	04.00 - 09.01				GAS	210193	110193.1	110193.2	600240	516004
318Ci, 320Ci, 323Ci, 325Ci, 330Ci, 320Cd M-Sport Pack II	(E46)	09.01 - 04.05				GAS	210186	110186.1	110186.2	600240	516004

3 SERIES COMPACT (E46)

316ti, 318ti excl. M-Sport Pack II	(E46)	06.01 - 02.05				GAS	210185	110185.1	110185.2	600240	516004
325ti, 320td excl. M-Sport Pack II	(E46)	06.01 - 02.05				GAS	210192	110192.1	110192.2	600240	516004
316ti, 318ti M-Sport Pack II	(E46)	06.01 - 03.02				GAS	210185	110185.1	110185.2	600240	516004
316ti, 318ti M-Sport Pack II	(E46)	03.02 - 03.03				GAS	210192	110192.1	110192.2	600240	516004
316ti, 318ti M-Sport Pack II	(E46)	03.03 - 02.05				GAS	210193	110193.1	110193.2	600240	516004
325ti, 320td M-Sport Pack II	(E46)	06.01 - 09.01				GAS	210186	110186.1	110186.2	600240	516004
325ti, 320td M-Sport Pack II	(E46)	09.01 - 02.05				GAS	210197	110197.1	110197.2	600240	516004

BMW (D)

3 SERIES (E90) EXCL. M-TECHNIK

316i, 320i, 320d, 323i, 325i excl. xi, xd, xDrive,	(E90)	01.05 - 12.11				GAS	210198	110198.1	110198.2	600905	516004
						GAS	211333	111333.0			516001

3 SERIES TOURING (E91) EXCL. M-TECHNIK

320i, 325i, 330i excl. xi, xd, xDrive,	(E91)	01.05 - 06.12				GAS	210198	110198.1	110198.2	600905	516004
		09.05 - 06.12				GAS	211333	111333.0			516001

3 SERIES COUPE' (E92) EXCL. M-TECHNIK

320i, 325i, 330i, 335i excl. xi, xd, xDrive,	(E92)	06.06 - 12.13				GAS	210198	110198.1	110198.2	600905	516004
						GAS	211333	111333.0			516001

3 SERIES CABRIOLET (E93) EXCL. M-TECHNIK

320i, 325i, 330i, 335i excl. xi, xd, xDrive,	(E93)	08.06 - 12.13				GAS	210198	110198.1	110198.2	600905	516004
						GAS	211333	111333.0			516001

3 SERIES (F30, F80)

excl. xDrive, Active Hybrid	(F30, F80)	11.11 - 10.18				GAS	210946	110946.0			516004
						GAS	212066	112066.0			516001

3 SERIES TOURING (F31)

excl. xDrive, Active Hybrid	(F31)	07.12 - 06.19				GAS	210946	110946.0			516004
						GAS	212066	112066.0			516001

3 SERIES GRAN TURISMO (F34)

excl. xDrive, Active Hybrid	(F34)	11.12 -				GAS	210946	110946.0			516004
						GAS	212066	112066.0			516001

3 SERIES (G20) EXCL. M-TECHNIK *NEW*

excl. xDrive, M	(G20)	11.18 -				GAS	212220	112220.1	112220.2		516004
						GAS	212221	112221.0			516001

3 SERIES TOURING (G21) EXCL. M-TECHNIK *NEW*

excl. xDrive, M	(G21)	07.19 -				GAS	212220	112220.1	112220.2		516004
						GAS	212221	112221.0			516001

4 SERIES (F32, F33, F36, F82, F83)

excl. xDrive,	(F32, F82)	07.13 -				GAS	210946	110946.0			516004
						GAS	212066	112066.0			516001
excl. xDrive,	(F33, F83)	10.13 -				GAS	210946	110946.0			516004
						GAS	212066	112066.0			516001
Gran coupè excl. xDrive,	(F36)	03.14 -				GAS	210946	110946.0			516004
						GAS	212066	112066.0			516001

5 SERIES (E12)

518, 520, 520A, 520i, 525	(E12)	08.72 - 07.76				GAS	210007	110007.0			516004



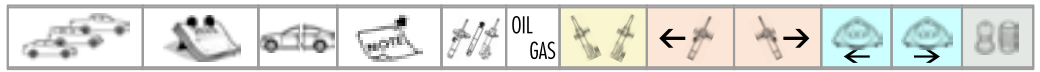

BMW (D)

518, 520, 520A, 520i, 518i, 520/6, 525 525i, 528, 528A, 528i, 528iA, 530i, 530iA	(E12)	08.76 - 06.81			/	GAS	210007	110007.0			516004
					≠	GAS	211027	111027.0			

5 SERIES (E28) EXCL. M-TECHNIK

518, 518i, 520i, 525i, 528i 524 D, 524 TD, 525e	(E28)	07.81 - 12.87			/	GAS	210012	110012.0			516004
					≠	GAS	211028	111028.0			

5 SERIES (E34) EXCL. M-TECHNIK

518i excl. , ,	(E34)	01.88 - 07.90		9A	/	GAS	210013	110013.0			516004
					≠	GAS	211029	111029.0			516010
518i excl. ,	(E34)	01.88 - 07.90		9C	/	GAS	210014	110014.0			516004
					≠	GAS	211029	111029.0			516010
518i excl. , ,	(E34)	08.90 - 09.95		9B	/	GAS	210020	110020.0			516004
					≠	GAS	211029	111029.0			516010
518i excl. ,	(E34)	08.90 - 08.92		9D	/	GAS	210015	110015.0			516004
					≠	GAS	211029	111029.0			516010
518i excl. ,	(E34)	09.92 - 09.95		9B	/	GAS	210020	110020.0			516004
					≠	GAS	211029	111029.0			516010
520i excl. , ,	(E34)	01.88 - 07.90		9A	/	GAS	210013	110013.0			516004
					≠	GAS	211029	111029.0			516010
520i excl. ,	(E34)	01.88 - 07.90		9C	/	GAS	210014	110014.0			516004
					≠	GAS	211029	111029.0			516010
520i excl. , ,	(E34)	08.90 - 09.95		9B	/	GAS	210020	110020.0			516004
					≠	GAS	211029	111029.0			516010
520i excl. ,	(E34)	08.90 - 08.92		9D	/	GAS	210015	110015.0			516004
					≠	GAS	211029	111029.0			516010
520i excl. ,	(E34)	09.92 - 09.95		9B	/	GAS	210020	110020.0			516004
					≠	GAS	211029	111029.0			516010
525i excl. ,	(E34)	01.88 - 07.90		9C	/	GAS	210014	110014.0			516004
					≠	GAS	211029	111029.0			516010
525i excl. ,	(E34)	08.90 - 08.92		9D	/	GAS	210015	110015.0			516004
					≠	GAS	211029	111029.0			516010
525i excl. ,	(E34)	09.92 - 09.95		9B	/	GAS	210020	110020.0			516004
					≠	GAS	211029	111029.0			516010
525iX excl. ,	(E34)	05.91 - 09.95			/						516004
					≠	GAS	211029	111029.0			516010
530i excl. ,	(E34)	01.88 - 07.90		9C	/	GAS	210014	110014.0			516004
					≠	GAS	211029	111029.0			516010
530i excl. ,	(E34)	08.90 - 09.95		9D	/	GAS	210015	110015.0			516004
					≠	GAS	211029	111029.0			516010
535i excl. ,	(E34)	01.88 - 07.90		9C	/	GAS	210014	110014.0			516004
					≠	GAS	211029	111029.0			516010
535i, 540i excl. ,	(E34)	08.90 - 09.95		9D	/	GAS	210015	110015.0			516004
					≠	GAS	211029	111029.0			516010
524 TD excl. ,	(E34)	01.88 - 07.90		9C	/	GAS	210014	110014.0			516004
					≠	GAS	211029	111029.0			516010
524 TD excl. ,	(E34)	08.90 - 08.92		9D	/	GAS	210015	110015.0			516004
					≠	GAS	211029	111029.0			516010
525 TD, 525 TDS excl. ,	(E34)	08.90 - 08.92		9D	/	GAS	210015	110015.0			516004
					≠	GAS	211029	111029.0			516010



BMW (D)

525 TD, 525 TDS excl. ,	(E34)	09.92 - 09.95		9B	/	GAS	210020	110020.0			516004
					/	GAS	211029	111029.0			516010
Touring 518i, 520i excl. ,	(E34)	08.91 - 01.97		9B	/	GAS	210020	110020.0			516004
					/	GAS	211029	111029.0			516010
Touring 518i, 520i excl. ,	(E34)	08.91 - 01.97		9C	/	GAS	210015	110015.0			516004
					/	GAS	211029	111029.0			516010
Touring 525i excl. ,	(E34)	08.91 - 01.97		9D	/	GAS	210015	110015.0			516004
Touring 530i, 535i, 540i excl. ,	(E34)	08.91 - 01.97		9D	/	GAS	210015	110015.0			516004
Touring 524 TD excl. ,	(E34)	08.91 - 01.97		9B	/	GAS	210020	110020.0			516004
					/	GAS	211029	111029.0			516010
Touring 524 TD Touring 525 TDS excl. ,	(E34)	08.91 - 01.97		9D	/	GAS	210015	110015.0			516004
					/	GAS	211029	111029.0			516010

5 SERIES (E39) EXCL. M-TECHNIK

520i, 523i, 525i, 525 TDS, 528i, 530D excl.	(E39)	11.95 - 06.03			/	GAS	210183	110183.0	600240	516004
					/	GAS	211032	111032.0		
535i, 540i excl.	(E39)	11.95 - 06.03			/	GAS	210184	110184.0	600240	516004
					/	GAS	211032	111032.0		
Touring 520i, 523i, 525i, 525 TDS, 528i, 530D excl.	(E39)	01.97 - 05.04			/	GAS	210183	110183.0	600240	516004
					o	GAS	211322	111322.0		
Touring 535i, 540i excl.	(E39)	01.97 - 05.04			/	GAS	210184	110184.0	600240	516004
					o	GAS	211322	111322.0		

5 SERIES (E60) EXCL. M-TECHNIK

520i, 530i 530d 525i, 545i, 525d	(E60)	07.03 - 03.10			/	GAS	210200	110200.1	110200.2	600240	516004
		09.03 - 03.10			/	GAS	211035	111035.0			
535d 523i, 520d, 550i	(E60)	09.04 - 03.10			/	GAS	210200	110200.1	110200.2	600240	516004
		07.05 - 03.10			/	GAS	211035	111035.0			

5 SERIES TOURING (E61)

520i, 525i, 530i, 545i, 525d, 530d 535d	(E61)	06.04 - 12.10			/	GAS	210938	110938.1	110938.2	600240	516004
		09.04 - 12.10			/	GAS	211037	111037.0			
523i	(E61)	07.05 - 12.10			/	GAS	210938	110938.1	110938.2	600240	516004
					/	GAS	211037	111037.0			

5 SERIES (F10, F18) EXCL. M-TECHNIK

523i, 528i, 535i, 550i excl. xDrive 520d, 525d, 530d, 535d excl. xDrive	(F10, F18)	01.09 - 10.16			/	GAS	211222	111222.1	111222.2		516004
				excl.	o	GAS	212061	112061.0			516010

5 SERIES TOURING (F11)

excl.	(F11)	11.09 - 02.17			/	GAS	211222	111222.1	111222.2		516010
					o	GAS	212067	112067.0			

5 SERIES (G30, F90) EXCL. M-TECHNIK *NEW*

excl. ,	(G30, F90)	09.16 -			/	GAS	212160	112160.1	112160.2		516001
					/	GAS	212161	112161.0			516001

BMW (D)

5 SERIES TOURING (G31) EXCL. M-TECHNIK *NEW*

excl. ,	(G31)	03.17 -				GAS	212160	112160.1	112160.2			516001

6 SERIES (E24) EXCL. M-TECHNIK

	(E24)	04.76 - 06.78				GAS	210007	110007.0			516004
	(E24)	06.78 - 05.82				GAS	210016	110016.0			516004
excl.	(E24)	06.82 - 09.90				GAS	210012	110012.0			516004
				excl.							

6 SERIES (E63, E64) EXCL. M-TECHNIK

630i, 650i, 645Ci, 635d excl. 630i, 650i, 645Ci, 635d excl.	(E63, E64)	01.04 - 12.10 09.04 - 12.10				GAS	210200	110200.1	110200.2	600240	516004
				excl.							

6 SERIES (F12, F13)

640i, 650i, 640d, excl. , 4x4	(F12)	12.10 - 06.18				GAS	211222	111222.1	111222.2		
640i, 650i, 640d, excl. , 4x4	(F13)	07.11 - 10.17				GAS	211222	111222.1	111222.2		

7 SERIES (E23)

728, 728i, 730, 733i	(E23)	1977 - 09.79				GAS	210016	110016.0			516004
728i, 732i, 735i 745i	(E23)	09.79 - 09.81 07.79 - 08.86				GAS	210016	110016.0			516004
					0						
728i, 732i, 735i	(E23)	10.81 - 08.86				GAS	210016	110016.0			516004
				excl.							

7 SERIES (E32) EXCL. M-TECHNIK

730i, 735i, 735iL excl. ,	(E32)	09.86 - 02.88				GAS	210017	110017.0			516004
				excl.							
730i, 735i, 735iL excl. ,	(E32)	03.88 - 07.90				GAS	210018	110018.0			516004
				excl.							
730i, 735i, 735iL excl.	(E32)	08.90 - 07.94				GAS	210019	110019.0			516004
				excl.							

7 SERIES (E38) EXCL. M-TECHNIK

725tds, 728i, 730i, 740i 728iL, 730iL, 740iL, 750iL	(E38)	05.94 - 11.01 05.94 - 11.01				GAS	210940	110940.1	110940.2			516004
				excl.								

7 SERIES (E65, E66, E67) EXCL. M-TECHNIK

730i, 735i, 740i, 745i, 750i, 760i ind. Li excl. 730d, 730Ld excl.	(E65, E66)	11.01 - 12.09				GAS	210942	110942.1	110942.2			516004
				excl.								



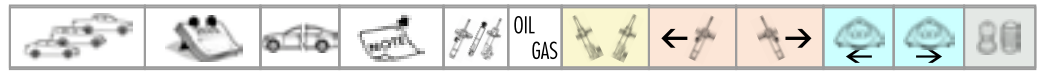

7 SERIES (F01, F02, F03, F04) EXCL. M-TECHNIK

730i, 740i, 750i, excl. , xDrive, Active Hybrid 760i, 730d, 740d excl. , xDrive, Active Hybrid	(F01, F02, F03, F04)	06.08 - 12.15									516004
				excl.							





BMW (D)





8 SERIES (E31) EXCL. M-TECHNIK

 excl. 	(E31)	04.90 - 12.99			/										516004
					o										











2500-3.3 (E3)

		10.68 - 04.77			/	GAS	210007	110007.0							516004
					o										







2000-3.2 Coupé (E9)

 2.5 CS, 3.0 CS  3.0 CSi		01.74 - 12.76			/	GAS	210007	110007.0							516004
		04.71 - 12.75			o										







X1 (E84)

 xDrive	(E84)	10.09 - 06.15				GAS	210944	110944.1	110944.2	600240					516004
				excl. 	+	GAS	212062	112062.0							
 sDrive	(E84)	10.09 - 06.15				GAS	210943	110943.1	110943.2	600240					516004
				excl. 	+	GAS	212062	112062.0							





X1 II (F48)

 sDrive, xDrive excl.  	(F48)	11.14 -				GAS	210949	110949.1	110949.2						516004
					o	GAS	212069	112069.0							







X2 (F39) *NEW*

 excl. xDrive,  	(F39)	11.17 -				GAS	210949	110949.1	110949.2						516004
					o	GAS	212069	112069.0							







X3 (E83)

 2.5i, 3.0i, 3.0d  2.0d	(E83)	01.04 - 12.11				GAS	210194	110194.1	110194.2	600240					516004
		10.04 - 12.11			o	GAS	211326	111326.0							







X3 II (F25)

 excl.  	(F25)	09.10 - 08.17				GAS	210947	110947.1	110947.2						516004
						GAS	211228	111228.0							







X3 III (G01, F97) *NEW*

 excl. M,  	(G01, F97)	08.17 -				GAS	212222	112222.1	112222.2						516006
						GAS	212223	112223.0							





X4 (F26)

 excl. xDrive,  	(F26)	04.14 - 03.18				GAS	210947	110947.1	110947.2						516004
						GAS	211228	111228.0							

X4 II (G02, F98) *NEW*

 excl. M,  	(G02, F98)	04.18 -				GAS	212222	112222.1	112222.2						516006
						GAS	212223	112223.0							





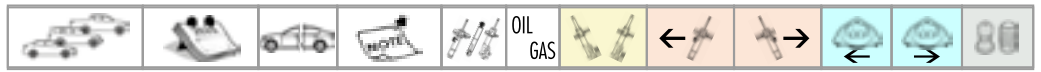

X5 (E53)

 3.0i, 4.4i, 3.0d, 4.6is excl. 	(E53)	05.00 - 12.06				GAS	210195	110195.1	110195.2						516004
					o	GAS	211327	111327.0							









BMW (D)







X5 II (E70)

 3.0 si, 3.0 d, 3.0 sd incl. xDrive, excl. M,  , 	(E70)	02.06 - 07.13				GAS	211226	111226.0			516010
						GAS	212063	112063.1	112063.2		







X5 III (F15, F85) *NEW*

 excl. 	(F15, F85)	08.13 - 07.18				GAS	212158	112158.0			516003
						GAS	212159	112159.1	112159.2		







X6 (E71, E72)

 35i, 50i, 30d, 35d incl. xDrive, excl. M,  ,  , Active Hybrid	(E71, E72)	05.08 - 06.14				GAS	211226	111226.0			
						GAS	212063	112063.1	112063.2		





X6 II (F16, F86) *NEW*

 excl. 	(F16, F86)	08.14 - 07.19				GAS	212158	112158.0			516003
						GAS	212159	112159.1	112159.2		

Z3 (E36)











 1.8, 1.9, 2.0, 2.2, 2.8, 3.0  2.8, 3.0 excl. 	(E36)	10.95 - 06.03				GAS	210181	110181.1	110181.2		516004
						GAS	211321	111321.0			

Z4 (E85)







 2.5i, 3.0i, 2.2i, 2.0i	(E85)	02.03 - 12.09				GAS	210196	110196.1	110196.2		516004
						GAS	211328	111328.0			

CHEVROLET (EU)











AVEO

	(T250, T255)	03.05 -				GAS	210931	110931.1	110931.2			516004
						GAS	212051	112051.0			516010	
	(T300)	03.11 -				GAS	212166	112166.1	112166.2			
						GAS	211704	111704.0	600781	600782	516010	





CAPTIVA

 excl. 	(C100, C140)	06.06 -				GAS	210869	110869.1	110869.2	600170		516004
						GAS	211706	111706.0			-	





CRUZE

	(J300, J305, J308)	05.09 - 04.12				GAS	210871	110871.1	110871.2			516004
						GAS	212003	112003.0			516010	
	(J300, J305, J308)	05.12 -				GAS	212206	112206.1	112206.2			516004
						GAS	212003	112003.0			516010	





KALOS

	(T200)	05.03 - 05.08				GAS	210931	110931.1	110931.2			516004
						GAS	212051	112051.0			516010	







LACETTI

	(J200)	01.05 -				GAS	210934	110934.1	110934.2			516004
						GAS	210935	110935.1	110935.2			516004





MATIZ

	(M220, M250)	03.05 -				GAS	210932	110932.1	110932.2			516004
						GAS	212052	112052.0			-	











ORLANDO

 incl.  16, 17 e 18 inch	(J309)	02.11 -				GAS	210871	110871.1	110871.2			516004
						GAS	212055	112055.0			516010	





NUBIRA

		03.05 - 12.09				GAS	210934	110934.1	110934.2			516004
		03.05 - 12.09				GAS	210935	110935.1	110935.2			516004

SPARK

		05.05 -				GAS	210932	110932.1	110932.2			516004
						GAS	212052	112052.0			516010	
	(M300)	03.10 -				GAS	212167	112167.1	112167.2			516004
						GAS	212056	112056.0			516010	



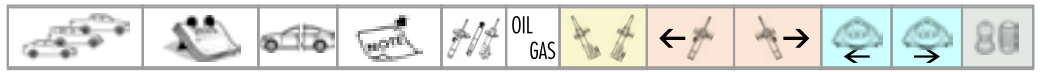

TACUMA MPV

		03.05 -				GAS	210936	110936.1	110936.2			516004
						GAS	212054	112054.0			-	









CHRYSLER (USA)











300 C

	(LX, LE)	09.04 - 11.12				GAS	211044	111044.1	111044.2			
		09.04 - 12.10				GAS	211364	111364.0				







GRAND VOYAGER

 excl. 	(RT)	10.07 -				GAS	210450	110450.0			516004
						GAS	211505	111505.0			-











NEON

 excl. 	(PL)	10.93 - 08.99				GAS	210230	110230.0			516004
						GAS	210231	110231.0			516004
		08.99 - 12.06				GAS	210236	110236.0			516004
						GAS	210237	110237.1 110237.2			516004











PT CRUISER

 excl. 		06.00 - 12.10				GAS	210234	110234.0			516004
						GAS	211363	111363.0			-







STRATUS/CIRRUS

	(JA)	12.95 - 04.01				GAS	210233	110233.0			516004
						GAS	211043	111043.0			
	(JX)	04.96 - 04.01				GAS	210233	110233.0			516004
						GAS	211043	111043.0			





VOYAGER I / II

	(AS)	08.84 - 12.85									516004
						GAS	211362	111362.0			-
 4X2, 4X4 incl. Grand Voyager, Grand Caravan	(ES)	01.86 - 01.95				GAS	210229	110229.0			516004
						GAS	211362	111362.0			-

VOYAGER III





 excl. 4X4,  incl. Grand Voyager, Grand Caravan	(GS)	02.95 - 03.01		10A		GAS	210232	110232.0			516004
						GAS	211362	111362.0			-

VOYAGER IV





 excl. 4X4 incl. Grand Voyager, Grand Caravan	(RG)	02.00 - 12.08		10B		GAS	210235	110235.0	600250		516004
						GAS	211362	111362.0			-

CITROËN (F)







2 CV

2 CV, 2 CV 4, 2 CV 6 AK 250		01.65 - 07.90			⊘	OIL	201335	101335.0			-
		01.65 - 07.90			⊘	OIL	201336	101336.0			-
AK 400, AK 350		01.63 - 06.76			⊘	OIL	201335	101335.0			-
					⊘						



AMI

Ami 6		01.61 - 05.63			⊘	OIL	201335	101335.0			-
					⊘	OIL	201336	101336.0			-
Ami 6 Ami 8 excl. Super		06.63 - 07.69 07.69 - 12.77			⊘	OIL	201335	101335.0			-
					⊘						







AX

1.0, 1.1	(ZA)	07.86 - 12.98		/	OIL	200022	100022.0	600120	516004
				/	GAS	210022	110022.0		
				⊘	OIL	201340	101340.0		-
				⊘	GAS	211340	111340.0		-
1.3 Sport	(ZA)	04.87 - 12.88		/	OIL	200022	100022.0	600120	516004
				/	GAS	210022	110022.0		
				⊘	OIL	201340	101340.0		-
				⊘	GAS	211340	111340.0		-
1.4 excl. GTi, 4X4 1.4 D, 1.5 D excl. 4X4	(ZA)	07.86 - 12.98		/	OIL	200022	100022.0	600120	516004
				/	GAS	210022	110022.0		
		09.88 - 12.98		⊘	OIL	201340	101340.0		-
				⊘	GAS	211340	111340.0		-
1.4 GTi 1.4 4X4	(ZA)	05.91 - 12.96 08.91 - 12.96		/	GAS	210022	110022.0	600120	516004
				⊘	GAS	211340	111340.0		

AXEL/OLTCIT

		10.81 - 03.91			⊘	OIL	201341	101341.0			516004
					⊘	OIL	201342	101342.0			-

BERLINGO

excl. 4X4	(MF)	07.96 - 11.02			⚡	GAS	210210	110210.1	110210.2	600110	516004	
					⊘	GAS	211713	111713.0			-	
excl. 4X4	(G)	12.02 - 12.11			⚡	GAS	210588	110588.1	110588.2	600101	600102	516004
					⊘	GAS	211713	111713.0			-	
	(B9)	04.08 -			⚡	GAS	210224	110224.1	110224.2	600090	516004	
					⊘	GAS	211357	111357.0			-	
	(ER, EC)	06.18 -			⚡	GAS	212224	112224.0			516004	
					⊘	GAS	212225	112225.0			-	

C1

















1.0i, 1.4d	(PM, PN)	07.05 - 09.14			⚡	GAS	210223	110223.1	110223.2			516003
					⊘	GAS	211356	111356.0			516010	

C1 II























1.0 Vti, 1.2 Vti	(PA, PS)	04.14 -			⚡	GAS	210223	110223.1	110223.2			516004
					⊘	GAS	211356	111356.0			516010	

CITROËN (F)











C2

 1.1, 1.4 excl. 	(JM)	09.03 - 12.09			GAS	210221	110221.1	110221.2			516004
					GAS	211353	111353.0				-
 1.4 Hdi excl. 	(JM)	07.03 - 12.09			GAS	210212	110212.1	110212.2	600230		516004
					GAS	211353	111353.0				-
 1.6 16V	(JM)	07.03 - 12.09			GAS	210212	110212.1	110212.2	600230		516004
					GAS	211353	111353.0				-















C3 I

 1.1, 1.4 excl. 	(FC, FN)	02.02 -			GAS	210212	110212.1	110212.2	600230		516004
					GAS	211353	111353.0				-
 1.6, 1.4 Hdi excl. 	(FC, FN)	02.02 -			GAS	210212	110212.1	110212.2	600230		516004
					GAS	211353	111353.0				-
	(FC, FN)	02.02 -			GAS	210212	110212.1	110212.2	600230		516004
					GAS	211353	111353.0				-
 Pluriel	(HB)	05.03 -			GAS	210221	110221.1	110221.2			516004
					GAS	211353	111353.0				-





C3 II

	(SC)	11.09 -		11A		GAS	210226	110226.1	110226.2	600235		516004
					GAS	211359	111359.0				-	
	(SC)	11.09 -		11B		GAS	210227	110227.1	110227.2	600235		516004
					GAS	211359	111359.0				-	





C3 III

 Ø47	(SX)	07.16 -		11B		GAS	212139	112139.1	112139.2			
					GAS	212141	112141.0				-	
 Ø51	(SX)	07.16 -		11A		GAS	212140	112140.1	112140.2			
					GAS	212141	112141.0				-	
 Ø51	(SX)	07.16 -		11A		GAS	212265	MG6618	MG6619			
					GAS	212141	112141.0				-	











C3 PICASSO

	(SH)	02.09 -				GAS	210593	110593.1	110593.2			516004
					GAS	211732	111732.0				-	





C3 AIRCROSS II *NEW*

	(2R, 2C)	06.17 -										
					GAS	211739	111739.0				-	

C4

 excl. 2.0 HDi (136 HP), 2.0 16V (177 HP)	(LC)	11.04 - 07.11				GAS	210589	110589.1	110589.2	600090		516004
					GAS	211729	111729.0				-	
 ,  2.0 HDi (136 HP), 2.0 16V (177 HP)	(LC)	11.04 - 07.11				GAS	210589	110589.1	110589.2	600090		516004
					GAS	211355	111355.0				-	

C4 II

	(B7)	11.09 -				GAS	210228	110228.1	110228.2			516004
					GAS	211360	111360.0				-	

CITROËN (F)

C4 AIRCROSS

		04.12 -				GAS	210538	110538.1	110538.2			516004
								GAS	211121	111121.0		

C4 CACTUS

		09.14 -		11B		GAS	210227	110227.1	110227.2	600235		516004
							GAS	211361	111361.0			-
		09.14 -		11A		GAS	210226	110226.1	110226.2	600235		516004
							GAS	211361	111361.0			-

C4 PICASSO/GRAND PICASSO

Picasso	(UD)	02.07 - 08.13				GAS	210224	110224.1	110224.2	600090		516004
Grand Picasso	(UA)	10.06 - 12.13				GAS	211357	111357.0			-	

C4 PICASSO II/GRAND PICASSO II

Picasso	(DA, DE)	02.13 -				GAS	210603	110603.0				516004
Grand Picasso							GAS	211740	111740.0			516010

C4 SPACETOURER / GRAND C4 SPACETOURER *NEW*

	(3D, 3A, 3E)	04.18 -				GAS	210603	110603.0				516004
							GAS	211740	111740.0			516010

C5 III

, Excl. ♀	(RD)	02.08 -				GAS	211138	111138.0				
							GAS	211139	111139.0			

C5 AIRCROSS *NEW*

		11.18 -				GAS	212212	112212.0				516004
							GAS	211740	111740.0			-

C8

	(EA, EB)	07.02 -				GAS	210447	110447.1	110447.2	600741	600742	516004
							GAS	211289	111289.0			-

C15

1.0, 1.1, 1.4 (XW7, VDPA > Ch. 4195) excl. 4X4	(VD)	10.84 - 05.88				OIL	200202	100202.0				516004
							OIL	201042	101042.0			
1.0, 1.1, 1.4 (TU, VDPY Ch. 4196 >) excl. 4X4	(VD)	05.88 - 07.96				OIL	200203	100203.0				516004
							OIL	201042	101042.0			
1.3 (G1A, VDPV, Ch. 3887 > 4237) excl. 4X4	(VD)	07.87 - 06.88				OIL	200203	100203.0				516004
							OIL	201042	101042.0			
1.8 D, 1.9 D 475 Kg, 600 Kg, excl. 4X4	(VD)	07.86 -										
1.8 D, 1.9 D 760 Kg excl. 4X4	(VD)	04.87 - 08.00				OIL	200203	100203.0				516004
							OIL	201042	101042.0			

C25

,	(280, 290)	07.81 - 12.85				OIL	200206	100206.0				516004
				14A			OIL	201347	101347.0			-

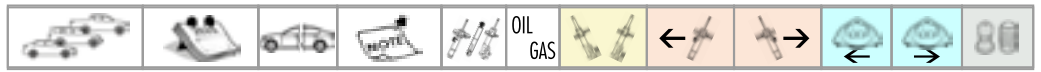

CITROËN (F)

	(280, 290)	07.81 - 12.85		14B		OIL	200206	100206.0			516004
						OIL	201348	101348.0			-
excl. 1800 Kg	(280, 290)	01.86 - 03.94		14A		OIL	200207	100207.0			516004
						OIL	201347	101347.0			-
1800 Kg	(280, 290)	01.86 - 03.94		14C		OIL	200136	100136.0			516004
						OIL	201278	101278.0			-
	(280, 290)	01.86 - 03.94		14B		OIL	200207	100207.0			516004
						OIL	201348	101348.0			-

C32, C35

		11.73 - 01.94				OIL	201345	101345.0			-
						OIL	201346	101346.0			-

C-CROSSER

2.4, 2.2 Hdi	(VU, VV)	02.07 -				GAS	210225	110225.1	110225.2			516004
						GAS	211358	111358.0				

C-ELYSEE

	(DD)	11.12 -		ø47		GAS	210973	110973.1	110973.2			516004
				ø51		GAS	212211	112211.1	112211.2			516004
					GAS	212090	112090.0				-	

DYANE

excl. Acadyane		08.67 - 10.84				OIL	201335	101335.0			-
						OIL	201336	101336.0			-

DS3

		11.09 - 07.15		11A		GAS	210226	110226.1	110226.2	600235	516004
						GAS	211359	111359.0			-
		11.09 - 07.15		11B		GAS	210227	110227.1	110227.2	600235	516004
						GAS	211359	111359.0			-

DS4

		04.11 - 07.15				GAS	210228	110228.1	110228.2			516004
						GAS	211360	111360.0			516010	

DS5

		11.11 - 07.15				GAS	210974	110974.1	110974.2			516004
						GAS	211357	111357.0			-	

EVASION/SYNERGIE









































(> Ch. 7609)	(22, U6)	03.94 - 12.97		18B		GAS	210270	110270.0	600741	600742	516004
						GAS	211401	111401.0			-

JUMPER/RELAY





























1000 Kg, 1400 Kg	(230L)	02.94 - 04.02		15B		OIL	200265	100265.0	600071	600072	516007
						GAS	210265	110265.0			
				14C		OIL	201398	101398.0			-
						GAS	211398	111398.0			-











CITROËN (F)

1800 Kg	(230L)	02.94 - 04.02		15B		OIL	200280	100280.0	600071	600072	516007
						GAS	210280	110280.0			
				14E		OIL	201405	101405.0			-
						GAS	211405	111405.0			-
	(230P)	02.94 - 04.02		15B		OIL	200265	100265.0	600071	600072	516007
						GAS	210265	110265.0			
											-
										-	
1000 Kg, 1400 Kg	(244)	02.02 -		15B		OIL	200265	100265.0	600071	600072	516007
						GAS	210265	110265.0			
				14C		OIL	201398	101398.0			-
						GAS	211398	111398.0			-
1800 Kg	(244)	02.02 -		15B		OIL	200280	100280.0	600071	600072	516007
						GAS	210280	110280.0			
				14E		OIL	201405	101405.0			-
						GAS	211405	111405.0			-
1000Kg 1400Kg	(250)	04.06 -		15C		GAS	210881	110881.0	600651	600652	516007
						14F		GAS	211296	111296.0	
1400Kg 2000Kg	(250)	04.06 -		15C		GAS	210882	110882.0	600651	600652	516007
						14G		GAS	211301	111301.0	
1000Kg 1400Kg REINFORCED	(250)	04.06 -		15C		GAS	210159	110159.0	600651	600652	516007
						14F		GAS	211296	111296.0	
1400Kg 2000Kg REINFORCED	(250)	04.06 -		15C		GAS	210167	110167.0	600651	600652	516007
						14G		GAS	211301	111301.0	

JUMPY/DISPATCH

 (> Ch. 7609)	(U6U)	06.94 - 09.97		18A		GAS	210270	110270.0	600741	600742	516004
						GAS	211401	111401.0			-
 (Ch. 7610 > 9793)	(U6U)	09.97 - 10.03		18B		GAS	210270	110270.0	600741	600742	516004
						GAS	211351	111351.0			-
 (Ch. 9794 > 10408)		10.03 - 05.04		18B		GAS	210166	110166.1 110166.2	600741	600742	516004
						GAS	211351	111351.0			-
 (Ch. 10409 >)		05.04 -		18B		GAS	210270	110270.0	600741	600742	516004
						GAS	211351	111351.0			-
 1.6D, 2.0 D	(272)	01.07 -		18C		GAS	210169	110169.1 110169.2	600741	600742	516004
						GAS	211303	111303.0			-
 1.6D, 2.0 D H.D.	(272)	01.07 -		18D		GAS	210170	110170.1 110170.2	600741	600742	516004
						GAS	211304	111304.0			-
 *NEW*	(V)	04.16 -				GAS	212164	112164.0			516004
						GAS	212165	112165.0			-

LN/LNA

LN 0.6		11.76 - 10.86				OIL	200023	100023.0			516004
						OIL	201038	101038.0			
LN 0.6		05.77 - 12.80				OIL	200023	100023.0			516004
						OIL	201039	101039.0			
LNA 0.6, 1.1		11.78 - 10.86				OIL	200202	100202.0			516004
						OIL	201039	101039.0			

CITROËN (F)

MEHARI

excl. 4X4, F.A.F.		05.68 - 10.87			∅	OIL	201335	101335.0			-
					∅	OIL	201336	101336.0			-

NEMO

1.2 HDi, 1.4, 1.4 HDi N.D. Finestrato	(AA)	04.09 -			∅	GAS	210173	110173.1	110173.2	600541	600542	516004
					∅	GAS	211305	111305.0				
1.2 HDi, 1.4, 1.4 HDi H.D. Cassonato	(AA)	02.08 -			∅	GAS	210173	110173.1	110173.2	600541	600542	516004
					∅	GAS	212012	112012.0				

SAXO

1.0, 1.1	(S0, S1)	05.96 - 04.04			/	OIL	200022	100022.0		600120		516004	
					/	GAS	210022	110022.0					
					∅	OIL	201340	101340.0					-
					∅	GAS	211340	111340.0					-
1.4 1.5 D	(S0, S1)	05.96 - 04.04 05.96 - 04.04			/	OIL	200022	100022.0		600120		516004	
					/	GAS	210022	110022.0					
					∅	OIL	201340	101340.0					-
					∅	GAS	211340	111340.0					-
1.6, 1.6 16V	(S0, S1)	05.96 - 04.04			/	OIL	200022	100022.0		600120		516004	
					/	GAS	210022	110022.0					
					∅	OIL	201340	101340.0					-
					∅	GAS	211340	111340.0					-

SPACETOURER

excl. 4x4	(V)	04.16 -			∅	GAS	212164	112164.0				516004
					∅	GAS	212165	112165.0				

VISA

































excl. Chrono, GT, GTI, 1.7 D		09.78 - 03.91			∅	OIL	200202	100202.0				516004
					∅	OIL	201040	101040.0				
Chrono, GT, GT Tonic		09.78 - 03.91			∅	OIL	200202	100202.0				516004
					∅	OIL	201041	101041.0				
1.6 GTI		01.85 - 03.91			∅							516004
					∅	OIL	201041	101041.0				
1.7 D		06.84 - 03.91			∅	OIL	200575	100575.0				516004
					∅	OIL	201040	101040.0				

XSARA





1.1, 1.4, 1.6, 1.8 excl. VTS 1.9 D, 1.9 TD, 2.0 Hdi excl. VTS	(N1, N0)	04.97 - 09.00 04.97 - 09.00			∅	GAS	210210	110210.1	110210.2	600110		516004
				N.D.	∅	OIL	201344	101344.0				-
					∅	GAS	211709	111709.0				
VTS	(N0)	02.98 - 09.00			∅	GAS	210210	110210.1	110210.2	600110		516004
					∅	GAS	211708	111708.0				
1.4 excl.	(N1, N0)	09.00 - 04.05			∅	GAS	210215	110215.1	110215.2	600110		516004
				N.D.	∅	OIL	201344	101344.0				-
					∅	GAS	211709	111709.0				
				H.D.	∅	GAS	211708	111708.0				-



























CITROËN (F)

 1.6, 2.0, 2.0 VTS, 1.9 D, 2.0 Hdi excl. 	(N1, N0)	09.00 - 04.05				GAS	210217	110217.1	110217.2	600110	516004
				N.D.		OIL	201344	101344.0			-
		09.00 - 04.05		N.D.		GAS	211709	111709.0			-
				H.D.		GAS	211708	111708.0			-
	(N2)	10.97 - 09.00				GAS	210210	110210.1	110210.2	600110	516004
						GAS	211708	111708.0			-
 1.4 excl. 	(N2)	09.00 - 08.05				GAS	210215	110215.1	110215.2	600110	516004
				N.D.		OIL	201344	101344.0			-
		09.00 - 08.05		N.D.		GAS	211709	111709.0			-
				H.D.		GAS	211708	111708.0			-
 1.6, 2.0, 2.0 VTS, 1.9 D, 2.0 Hdi excl. 	(N2)	09.00 - 08.05				GAS	210217	110217.1	110217.2	600110	516004
				N.D.		OIL	201344	101344.0			-
		09.00 - 08.05		N.D.		GAS	211709	111709.0			-
				H.D.		GAS	211708	111708.0			-
	(N1, N0, N2)	09.00 - 08.05				GAS	210216	110216.1	110216.2		516004
						GAS	211350	111350.0			-

XSARA PICASSO

	(N68)	12.99 - 06.12				GAS	210209	110209.1	110209.2	600110	516004
						GAS	211352	111352.0			-



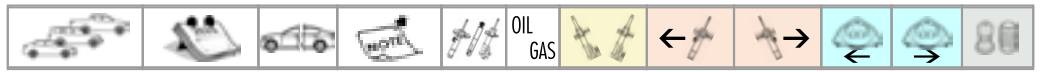

ZX

 1.1  1.4	(N2)	03.91 - 06.97				GAS	212091	112091.1	112091.2	600110	516004
						OIL	201344	101344.0			-
 1.6, 1.8  1.8 D, 1.9 D, 1.9 TD excl. Volcane	(N2)	03.91 - 06.97				GAS	210210	110210.1	110210.2	600110	516004
				N.D.		OIL	201344	101344.0			-
				N.D.		GAS	211709	111709.0			-
				H.D.		GAS	211708	111708.0			-
 1.9, 2.0 > Ch. 5683	(N2)	03.91 - 03.92				GAS	210205	110205.1	110205.2	600110	516004
						GAS	211708	111708.0			-
 1.9, 2.0 Volcane Ch. 5684 >  2.0 16V	(N2)	06.91 - 06.97				GAS	210210	110210.1	110210.2	600110	516004
						GAS	211708	111708.0			-
	(N2)	10.93 - 10.97				GAS	210210	110210.1	110210.2	600110	516004
						GAS	211349	111349.0			-







DACIA (R)











1000 SERIES

1210, 1300, 1310, 1410		12.72 - 05.83			OIL	201143	101143.0			
					OIL	201756	101756.0			





DOKKER

	(KE)	11.12 -			GAS	210960	110960.0			516004
					GAS	212077	112077.0			





















DUSTER

	(HS)	04.10 - 01.18			GAS	210956	110956.0			516004
					GAS	212075	112075.0			516011
	(HS)	06.10 - 01.18			GAS	210956	110956.0			516004
					GAS	210957	110957.0			516004











LODGY

	(JS)	03.12 -			GAS	210961	110961.0			516004
					GAS	212078	112078.0			-





LOGAN

	(LS)	09.04 -			GAS	210951	110951.0			516004
					GAS	212070	112070.0			516011
	(KS)	02.07 -			GAS	210952	110952.0			516004
					GAS	212071	112071.0			516011
	(FS)	03.09 -			GAS	210953	110953.0			516004
					GAS	212072	112072.0			516011
	(US)	03.08 -			GAS	210954	110954.0			516004
					GAS	212073	112073.0			516011





LOGAN II

		10.12 -			GAS	210958	110958.0			516004
					GAS	212076	112076.0			516011
		02.13 -			GAS	210958	110958.0			516004
										

SANDERO

		06.08 -			GAS	210955	110955.0			516004
					GAS	212074	112074.0			516010

SANDERO II

		10.12 -			GAS	210959	110959.0			516004
					GAS	212076	112076.0			516011

DAEWOO (KO) - CHEVROLET (EU)

AVEO *NEW*

	(T300)	03.11 -				GAS	212166	112166.1	112166.2			516004
						GAS	211704	111704.0	600781	600782	516010	

CAPTIVA *NEW*

excl. 1*	(C100, C140)	06.06 -				GAS	210869	110869.1	110869.2			516006
						GAS	211706	111706.0			-	

ESPERO

	(KLEJ)	10.91 - 09.99				GAS	210046	110046.0			516004
						OIL	201662	101662.0			516010

KALOS

	(KLAS)	09.02 -				GAS	210931	110931.1	110931.2			516004
						GAS	212051	112051.0			516010	

LACETTI

	(KLAN)	02.04 -				GAS	210934	110934.1	110934.2			516004
						GAS	210935	110935.1	110935.2			516004

LANOS

	(KLAT)	02.97 -				GAS	210046	110046.0			516004
						GAS	201662	101662.0			516010

LEGANZA

	(KLAV)	06.97 - 04.04				GAS	210929	110929.1	110929.2			
						GAS	210930	110930.1	110930.2			

MATIZ

incl. ABS	(M100, M150)	09.98 -				OIL	200924	100924.1	100924.2	600140		516004
						GAS	210924	110924.1	110924.2			
						OIL	202049	102049.0			-	
						GAS	212049	112049.0			-	
	(M200, M250)	03.05 -				GAS	210932	110932.1	110932.2			516004
						GAS	212052	112052.0			-	

MATIZ/SPARK

NEW	(M300)	03.10 -				GAS	212167	112167.1	112167.2			516004
						GAS	212056	112056.0			516010	

NEXIA/CIELO







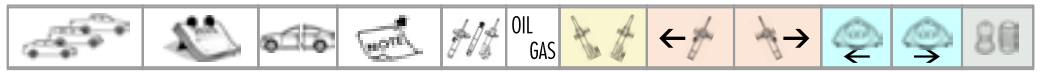

	(KLETN)	01.95 - 08.97				GAS	210046	110046.0			516004
						GAS	201662	101662.0			516010

NUBIRA





incl. ABS	(KLAJ)	05.97 - 07.97				GAS	210926	110926.1	110926.2			516004
						GAS	210927	110927.1	110927.2			516004
incl. ABS	(KLAJ)	08.97 - 05.99				GAS	210928	110928.1	110928.2			516004
						GAS	210927	110927.1	110927.2			516004







DAEWOO (KO) - CHEVROLET (EU)

incl. ABS	(KLAJ)	06.99 - 07.03				GAS	210928	110928.1	110928.2			516004
						GAS	210927	110927.1	110927.2			516004
	(KLAN)	07.03 - 12.09				GAS	210934	110934.1	110934.2			516004
						GAS	210935	110935.1	110935.2			516004





TACUMA/REZZO

incl. ABS	(U100)	09.00 -				GAS	210933	110933.1	110933.2			516004
						GAS	212053	112053.0				-

TICO





	(KLY3)	02.95 - 12.00				GAS	210925	110925.1	110925.2			516004
						GAS	212050	112050.0				-

TRAX















NEW		12.12				GAS	210876	110876.1	110876.2			516006
						GAS	212009	112009.0				516010

DAIHATSU (J)







FEROZA/SPORTRAK 4X4

F 300 series excl. F310, †	(F300)	10.88 - 12.97			⊖	GAS	211365	111365.0			
					⊖	GAS	211366	111366.0			
F 310 serie excl. †	(F310)	05.92 - 12.97			⊖	GAS	211365	111365.0			
					†						



FOURTRAK/ROCKY/TAFT 4X4

	(F10, F20, F50, F60)	1974 - 1984			⊖	GAS	211367	111367.0			-
					⊖	OIL	201368	101368.0			-
	(F25, F55, F65)	1979 - 1984			⊖	GAS	211367	111367.0			-
					♀	OIL	201634	101634.0			
	(F70, F75, F80, F85)	1984 - 04.93			⊖	GAS	211366	111366.0			
					⊖	GAS	211366	111366.0			
	(F77, F87)	1984 - 04.93			⊖	GAS	211366	111366.0			
					♀	OIL	201634	101634.0			
	(F73, F78, F98)	05.93 -			⊖	GAS	211369	111369.0			
					⊖	GAS	211370	111370.0			









TERIOS

	(J1)	10.97 - 05.00			↘	GAS	210238	110238.1	110238.2		516004
					⊖	GAS	211371	111371.0			-
	(J1)	05.00 - 10.05			↘	GAS	210238	110238.1	110238.2		516004
					⊖	GAS	211373	111373.0			-

TERIOS II







	(J2)	05.06 - 10.08			↘	GAS	210239	110239.0			516004		
				excl. 1.5 WT-i RWD	(J2)	05.06 - 10.08	GPL	↘	GAS	212214	112214.0	*NEW*	516004
									⊖	GAS	211374	111374.0	

WIDE CAB

	850-1000	(S65V)	04.81 - 11.83			↘	OIL	201312	101312.0		
						⊖	GAS	211312	111312.0		
	(S70, S75)	01.83 -				↘	OIL	201312	101312.0		
						⊖	GAS	211367	111367.0		
	4X4	(S76)	05.84 -			↘					
						⊖	GAS	211367	111367.0		

DODGE (USA)



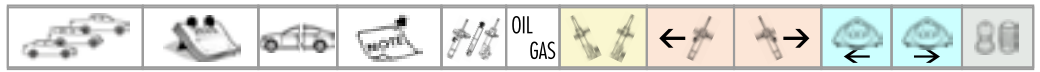

FREEMONT

	excl. 4x4	(345)	08.11 -			↘	GAS	210880	110880.1	110880.2		516004
						↘	GAS	211207	111207.0			
	4x4	(345)	08.11 -			↘	GAS	212138	112138.1	112138.2		516004
						↘	GAS	211207	111207.0			













DR (I)











CITYCROSS

 1.3, 1.3 GPL, 1.3 METANO		08.13 - 12.16				GAS	210967	110967.0			516004
						GAS	212085	112085.0			516010











DR ZERO

 1.0		06.15 -				GAS	210967	110967.0			516004
					44A		GAS	212083	112083.0		
 1.0 - vers. accorciata		06.15 -				GAS					
					44B		GAS	212130	112130.0		





DR 1

 1.1. 1.3		03.10 - 12.14				GAS	210967	110967.0			516004
					44A		GAS	212083	112083.0		
 1.1. 1.3 - vers. accorciata		03.10 - 12.14				GAS					
					44B		GAS	212130	112130.0		

DR 2

 1.3		09.10 - 12.14				GAS	210967	110967.0			516004
					44A		GAS	212083	112083.0		
 1.3 - vers. accorciata		09.10 - 12.14				GAS					
					44B		GAS	212130	112130.0		

DR 5

 1.6, 1.8, 2.0, 1.9D		01.07 -				GAS	210968	110968.1	110968.2		
							GAS	212084	112084.0		

FIAT (I)

124

S, T	(124)	02.66 - 03.75			⊖	OIL	201375	101375.0			
					⊖	OIL	201376	101376.0			
Familiare	(124)	04.67 - 03.75			⊖	OIL	201375	101375.0			
					⊖	OIL	201377	101377.0			
1800 Rally Abarth	(124)	09.72 - 07.75			⊖	GAS	211297	111297.0			
					⊖	GAS	210160	110160.0			

124 SPIDER II

excl.	(348)	03.16 -			⊖	GAS	211208	111208.0			
					⊖	GAS	211209	111209.0			
Abarth	(348)	03.16 -			⊖						
					⊖						

125

1.6, 1.6 Special	(125)	07.67 - 03.74			⊖	OIL	201378	101378.0			516004
					⊖	OIL	201379	101379.0			516010

126

excl. 126 Bis	(126)	09.72 - 08.87			+	OIL	201380	101380.0			
					+	OIL	201381	101381.0			
Bis	(126)	07.87 - 09.00			+	OIL	201380	101380.0			
					⊖	OIL	201400	101400.0			

127

0.9, 1.0 excl. Panorama e Diesel	(127)	06.71 - 12.86			⊖	OIL	200240	100240.0			516004
			1.1 Sport, 1.3 Sport			⊖	OIL	200134	100134.0		
Panorama	(127)	01.77 - 12.86			⊖	OIL	200240	100240.0			516004
					⊖	OIL	200242	100242.0			516004
Diesel	(127)	01.82 - 12.84			⊖	OIL	200241	100241.0			516004
					⊖	OIL	200242	100242.0			516004

128







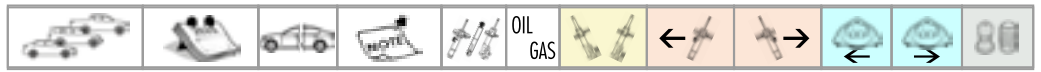











incl. Familiare e coupè 3P	(128)	03.69 - 12.84			⊖	OIL	200243	100243.0			516004
					⊖	OIL	200244	100244.0			516004

131





excl. Diesel > Ch. 4214186	(131)	10.74 - 02.78		12A	⊖	OIL	200245	100245.0			516004
			S			⊖	OIL	201376	101376.0		
excl. Diesel Ch. 4214186 >	(131)	03.78 - 02.81		12B	⊖	OIL	200246	100246.0			516004
			Racing			⊖	OIL	201376	101376.0		
excl. Diesel	(131)	03.81 - 12.83		12C	⊖	OIL	200247	100247.0			516004
					⊖	OIL	201376	101376.0			
Diesel > Ch. 1012810	(131)	03.78 - 09.79		12D	⊖	OIL	200248	100248.0			516004
					⊖	OIL	201376	101376.0			
Diesel Ch. 1012811 >	(131)	10.79 - 05.84		12E	⊖	OIL	200249	100249.0			516004
					⊖	OIL	201376	101376.0			
excl. Diesel > Ch. 4214186	(131)	10.74 - 02.78		12A	⊖	OIL	200245	100245.0			516004
					⊖	OIL	201383	101383.0			-













FIAT (I)

 excl. Diesel Ch. 4214186 >	(131)	03.78 - 02.81		12B		OIL	200246	100246.0			516004
							OIL	201383	101383.0		
 excl. Diesel	(131)	03.81 - 12.83		12C		OIL	200247	100247.0			516004
							OIL	201383	101383.0		
 Diesel	(131)	10.81 - 05.84		12E		OIL	200249	100249.0			516004
							OIL	201383	101383.0		
2.0 Abarth Rally	(131)	01.76 - 07.80		12F		GAS	210161	110161.0			516004
							GAS	210162	110162.0		





132

	(132)	04.72 - 12.82				OIL	201378	101378.0			
							OIL	201384	101384.0		





147

 (> Ch. 359244)		10.76 - 12.95				OIL	200241	100241.0			
							OIL	200134	100134.0		
 (Ch. 359245 >)		10.76 - 12.95				OIL	200241	100241.0			
							OIL	200242	100242.0		





238

	(238)	09.66 - 06.82				OIL	201395	101395.0			-
							OIL	201396	101396.0		











242

	(242)	10.75 - 07.82				OIL	201345	101345.0			-
							OIL	201346	101346.0		











500

 0.5, 0.6		01.57 - 01.76				OIL	201380	101380.0			
							OIL	201381	101381.0		











500 II

 	(312)	07.07 -				GAS	210168	110168.1	110168.2	600130	516004
							GAS	211302	111302.0		
 Abarth	(312)	08.08 -				GAS	212151	112151.1	112151.2		516004
							GAS	212152	112152.0		

500 L

	(351, 352)	09.12 -				GAS	210886	110886.1	110886.2		516004
							GAS	212015	112015.0	600781	600782
 Living, 7 Posti	(351, 352)	09.12 -				GAS	210886	110886.1	110886.2		516004
							GAS	212019	112019.0		

500 X

 excl. 4WD	(334)	09.14 -		13A		GAS	210888	110888.1	110888.2	600840	516004
				13A		GAS	210889	110889.1	110889.2	600851	600852
 4WD	(334)	09.14 -		13B		GAS	210890	110890.1	110890.2	600840	516004
				13B		GAS	210891	110891.1	110891.2	600851	600852

FIAT (I)

600

↻ 600, 600 D		03.55 - 02.71			+	OIL	201385	101385.0			
					+	OIL	201386	101386.0			

850

↻ 850, 850 L, 850 Special		07.64 - 12.72				OIL	201387	101387.0			
						OIL	201388	101388.0			

ARGENTA

	(132A)	05.77 - 03.87			+	OIL	201378	101378.0			
					+	OIL	201384	101384.0			

BARCETTA

↻	(183)	03.95 - 05.05			+	GAS	210272	110272.0			516004
					+	GAS	211403	111403.0			-

BRAVA/BRAVO

↻ 1.4, 1.6 (> Ch. 4085697)	(182)	10.95 - 01.96			+	GAS	210258	110258.0	600690		516004
					+	GAS	211404	111404.0			-
↻ 1.4, 1.6 (Ch. 4085697 >) ↻ 1.2, 1.9 D	(182)	01.96 - 10.01 10.95 - 10.01			+	GAS	210273	110273.0	600690		516004
					+	GAS	211404	111404.0			-
↻ 1.8 ↻ 1.9 TD, 1.9 JTD	(182)	10.95 - 10.01 03.96 - 10.01			+	GAS	210274	110274.0	600690		516004
					+	GAS	211404	111404.0			-
↻ 2.0 20V excl. Sport Pack	(182)	10.95 - 10.01			+	GAS	210275	110275.0	600751	600752	516004
					+	GAS	211404	111404.0			-

BRAVO II

↻ excl 1.9 150CV, 2.0 D Multijet	(198)	11.06 - 12.14		13A	+	GAS	210163	110163.0	600560		516004
					+	GAS	211298	111298.0			516010
↻ 1.9 150CV, 2.0 D Multijet	(198)	04.07 - 12.14		13B	+	GAS	210175	110175.0	600560		516004
					+	GAS	211298	111298.0			516010

CAMPAGNOLA

↻ AR-59		06.74 - 10.89			+	OIL	202013	102013.0			-
					+	OIL	202014	102014.0			-
↻ 1107		06.74 - 10.89			+	OIL	200884	100884.0			
				2 PER LATO	+	OIL	200885	100885.1 100885.2			

CINQUECENTO

↻ 0.7, 0.8	(170)	07.91 - 01.98			+	OIL	200140	100140.0	600580		516004
					+	GAS	210140	110140.0			
					+	OIL	201389	101389.0			-
↻ 1.1 Sporting	(170)	10.94 - 01.98			+	GAS	210283	110283.0	600580		
					+	OIL	201389	101389.0			-

COUPÈ

↻ 1.8 16V, 2.0 16V, 2.0 20V	(175)	11.93 - 08.00			+	GAS	210271	110271.0			516004
					+	GAS	211402	111402.0			-

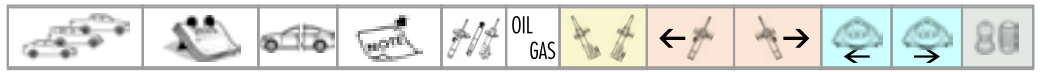

FIAT (I)

2.0 Turbo 16V, 2.0 Turbo 20V	(175)	11.93 - 08.00				GAS	210276	110276.0			516004
						GAS	211402	111402.0			-

CROMA

excl. 2.0 Turbo H	(154)	12.85 - 09.86				GAS	210251	110251.0			516004
						GAS	210250	110250.0			516004
excl. 2.0 Turbo H	(154)	10.86 - 12.96				GAS	210251	110251.0			516004
				excl.		GAS	210106	110106.0			516004
excl. 2.0 Turbo	(154)	12.85 - 09.86				GAS	210251	110251.0			516004
						GAS	210250	110250.0			516004
excl. 2.0 Turbo	(154)	10.86 - 12.96				GAS	210251	110251.0			516004
				excl.		GAS	210106	110106.0			516004
2.0 Turbo H	(154)	12.85 - 09.86				GAS	210251	110251.0			516004
						GAS	210250	110250.0			516004
2.0 Turbo H	(154)	10.86 - 12.96				GAS	210251	110251.0			516004
				excl.		GAS	210106	110106.0			516004
2.0 Turbo	(154)	12.85 - 09.86				GAS	210251	110251.0			516004
						GAS	210250	110250.0			516004
2.0 Turbo	(154)	10.86 - 12.96				GAS	210251	110251.0			516004
				excl.		GAS	210106	110106.0			516004

CROMA II

excl.	(194)	06.05 -				GAS	210567	110567.1	110567.2	600770	516004
				excl.		GAS	211700	111700.0			-
	(194)	06.05 -				GAS	210568	110568.1	110568.2	600770	516004
				excl.		GAS	211701	111701.0			-

DOBLÒ

excl.	(119)	03.01 -				GAS	210147	110147.0	600011	600012	516004
						GAS	211284	111284.0			-
CARGO excl.	(223)	03.01 -				GAS	210147	110147.0	600011	600012	516004
						GAS	211284	111284.0			-

DOBLÒ II

Furgonato	(263)	01.10 -				GAS	210176	110176.1	110176.2	600541	600542	516004
						GAS	211307	111307.0			-	
Combi (trasporto persone)	(152, 263)	01.10 -				GAS	210176	110176.1	110176.2	600541	600542	516004
						GAS	212016	112016.0			-	

DOGAN / SAHIN





























































(Made in Egypt)						OIL	200137	100137.0			516004
						OIL	201384	101384.0			

DUCATO











10-13Q Panorama	(280)	01.82 - 04.84 07.82 - 04.84		15A		OIL	200206	100206.0			516007
				14A		OIL	201347	101347.0			-
	(280)	07.82 - 04.84		15A		OIL	200206	100206.0			516007
				14B		OIL	201348	101348.0			-
10Q 1000 Kg, 14Q 1400 Kg Panorama	(280, 290)	04.84 - 03.94		15A		OIL	200207	100207.0			516007
				14A		OIL	201347	101347.0			-













FIAT (I)

 Maxi 18Q 1800 Kg  4X4	(280, 290)	04.84 - 03.94		15A		OIL	200136	100136.0			516007
				14C		OIL	201278	101278.0			-
 excl. 4X4	(280, 290)	04.84 - 03.94		15A		OIL	200207	100207.0			516007
											-
Express 10 - 13 - 15	(280, 290)	04.84 - 03.94		15A		OIL	200207	100207.0			516007
				14A		OIL	201347	101347.0			-
				14B		OIL	201348	101348.0			-
 1000 Kg, 1400 Kg	(230)	01.94 - 04.02		15B		OIL	200265	100265.0	600071	600072	516007
				GAS	210265	110265.0					
				14D		OIL	201398	101398.0			-
				GAS	211398	111398.0			-		
 1800 Kg	(230)	01.94 - 04.02		15B		OIL	200280	100280.0	600071	600072	516007
				GAS	210280	110280.0					
				14E		OIL	201405	101405.0			-
				GAS	211405	111405.0			-		
Camping Car Grand Export	(230)	01.94 - 08.95		15B		OIL	200280	100280.0	600071	600072	516007
				GAS	210280	110280.0					
Camping Car Grand Export	(230)	09.95 - 04.02		15B		OIL	200280	100280.0	600071	600072	516007
				GAS	210280	110280.0					
 1000 Kg, 1400 Kg	(244)	04.02 - 05.06		15B		OIL	200265	100265.0	600071	600072	516007
				GAS	210265	110265.0					
				14D		OIL	201398	101398.0			-
				GAS	211398	111398.0			-		
 1800 Kg	(244)	04.02 - 05.06		15B		OIL	200280	100280.0	600071	600072	516007
				GAS	210280	110280.0					
				14E		OIL	201405	101405.0			-
				GAS	211405	111405.0			-		
 1000Kg 1400Kg	(250)	07.06 -		15Ca		GAS	210881	110881.0	600651	600652	516007
					14F		GAS	211296	111296.0		
 1400Kg 2000Kg	(250)	07.06 -		15Ca		GAS	210882	110882.0	600651	600652	516007
					14C		GAS	211301	111301.0		
 1000Kg 1400Kg REINFORCED	(250)	07.06 -		15Cb		GAS	210159	110159.0	600651	600652	516007
					14F		GAS	211296	111296.0		
 1400Kg 2000Kg REINFORCED	(250)	07.06 -		15Cb		GAS	210167	110167.0	600651	600652	516007
					14G		GAS	211301	111301.0		

DUNA/CITY VAN/PENNY/PREMIO







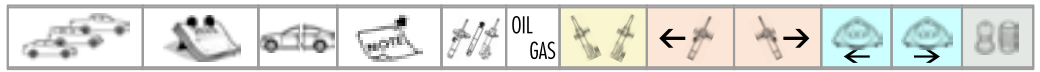



































	(146B)	01.87 - 12.91				OIL	200253	100253.0			516004
						OIL	200254	100254.0			516004
 Weekend, Panorama, Van	(146B)	01.87 - 12.91				OIL	200253	100253.0			516004
						OIL	200254	100254.0			516004

FIORINO











 > Ch. 7017071 (Made in Europe)	(127)	10.77 - 06.82				OIL	200240	100240.0			516004
						OIL	200134	100134.0			516004
 Ch. 7017072 > (Made in Europe)	(127)	07.82 - 12.84				OIL	200240	100240.0			516004
						OIL	200242	100242.0			516004













FIAT (I)

  (Made in Brazil)	(127)	07.82 - 12.87			OIL	200241	100241.0			516004
					OIL	200242	100242.0			516004
  (Made in Brazil)	(127)	01.87 - 12.88			OIL	200253	100253.0			516004
					OIL	200254	100254.0			516004
  (Made in Brazil) Ch. 8000001 > 8149536	(146, 147)	01.88 - 12.90			OIL	200253	100253.0			516004
					OIL	200266	100266.0			
  (Made in Brazil) Ch. 8149537 >	(146, 147)	01.91 - 07.93			OIL	200267	100267.0			516004
					OIL	200266	100266.0			
  (Made in Brazil)	(146, 147)	08.93 - 05.01			OIL	200267	100267.0			516004
					OIL	201399	101399.0			-
					GAS	211399	111399.0			-
 excl. Natural power N.D. Finestrato	(225)	11.07 -			GAS	210173	110173.1 110173.2	600541	600542	516004
					GAS	211305	111305.0			-
 excl. Natural power H.D. Cassonato	(225)	11.07 -			GAS	210173	110173.1 110173.2	600541	600542	516004
					GAS	212012	112012.0			-











FREEMONT

 excl. 4x4	(345)	08.11 -			GAS	210880	110880.1 110880.2			516004
					GAS	211207	111207.0			
 4x4	(345)	08.11 -			GAS	212138	112138.1 112138.2			516004
					GAS	211207	111207.0			





FULLBACK *NEW*

 excl. 4x4	(502, 503)	04.16 -			GAS					
					GAS					-
 4x4	(502, 503)	04.16 -			GAS					
					GAS					-











IDEA

 1.2 16V, 1.4 16V	(350)	01.04 -			GAS	210164	110164.0	600130		516004
					GAS	211290	111290.0			-
 1.3 JTD, 1.9 JTD	(350)	01.04 -			GAS	210153	110153.0	600130		516004
					GAS	211290	111290.0			-











LINEA

	(323, 110)	10.06 -			GAS	210156	110156.1 110156.2	600500		516004
					GAS	211294	111294.0	600781	600782	516010

MAREA

 Weekend 1.2, 1.4, 1.6, 1.8	(185)	09.96 - 05.02			GAS	210281	110281.0	600690		516004
					GAS	211404	111404.0			-
 Weekend 1.9 TD, 1.9 JTD	(185)	09.96 - 05.02			GAS	210282	110282.0	600690		516004
					GAS	211409	111409.0			-

MULTIPLA

 excl. Bipower, blupower	(186)	04.99 - 06.10			GAS	210139	110139.0	600510		516004
					GAS	211404	111404.0			-
 Bipower, blupower	(186)	04.99 - 06.10			GAS	210152	110152.0	600510		516004
					GAS	211404	111404.0			-

FIAT (I)

PALIO/SIENA

	(178BX)	04.96 - 02.01			/	GAS	210006	110006.0			516004
						GAS	210138	110138.0	600011	600012	516004
	(178DX)	04.96 - 02.01			/	GAS	210006	110006.0			516004
						GAS	210138	110138.0	600011	600012	516004
		03.01 -			/	GAS	210172	110172.0	600011	600012	516004
						GAS	211282	111282.0			516010
		03.01 -			/	GAS	210172	110172.0	600011	600012	516004
						GAS	211404	111404.0			-

PANDA I

	excl. 4X4	(141A)	03.80 - 02.86				OIL	200255	100255.0	600570	516004
							GAS	210255	110255.0		516004
	excl. 4X4	(141A)	03.86 - 09.03				OIL	201390	101390.0		-
							GAS	210255	110255.0	600570	516004
	4X4	(141A)	09.83 - 07.04		17A		GAS	210269	110269.0		600570
							OIL	201275	101275.0		-
	4x4 Rialzata	(141A)	09.83 - 07.04		17B		GAS	211275	111275.0		-
							OIL	201274	101274.0		-
	4x4	(141A)	09.83 - 07.04				GAS	211274	111274.0		-
							OIL	201275	101275.0		-
	4x4 Rialzata	(141A)	09.83 - 07.04				GAS	210171	110171.0		516004
							OIL	200171	100171.0		516004
	4x4 Rialzata	(141A)	09.83 - 07.04				GAS	210171	110171.0		516004
							OIL	200171	100171.0		516004
	4x4 Rialzata	(141A)	09.83 - 07.04		17B		OIL	200171	100171.0		516004
							GAS	210171	110171.0		516004
	4x4 Rialzata	(141A)	09.83 - 07.04		17B		OIL	201275	101275.0		-
							GAS	211275	111275.0		-

PANDA II

	excl. 4X4, easy power, natural power, van. 100 hp	(169)	09.03 -				GAS	210154	110154.1	110154.2	600130	516004
							GAS	211291	111291.0			-
	100 hp	(169)	10.06 -				GAS	212253	112253.1	112253.2		
							GAS	212254	112254.0			-
	4x4	(169)	09.03 -		17C		GAS	210155	110155.1	110155.2	600130	516004
							GAS	211292	111292.0			-
	Van	(169)	09.03 -				GAS	210154	110154.1	110154.2	600130	516004
							GAS	211300	111300.0			-
	1.2 Easy power (Gpl)	(169)	01.07 - 09.10 -				GAS	210878	110878.1	110878.2	600130	516004
							GAS	211292	111292.0			-
	1.2 Natural power (Metano)	(169)	01.07 - 12.11				GAS	210879	110879.1	110879.2	600130	516004
							GAS	212017	112017.0			-
	1.4 Easy power (Gpl)	(169)	09.10 - 08.13				GAS	210879	110879.1	110879.2	600130	516004
							GAS	212017	112017.0			-
	4x4 Rialzata	(169)	09.03 -		17D		GAS	210174	110174.1	110174.2	600130	516004
							GAS	211306	111306.0			-
	4x4 Rialzata	(169)	09.03 -		16		GAS	210174	110174.1	110174.2	600130	516004
							GAS	211306	111306.0			-

PANDA III

	incl. LPG, excl. 4X4	(312, 319)	02.12 -				GAS	210883	110883.1	110883.2		516004
							GAS	212011	112011.0			-
	4X4, Natural power	(312, 319)	06.12 -				GAS	210887	110887.1	110887.2		516004
							GAS	212018	112018.0			-

FIAT (I)

Rialzata	(312, 319)	02.12 -				GAS	212204	112204.1	112204.2			516004
						GAS	212205	112205.0				-

PUNTO I

1.1, 1.2, 1.6, 1.7 D	(176)	11.93 - 09.99				GAS	210261	110261.0		600520	516004
						GAS	211397	111397.0			-
1.2, 1.6	(176C)	04.94 - 06.00				GAS	210262	110262.0		600520	516004
						GAS	211397	111397.0			-
1.4 Turbo GT	(176)	01.94 - 09.99				GAS	210262	110262.0		600520	516004
						GAS	211397	111397.0			-
1.7 TD	(176)	01.94 - 09.99				GAS	210262	110262.0		600520	516004
						GAS	211397	111397.0			-

PUNTO II

1.2, 1.2 16V, 1.4, 1.3 JTD excl.	(188)	09.99 - 03.12				GAS	210141	110141.0		600130	516004
						GAS	211280	111280.0			-
1.9 D, 1.9 JTD	(188)	09.99 - 03.12				GAS	210142	110142.0		600130	516004
						GAS	211280	111280.0			-
1.2 16V Sporting 1.8 16V HGT	(188)	09.99 - 03.12				GAS	210143	110143.0		600130	516004
						GAS	211281	111281.0			-

PUNTO III (GRANDE PUNTO)

incl. Natural power	(199)	06.05 -				GAS	210156	110156.1	110156.2	600500	516004
						GAS	211294	111294.0		600781	600782

PUNTO EVO

	(199)	07.08 - 02.12				GAS	210177	110177.1	110177.2	600500	516004
						GAS	211308	111308.0			516010

QUBO

excl. Natural power N.D. Finestrato	(255)	02.08 -				GAS	210173	110173.1	110173.2	600541	600542	516004
						GAS	211305	111305.0			-	

REGATA

	(138)	09.83 - 12.90				OIL	200257	100257.0			516004
						OIL	200683	100683.0			
Weekend	(138)	01.84 - 06.91				OIL	200257	100257.0			516004
						OIL	200263	100263.0			

RITMO I / STRADA

excl. 125 TC	(138A, 178E)	01.78 - 10.82				OIL	200256	100256.0		600570	516004
						OIL	200683	100683.0			
125 TC	(138A, 178E)	11.81 - 10.82				GAS	210149	110149.0			516004
						OIL	200683	100683.0			
excl. Abarth	(138A, 178E)	11.82 - 12.88				OIL	200257	100257.0			516004
						OIL	200683	100683.0			
Abarth 125, 130 TC	(138A, 178E)	11.82 - 12.88				GAS	210150	110150.0			516004
						OIL	200683	100683.0			

SCUDO

(> Ch. 7609)	(220L, 220P)	02.96 - 09.97				GAS	210270	110270.0		600741	600742	516004
				18A		GAS	211401	111401.0			-	

FIAT (I)

🚗 (Ch. 7610 > 9793)	(220L, 220P)	09.97 - 10.03				GAS	210270	110270.0	600741	600742	516004	
				18B		GAS	211351	111351.0			-	
🚗 (Ch. 9794 > 10408)		10.03 - 05.04				GAS	210166	110166.1	110166.2	600741	600742	516004
				18B		GAS	211351	111351.0			-	
🚗 (Ch. 10409 >)		05.04 - 02.07				GAS	210270	110270.0	600741	600742	516004	
				18B		GAS	211351	111351.0			-	
🚗 1.6D, 2.0 D excl H.D.	(270, 272)	01.07 -				GAS	210169	110169.1	110169.2	600741	600742	516004
				18C		GAS	211303	111303.0			-	
🚗 1.6D, 2.0 D H.D.	(270, 272)	01.07 -				GAS	210170	110170.1	110170.2	600741	600742	516004
				18D		GAS	211304	111304.0			-	

SEDICI

🚗 1.6 ie	(FY)	06.06 - 10.14				GAS	210158	110158.1	110158.2			516004
						GAS	211295	111295.0				
🚗 1.9 JTD	(FY)	06.06 - 10.14				GAS	210165	110165.1	110165.2			516004
						GAS	211299	111299.0				

SEICENTO

🚗 excl. Sporting 🚗 Van	(187)	01.98 - 01.10				OIL	200140	100140.0	600580		516004
						GAS	210140	110140.0			
🚗 Sporting	(187)	01.98 - 01.10				OIL	201389	101389.0			-
						GAS	210283	110283.0	600580		516004
						OIL	201389	101389.0			-

STILO

🚗 1.2, 1.6	(192)	09.01 - 11.06		19		GAS	210144	110144.0	600560		516004
						GAS	211283	111283.0			516010
🚗 1.8, 1.9 JTD	(192)	09.01 - 11.06		19		GAS	210145	110145.0	600560		516004
						GAS	211283	111283.0			516010
🚗 2.4 20V, GT Abarth	(192)	09.01 - 11.06		19		GAS	210146	110146.0	600560		516004
						GAS	211283	111283.0			516010
🚗 Multiwagon 1.6	(192)	01.03 - 08.08		19		GAS	210144	110144.0	600560		516004
						GAS	211293	111293.0			-
🚗 Multiwagon 1.8, 1.9 JTD	(192)	01.03 - 08.08		19		GAS	210145	110145.0	600560		516004
						GAS	211293	111293.0			-
🚗 1.9 JTD 140CV 🚗 1.9D Multijet 150CV	(192)	01.04 - 11.06 09.05 - 11.06				GAS	210175	110175.0	600560		516004
						GAS	211283	111283.0			516010

STRADA



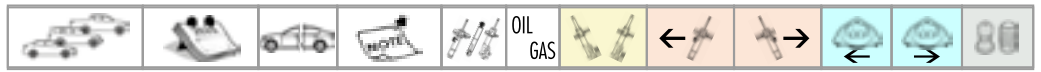

🚗	(178)	06.99 -				GAS	210138	110138.0	600011	600012	516004
						GAS	211399	111399.0			-
🚗 1.2, 1.9 JTD	(278)	01.09 -		OE 51791061		GAS	210172	110172.0	600011	600012	516004
						GAS	211399	111399.0			-
🚗 1.4, 1.6, 1.8		06.12 -				GAS	212131	112131.0			516004
						GAS	212132	112132.0			-

TALENTO



🚗	(290)	03.89 - 03.94				OIL	200207	100207.0			516004
				14A		OIL	201347	101347.0			-



































FIAT (I)

	(290)	03.89 - 03.94		14B		OIL	200207	100207.0			516004
						OIL	201348	101348.0			-











TALENTO II

	(296)	06.16 -				GAS	212110	112110.0			516004
						GAS	212111	112111.0			-





TEMPRA

	(159)	03.90 - 08.97				GAS	210258	110258.0	600690		516004
						GAS	211391	111391.0			-
	(159)	03.90 - 08.97				GAS	210259	110259.0	600751	600752	516004
						GAS	211391	111391.0			-
	(159)	03.90 - 08.97		excl. 		GAS	210258	110258.0	600690		516004
						GAS	211391	111391.0			-
	(159)	03.90 - 08.97		excl. 		GAS	210259	110259.0	600751	600752	516004
						GAS	211391	111391.0			-
	(159)	03.90 - 08.97				GAS	210259	110259.0	600751	600752	516004
										-	
	(159)	03.90 - 08.97				GAS	210259	110259.0	600751	600752	516004
						GAS	211409	111409.0			-











TIPO

	(160)	07.87 - 04.95				GAS	210258	110258.0	600690		516004
						GAS	211391	111391.0			-
	(160)	07.87 - 04.95				GAS	210259	110259.0	600751	600752	516004
						GAS	211404	111404.0			-





TIPO II

	(356)	03.16 -				GAS	210892	110892.1	110892.2	600500	516004
						GAS	212020	112020.0	600781	600782	516010













ULYSSE I

	(220)	03.94 - 12.97		18A		GAS	210270	110270.0	600741	600742	516004
						GAS	211401	111401.0			-
	(220)	01.98 - 08.02		18B		GAS	210270	110270.0	600741	600742	516004
						GAS	211351	111351.0			-

ULYSSE II

	(179AX)	08.02 - 06.11				GAS	210447	110447.1	110447.2	600741	600742	516004
						GAS	211289	111289.0			-	





UNO

	(146A/E)	01.83 - 12.96				OIL	200260	100260.0	600640	516004
						GAS	210260	110260.0		
						OIL	201392	101392.0	600790	
						GAS	211392	111392.0		
	(146A/E)	01.83 - 12.96				GAS	210260	110260.0	600640	516004
						GAS	211392	111392.0	600790	















FIAT (I)

UNO (CS)

 (Made in Brazil)	(CS)	01.88 - 12.91				OIL	200253	100253.0			516004
						OIL	200254	100254.0			516004

X 1/9

1,3	(128AS)	11.72 - 12.79				OIL	200277	100277.0			516004
						OIL	200278	100278.0			
1.5 Europa	(128AS)	11.78 - 12.89				OIL	200277	100277.0			516004
						OIL	200279	100279.0			
1.5 USA	(128AS)					OIL	200277	100277.0			516004
						OIL	200151	100151.0			

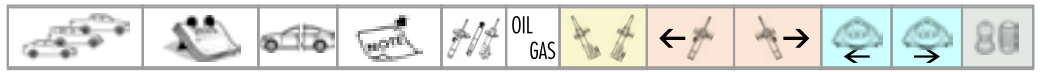

FORD (EUR)

B-MAX

	(JK)	10.12 -				GAS	210344	110344.1	110344.2			516004
						GAS	211456		111456.0			516010

C-MAX

	(DM2)	02.07 - 09.10				GAS	210332	110332.1	110332.2	600480		516004
						GAS	211444		111444.0		600400	
	(DXA/CB7, DXA/CEU)	12.10 -				GAS	210342	110342.1	110342.2			516004
						GAS	211444		111444.0		600400	

COUGAR

	(EC)	08.98 - 12.01				GAS	210322		110322.0			516004
						GAS	210326		110326.0			516004

ECOSPORT











	(EC)	08.98 - 12.01				GAS	210322		110322.0			516004
						GAS	210326		110326.0			516004

ESCORT III/IV (80-90)





































	(GAA, AWA)	09.80 - 08.81				OIL	200284		100284.0			516004
						GAS	210285		110285.0			
	(GAA, AWA)	09.81 - 05.83				OIL	200284		100284.0			516004
						GAS	210285		110285.0			
	(GAF, AWF, AVF, ABFT)	06.83 - 11.84				GAS	210286		110286.0			516004
						GAS	210285		110285.0			
	(GAF, AWF, AVF, ABFT)	12.84 - 01.86				GAS	210286		110286.0			516004
						GAS	210285		110285.0			
	(GAF, AWF, AVF, ABFT)	01.86 - 07.90				GAS	210286		110286.0			516004
						GAS	210285		110285.0			
	(GAF, AWF, AVF, ABFT)	06.83 - 11.84				GAS	210287		110287.0			516004
						GAS	210285		110285.0			
	(GAF, AWF, AVF, ABFT)	12.84 - 01.86				GAS	210287		110287.0			516004
						GAS	210285		110285.0			
	(GAF, AWF, AVF, ABFT)	02.86 - 07.90				GAS	210287		110287.0			516004
						GAS	210285		110285.0			
	(GAF, AWF, AVF, ABFT)	10.82 - 05.83										516004
						GAS	210285		110285.0			
	(GAF, AWF, AVF, ABFT)	06.83 - 11.84				GAS	210286		110286.0			516004
						GAS	210285		110285.0			
	(GAF, AWF, AVF, ABFT)	12.84 - 07.90				GAS	210286		110286.0			516004
						GAS	210285		110285.0			
	(GAF, AWF, AVF, ABFT)	06.83 - 11.84				GAS	210286		110286.0			516004
						GAS	210285		110285.0			
	(GAF, AWF, AVF, ABFT)	12.84 - 01.86				GAS	210286		110286.0			516004
						GAS	210285		110285.0			
	(ALD)	06.83 - 11.84				GAS	210286		110286.0			516004
						GAS	210285		110285.0			
	(ALF)	12.84 - 07.90				GAS	210286		110286.0			516004
						GAS	210285		110285.0			



FORD (EUR)

























































↳ 1.6 XR3i	(ALD)	06.83 - 11.84				GAS	210286	110286.0			516004
							GAS	210285	110285.0		
↳ 1.6 XR3i	(ALF)	12.84 - 07.90				GAS	210286	110286.0			516004
							GAS	210285	110285.0		
↳ 35, 55	(AVA)	01.81 - 05.83									516004
↳ 35, 55	(AVA)	06.83 - 11.84				OIL	200290	100290.0			516004
							OIL	201413	101413.0		
↳ 35, 55	(AVF)	12.84 - 09.90				OIL	200290	100290.0			516004
							OIL	201413	101413.0		

ESCORT V/VI (90-95)











↳ 1.1, 1.3 ↳ 1.4	(GAL)	08.90 - 01.95 08.90 - 10.90		20A		GAS	210288	110288.0			516004
							GAS	211045	111045.0		
↳ 1.4 ↳ 1.6	(GAL)	10.90 - 01.95 08.90 - 01.95		20B		GAS	210289	110289.0			516004
							GAS	211045	111045.0		
↳ 1.4i, 1.6i	(GAL)	08.90 - 01.95		20B		GAS	210289	110289.0			516004
							GAS	211045	111045.0		
↳ 1.8i excl. ❄	(GAL)	01.92 - 01.95		20B		GAS	210289	110289.0			516004
							GAS	211045	111045.0		
↳ 1.8i ❄	(GAL)	01.92 - 01.95		20B		GAS	210289	110289.0			516004
							GAS	211045	111045.0		
↳ 1.8 D	(GAL)	08.90 - 10.90		20A		GAS	210288	110288.0			516004
							GAS	211045	111045.0		
↳ 1.8 D, 1.8 TD	(GAL)	11.90 - 01.95		20B		GAS	210289	110289.0			516004
							GAS	211045	111045.0		
↳ 1.8 16V XR3i	(GAL)	02.92 - 01.95		20B		GAS	210289	110289.0			516004
							GAS	211045	111045.0		
↳ RS 2000 4X2	(GAL)	09.92 - 01.95				GAS	210310	110310.0			516004
							GAS	211050	111050.0		
↳ RS Turbo 4x4 excl. Cosworth	(GAL)	08.93 - 01.95									
↳ RS Cosworth 4x4	(GAL)	09.92 - 01.95				GAS	210320	110320.0			516004
↳ 1.4	(GAL, AVL)	08.90 - 10.90		20A		GAS	210288	110288.0			516004
↳ 1.4, 1.8i ↳ 1.4i, 1.6, 1.6i, 1.6i 16V	(GAL, AVL)	10.90 - 01.95 08.90 - 01.95		20B		GAS	210289	110289.0			516004
↳ 1.8 D	(GAL, AVL)	08.90 - 10.90		20A		GAS	210288	110288.0			516004
↳ 1.8 D, 1.8 TD	(GAL, AVL)	10.90 - 01.95		20B		GAS	210289	110289.0			516004
↳	(ALL)	12.92 - 01.95		20B		GAS	210289	110289.0			516004
↳ 500 kg	(AVL)	07.90 - 12.94		20A		GAS	210288	110288.0			516004
↳ 700 kg	(AVL)	07.90 - 12.94		20B		GAS	210289	110289.0			516004

FORD (EUR)









ESCORT VII (95-00)

 1.3i	(GAL, AAL, ABL, AFL)	01.95 - 02.99		20C		GAS	210318	110318.0			516004
							GAS	211052	111052.0		
 1.4i, 1.6i	(GAL, AAL, ABL, AFL)	01.95 - 02.99		20C		GAS	210318	110318.0			516004
							GAS	211052	111052.0		
 1.6i 16V, 1.8i, 1.8i 16V excl. 4X4	(GAL, AAL, ABL, AFL)	01.95 - 02.99		20C		GAS	210318	110318.0			516004
							GAS	211052	111052.0		
 1.8 D, 1.8 TD	(GAL, AAL, ABL, AFL)	01.95 - 02.99		20C		GAS	210318	110318.0			516004
							GAS	211052	111052.0		
 RS 2000 16V 4X2 excl. 4X4	(GAL, AAL, ABL, AFL)	01.95 - 02.99		20C		GAS	210318	110318.0			516004
											
1.6i 4x4 RS 2000 4x4 excl. Cosworth	(GAL, AAL, ABL, AFL)	01.95 - 10.98									516004
		01.95 - 10.98									-
 Clipper 1.3i	(GAL, ANL)	08.95 - 02.99		20A		GAS	210288	110288.0			516004
				20E		GAS	211436	111436.0			
 Clipper 1.4i, 1.6i, 1.6i 16V, 1.8i, 1.8i 16V  Clipper 1.8 D, 1.8 TD	(GAL, ANL)	01.95 - 08.95		20C		GAS	210318	110318.0			516004
		01.95 - 08.95		20D		GAS	211412	111412.0			
 Clipper 1.4i, 1.6i, 1.6i 16V, 1.8i, 1.8i 16V  Clipper 1.8 D, 1.8 TD	(GAL, ANL)	08.95 - 02.99		20C		GAS	210318	110318.0			516004
		08.95 - 02.99		20E		GAS	211436	111436.0			
	(ALL)	01.95 - 08.00		20C		GAS	210318	110318.0			516004
							GAS	211052	111052.0		
 500 kg	(AVL)	01.95 - 08.00		20C		GAS	210318	110318.0			516004
							OIL	201414	101414.0		
 700 kg	(AVL)	01.95 - 08.00		20C		GAS	210318	110318.0			516004
							OIL	201414	101414.0		





















EXPLORER

	(U2)	01.91 - 10.94				GAS	211431	111431.0			
						GAS	211432	111432.0			
	(U2)	11.94 -				GAS	211433	111433.0			
						GAS	211434	111434.0			

FIESTA I







































 excl. XR2	(GFBT)	05.76 - 08.83				OIL	200291	100291.0			
						OIL	200292	100292.0			
XR2	(GFBT)	1981 - 08.83				GAS	210293	110293.0			
						OIL	200292	100292.0			

FIESTA II









 excl. XR2	(FBD)	09.83 - 11.84				OIL	200294	100294.0			
						OIL	200292	100292.0			
 excl. XR2	(FBD)	12.84 - 12.88				OIL	200294	100294.0			
						OIL	200292	100292.0			
 XR2	(FBD)	09.83 - 11.84				GAS	210295	110295.0			
						OIL	200292	100292.0			
 XR2	(FBD)	12.84 - 02.89				GAS	210295	110295.0			
						OIL	200292	100292.0			

FORD (EUR)

FIESTA III

1.0, 1.1, 1.3, 1.4, 1.6, 1.8 D	(GFJ)	01.89 - 12.93		21A		GAS	210296	110296.0			516004
							GAS	211047	111047.0		
1.4 S, 1.6 S, 1.8 Si, 1.8 D, 1.8 TD	(GFJ)	01.89 - 12.93		21B		GAS	210297	110297.0			516004
							GAS	211047	111047.0		
1.6 XR2i, 1.8 16V XR2i, RS 1800	(GFJ)	01.89 - 12.93		21B		GAS	210297	110297.0			516004
							GAS	211047	111047.0		
1.6 Turbo	(GFJ)	03.90 - 12.93		21B		GAS	210297	110297.0			516004
							GAS	211049	111049.0		
excl. Courier	(GFJ)	01.89 - 12.93		21A		GAS	210296	110296.0			516004
							GAS	211047	111047.0		
1.1, 1.3, 1.4 C, CLX, Ghia, Youth Senza barra stabilizzatrice - without stabilizer	(GFJ)	01.94 - 12.95		21A		GAS	210311	110311.0			516004
							GAS	211048	111048.0		
1.1, 1.3, 1.4 C, CLX, Ghia, Youth Con barra stabilizzatrice - with stabilizer	(GFJ)	01.94 - 12.95		21C		GAS	210311	110311.0			516004
							GAS	211048	111048.0		
1.1, 1.3 SX, 1.6 1.4 Si, SX, Futura	(GFJ)	01.94 - 12.95		21C		GAS	210311	110311.0			516004
		01.94 - 12.95					GAS	211048	111048.0		
1.6 LX, Si, Futura		01.94 - 12.95				GAS	210309	110309.0			516004
							GAS	211051	111051.0		
1.8 D Senza barra stabilizzatrice - without stabilizer	(GFJ)	01.94 - 12.95		21A		GAS	210311	110311.0			516004
							GAS	211048	111048.0		
1.8 TD	(GFJ)	01.94 - 12.95		21C		GAS	210311	110311.0			516004
							GAS	211048	111048.0		
XR2i, RS 1800 Con barra stabilizzatrice - with stabilizer		01.94 - 12.95				GAS	210309	110309.0			516004
							GAS	211051	111051.0		
excl. Fiesta Courier	(GFJ)	01.94 - 12.95		21C		GAS	210311	110311.0			516004
							GAS	211048	111048.0		

FIESTA III CLASSIC











1.1, 1.3, 1.4, 1.8 D	(GFJ)	12.95 - 12.97		21A		GAS	210311	110311.0			516004
							GAS	211048	111048.0		
1.1, 1.3, 1.4, 1.6, 1.8 TD	(GFJ)	12.95 - 12.97		21C		GAS	210311	110311.0			516004
							GAS	211048	111048.0		
1.6 LX, Si, Futura	(GFJ)	12.95 - 12.97				GAS	210309	110309.0			516004
							GAS	211051	111051.0		

FIESTA IV











1.0, 1.25, 1.3 16V, 1.4 16V excl. Fiesta Classic	(JA, JB)	08.95 - 10.98				GAS	210313	110313.0	600310	516004
				21D		GAS	211054	111054.0	600360	
1.0, 1.25, 1.3 16V	(JA, JB)	11.98 - 12.01				GAS	210313	110313.0	600310	516004
				21E		GAS	211057	111057.0	600360	
1.4 16V, 1.6	(JA, JB)	11.98 - 12.01				GAS	210313	110313.0	600310	516004
				21D		GAS	211054	111054.0	600360	
1.8 D, 1.8 DI excl. Fiesta Classic	(JA, JB)	08.95 - 10.98				GAS	210316	110316.0	600310	516004
				21D		GAS	211054	111054.0	600360	
1.8 D, 1.8 DI	(JA, JB)	11.98 - 12.01				GAS	210316	110316.0	600310	516004
				21E		GAS	211057	111057.0	600360	

FORD (EUR)





FIESTA V

 excl. ST150	(JH, JD)	11.01 - 12.03				GAS	210330	110330.1	110330.2	600340	516004
						GAS	211442	111442.0		600460	
 excl. ST150	(JH, JD)	01.04 - 06.08				GAS	210487	110487.1	110487.2	600340	516004
						GAS	211442	111442.0		600460	





















FIESTA VI

	(CB1, CCN)	06.08 -				GAS	210337	110337.1	110337.2	600450	516004
						GAS	211447	111447.0		600460	
	(CB1, CCN)	09.12 -				GAS	210345	110345.1	110345.2	600970	516004
						GAS	211458	111458.0			













FIESTA VII *NEW*

		05.17 -				GAS	212248	112248.1	112248.2		516004
						GAS	212249	112249.0			-

















FIESTA COURIER

	(F3L, F5L)	07.91 - 12.93		21B		GAS	210297	110297.0			516004
						GAS	211428	111428.0			-
	(F3L, F5L)	01.94 - 12.95		21C		GAS	210311	110311.0			516004
						GAS	211428	111428.0			-
 excl. 1.8 D	(J5, J3)	02.96 - 08.03				GAS	210313	110313.0		600310	516004
						GAS	211428	111428.0			-
 1.8 D	(J5, J3)	02.96 - 08.03				GAS	210316	110316.0		600310	516004
						GAS	211428	111428.0			-

















FOCUS

 ,  , 	(DAW, DBW, DFW)	06.98 - 12.04				GAS	210324	110324.1	110324.2		516004
						GAS	211435	111435.0		600300	
	(DNW)	06.98 - 12.04				GAS	210324	110324.1	110324.2		516004
						GAS	211437	111437.0			-

FOCUS II





 ,  , 	(DA)	11.04 - 09.12				GAS	210332	110332.1	110332.2	600480	516004
						GAS	211444	111444.0		600400	
	(DAW)	11.04 - 09.12				GAS	210332	110332.1	110332.2	600480	516004
						GAS	211445	111445.0			-
		10.06 - 09.10				GAS	210332	110332.1	110332.2	600480	516004
						GAS	211453	111453.0			

FOCUS III





 , 		04.11 -				GAS	210343	110343.1	110343.2	600480	516004
						GAS	211454	111454.0		600400	516010
		05.11 - 10.14				GAS	210343	110343.1	110343.2	600480	516004
						GAS	211455	111455.0			-
		09.14 -				GAS	212142	112142.1	112142.2	600480	516004
						GAS	211455	111455.0		600400	516010

FORD (EUR)











FOCUS IV *NEW*

	(HN, HP)	09.18 -				GAS	212250	112250.1	112250.2			516004
						GAS	212251		112251.0			516010















FOCUS C-MAX

		10.03 - 03.07				GAS	210332	110332.1	110332.2	600480		516004
						GAS	211444		111444.0	600400		





















FUSION

	(JU)	08.02 - 12.03		22A		GAS	210331	110331.1	110331.2	600340		516004
						GAS	211443		111443.0			
	(JU)	01.04 - 12.12		22B		GAS	210333	110333.1	110333.2	600340		516004
						GAS	211443		111443.0			

























GALAXY

	(WGR)	02.95 - 05.06				GAS	210314	110314.0		600800		516004
						GAS	211429		111429.0			-
	(WA6)	05.06 - 06.15				GAS	210334	110334.1	110334.2	600180		516004
						GAS	211446		111446.0	600190		
	(CK)	01.15 -				GAS	212168	112168.1	112168.2			516006
						GAS	212113		112113.0			516001











GRANADA

	(GG_, GU, GNU)	01.72 - 04.85				OIL	201410	101410.0				
						OIL	201411		101411.0			
	(GAE, GGE)	03.85 - 10.94				GAS	210298	110298.0				516004
						GAS	211415		111415.0			-
	(GAE, GGE)	04.91 - 10.94				GAS	210299	110299.0				516004
						GAS	211415		111415.0			-
	(GAE, GGE)	02.92 - 10.94				GAS	210299	110299.0				516004
												

KA

	(RB)	09.96 - 10.98				GAS	210315	110315.0		600310		516004
					21D		GAS	211055	111055.0	600360		
	(RB)	11.98 - 03.00				GAS	210315	110315.0		600310		516004
					21E		GAS	211056	111056.0	600360		
	(RB)	04.00 - 04.03				GAS	210315	110315.0		600310		516004
							GAS	211058	111058.0	600360		
		04.03 - 12.07				GAS	210336	110336.1	110336.2			516004
							GAS	211058	111058.0	600360		
	(RU8)	10.08 -				GAS	210168	110168.1	110168.2			516004
							GAS	211302	111302.0			-

KUGA

		03.08 - 11.12				GAS	210340	110340.1	110340.2	600480		516004
						GAS	211450		111450.0	600400		516010
	(DM2)	10.12 -				GAS	212133	112133.1	112133.2			516004
						GAS	211450		111450.0	600400		516010

FORD (EUR)

MAVERICK

	(UDS, UNS)	02.93 - 06.96			o	GAS	211644	111644.0			
						o	GAS	211653	111653.0		

MONDEO I

 excl. 4x4	(GBP)	03.93 - 05.93			%	GAS	210305	110305.0			516004
						%	GAS	210306	110306.0		
 excl. 4x4	(GBP)	06.93 - 08.96			%	GAS	210307	110307.0			516004
						%	GAS	210306	110306.0		
 4x4 excl. 4x4	(BNP)	01.95 - 08.96			%	GAS	210307	110307.0			516004
						excl. 01	o				
 Clipper excl. 4x4	(BNP)	03.93 - 05.93			%	GAS	210305	110305.0			516004
						excl. 01	o	GAS	211427	111427.0	
 Clipper excl. 4x4	(BNP)	06.93 - 08.96			%	GAS	210307	110307.0			516004
						excl. 01	o	GAS	211427	111427.0	
 Clipper 4x4 excl. 4x4	(BNP)	01.95 - 08.96			%	GAS	210307	110307.0			516004
						excl. 01	o	GAS	211427	111427.0	

MONDEO II

 excl. 2.5 ST200, 4x4	(BAP, BFP)	09.96 - 10.00			%	GAS	210322	110322.0			516004
						%	GAS	210306	110306.0		
 Clipper excl. 4x4	(BNP)	09.96 - 10.00			%	GAS	210322	110322.0			516004
						excl. 01	o	GAS	211427	111427.0	

MONDEO III

 excl. 3.0 24V, ST220	(B4Y, B5Y)	10.00 - 08.07			%	GAS	210327	110327.0			516004
						%	GAS	210328	110328.0		
 Clipper excl. 3.0 24V, ST220	(BWY)	10.00 - 08.07			%	GAS	210327	110327.0			516004
						o	GAS	211438	111438.0		

MONDEO IV

	(BA7)	03.07 - 01.15			%	GAS	210334	110334.1	110334.2	600180	516004
						o	GAS	211446	111446.0		600190

MONDEO V



	(CD)	09.14 -			%	GAS	212112	112112.1	112112.2		516004
						o	GAS	212113	112113.0		

ORION I/II

 excl. 1.6i, 1.6 D	(AFD)	07.83 - 11.84			%	GAS	210286	110286.0			516004
						%	GAS	210285	110285.0		
 excl. 1.6i, 1.6 D	(AFD)	12.84 - 07.90			%	GAS	210286	110286.0			516004
						%	GAS	210285	110285.0		
 1.6i	(AFD)	01.83 - 11.84			%	GAS	210286	110286.0			516004
						%	GAS	210285	110285.0		
 1.6i	(AFF)	12.84 - 07.90			%	GAS	210286	110286.0			516004
						%	GAS	210285	110285.0		
 1.6 D	(AFF)	02.84 - 11.84			%	GAS	210287	110287.0			516004
						%	GAS	210285	110285.0		











FORD (EUR)

1.6 D	(AFF)	12.84 - 07.90				GAS	210287	110287.0			516004
						GAS	210285	110285.0			







ORION III

1.3 1.4	(GAL)	08.90 - 12.93 08.90 - 10.90		20A		GAS	210288	110288.0			516004
						GAS	211045	111045.0			
1.4 1.4i, 1.6, 1.6i, 1.8i excl.Ghia	(GAL)	10.90 - 12.93 08.90 - 12.93		20B		GAS	210289	110289.0			516004
						GAS	211045	111045.0			
1.4i, 1.6i, 1.8i Ghia	(GAL)	08.90 - 12.93		20B		GAS	210289	110289.0			516004
						GAS	211045	111045.0			
1.8 D	(GAL)	08.90 - 10.90		20A		GAS	210288	110288.0			516004
						GAS	211045	111045.0			
1.8 D, 1.8 TD	(GAL)	11.90 - 12.93		20B		GAS	210289	110289.0			516004
						GAS	211045	111045.0			







PICK-UP

Cortina, Taunus (1000 Kg)		1982 - 07.83				OIL	201424	101424.0			
											
Cortina, Taunus (1000 Kg)		08.83 - 1988				OIL	201424	101424.0			
											
2.0, 1.8 TD		10.87 - 12.92									
						OIL	201426	101426.0			







PROBE

excl. 3.0 V6, 4x4		08.88 - 07.93				GAS	210462	110462.0			
						GAS	210463	110463.0			
2.0 16V, 2.5 24V		07.93 - 03.98				GAS	210464	110464.1	110464.2		
						GAS	210465	110465.0			

PUMA

1.4, 1.6, 1.7	(EC)	03.97 - 10.98		21D		GAS	210323	110323.0	600310	516004
						GAS	211054	111054.0	600360	
1.4, 1.6, 1.7	(EC)	11.98 - 06.02		21E		GAS	210323	110323.0	600310	516004
						GAS	211057	111057.0	600360	

S-MAX

	(VA6)	05.06 - 12.14				GAS	210334	110334.1	110334.2	600180	516004
						GAS	211446	111446.0	600190		
NEW	(CJ, WA6)	01.15 -				GAS	212168	112168.1	112168.2		516006
						GAS	212113	112113.0		516001	

SCORPIO I

excl. 2.9 24V, 4X4	(GAE, GGE)	03.85 - 10.94		excl. 4x4		GAS	210298	110298.0			516004
						GAS	211415	111415.0			-
2.9 24V excl. 4X4	(GAE, GGE)	04.91 - 10.94		excl. 4x4		GAS	210299	110299.0			516004
						GAS	211415	111415.0			-
		02.92 - 10.94				GAS	210299	110299.0			516004
											

FORD (EUR)

SCORPIO II

2.0, 2.0 16V, 2.3 16V 2.5 TD, 2.9, 2.9 24V	(GFR, GGR)	10.94 - 08.98				GAS	210335	110335.1	110335.2			516004
				excl.		GAS	211415	111415.0				-

SIERRA

excl. XR4i	(GBC)	08.82 - 04.84				GAS	210300	110300.0				516004
						GAS	211416	111416.0				-
2.8 XR4i	(GBC)	08.82 - 04.84				GAS	210300	110300.0				516004
						GAS	211416	111416.0				-
1.6, 1.8, 2.0 excl. 4X4, RS Cosworth 1.8 TD, 2.3 D excl. 4X4	(GBC, GBG)	05.84 - 02.93				GAS	210301	110301.0				516004
						GAS	211416	111416.0				-
2.8 V6, 2.9 V6, XR4i excl. 4X4, RS Cosworth	(GBC, GBG)	05.84 - 02.93				GAS	210301	110301.0				516004
						GAS	211416	111416.0				-
4x4 excl. RS Cosworth	(GBC, GBG)	05.84 - 02.93				GAS	210321	110321.0				516004
												-
4x2 RS Cosworth	(GBC, GBG)	1986 - 1990				GAS	210312	110312.0				516004
												-
4x4 RS Cosworth	(GBC, GBG)	1990 - 1993				GAS	210321	110321.0				516004
												-
excl. 4X4	(BNC)	08.82 - 04.84				GAS	210300	110300.0				516004
						GAS						
excl. 4X4	(BNC, BNG)	05.84 - 02.93				GAS	210301	110301.0				516004
						GAS						
4X4	(BNC, BNG)	05.84 - 02.93				GAS	210321	110321.0				516004
						GAS						

TOURNEO

Courier Kombi excl. Connect, Grand Connect Kombi, Custom autobus	(B460)	02.14 -				GAS	210344	110344.1	110344.2			516004
						GAS	211456	111456.0				516010
Connect, Grand Connect excl. Kombi, Custom autobus	(V408)	09.13 -				GAS	212169	112169.1	112169.2			516004
						GAS	211457	111457.0				-
Custom autobus	(V362, F3)	04.12 -				GAS	212170	112170.0				516007
						GAS	212171	112171.0				-

TRANSIT



FT 75, FT 100 FT 80, FT 100, FT 120	x= 2.69 m x= 2.69 m	(71E, 72E, 73E, 74E, 81E,V)	09.70 - 12.77 01.78 - 10.85				OIL	201418	101418.0			-
							OIL	201420	101420.0			-
FT 125, FT 130, FT 150, FT 175 FT 100L, FT 130, FT 160, FT 190	x= 3.02 m x= 3.02 m	(71E, 72E, 73E, 74E, 81E,V)	09.70 - 12.77 01.78 - 10.85				OIL	201418	101418.0			-
							OIL	201420	101420.0			-
		(71E, 72E, 73E, 74E, 81E,V)	09.70 - 12.85				OIL	201418	101418.0			-
							OIL	201420	101420.0			-
80, 100, 115, 120 x= 2.82 m	(T)		11.85 - 08.91				OIL	200302	100302.0			516007
							OIL	201421	101421.0			-
100L, 130, 160, 190 x= 3.02 m, 3.47 m	(T)		11.85 - 08.91				OIL	201422	101422.0			516007
							OIL	201421	101421.0			-
80, 100, 115, 120, 150 S e*o = 2.84 m	(E)		09.91 - 08.94				OIL	200303	100303.0			516007
							GAS	210303	110303.0			516007
							OIL	201418	101418.0			-

FORD (EUR)











130, 150 S, 100 L, 150 L, 190 L * = 3.57 m	(E)	09.91 - 08.94				OIL	200303	100303.0			516007			
						GAS	210303	110303.0			516007			
						OIL	201423	101423.0			-			
190 * = 3.57 m	(E)	09.91 - 08.94				OIL	200303	100303.0			516007			
						GAS	210303	110303.0			516007			
						OIL	201418	101418.0			-			
80, 100, 115, 120 * = 2.84 m	(E)	09.94 - 12.99				OIL	200303	100303.0			516007			
						GAS	210303	110303.0			516007			
						OIL	201418	101418.0			-			
150 S * = 2.84 m	(E)	09.94 - 12.99				OIL	200303	100303.0			516007			
						GAS	210303	110303.0			516007			
						OIL	201423	101423.0			-			
100L, 130, 150 L, 190 L * = 3.57 m	(E)	09.94 - 12.99				OIL	200303	100303.0			516007			
						GAS	210303	110303.0			516007			
						OIL	201423	101423.0			-			
190, 190EF * = 3.57 m	(E)	09.94 - 12.99				GAS	210303	110303.0			516007			
Tourneo, excl. 350L ☉		01.00 - 05.06				GAS	210329	110329.0			516007			
							23A		OIL	201439	101439.0			-
									GAS	211439	111439.0			-
☉		01.00 - 05.06				GAS	210329	110329.0			516007			
							23B		OIL	201440	101440.0			-
									GAS	211440	111440.0			-
* = 2.93 m excl. ☐ * = 3.13 m excl. ☐ ☉		01.00 - 05.06				GAS	210329	110329.0			516007			
							23C		OIL	201441	101441.0			-
* = 3.30 m, * = 3.75 m * = 3.50 m, * = 3.95 m excl. ■■, ☐ ☉		01.00 - 05.06				GAS	210329	110329.0			516007			
							23C		OIL	201441	101441.0			-
300M, 300S ☉ Incl. Tourneo		07.06 - 08.14		L=414		GAS	210339	110339.0	600490		516007			
							23D		GAS	211449	111449.0			-
330L, 330M, 350L, 350M ☉, Incl. Tourneo		07.06 - 08.14		L=432		GAS	210341	110341.0	600490		516007			
							23E		GAS	211451	111451.0			-
☉ Incl. Tourneo		07.06 - 08.14				GAS	210341	110341.0	600490		516007			
							23F		GAS	211452	111452.0			-
330S ☉ Incl. Tourneo		07.06 - 08.14				GAS	210341	110341.0	600490		516007			
							23C		GAS	211441	111441.0			-
Courier Kombi excl. Connect, Furgonato, Custom, Pianale		01.14 -				GAS	210344	110344.1	110344.2		516004			
									GAS	211457	111457.0			516010
excl. 4WD, RWD (FCD, FDD)		08.13 -				GAS	212170	112170.0			516007			
									GAS	212171	112171.0			-
RWD excl. 4WD (FCD, FDD)		08.13 -												
excl. 4WD, RWD (FAD, FBD)		08.13 -				GAS	212170	112170.0			516007			
RWD excl. 4WD (FAD, FBD)		08.13 -												
excl. 4WD, RWD (FED, FFD)		08.13 -				GAS	212170	112170.0			516007			







FORD (EUR)

 RWD excl. 4WD	(FED, FFD)	08.13 -										
												





TRANSIT CONNECT

	(P65, P70, P80)	06.02 - 12.13				GAS	210338	110338.1	110338.2	600470	516004
						GAS	211448	111448.0			
 *NEW*		02.13 -				GAS	212169	112169.1	112169.2		516004
						GAS	211457	111457.0			

TRANSIT COURIER

	(B460)	02.14 -				GAS	210344	110344.1	110344.2		516004
						GAS	211456	111456.0			



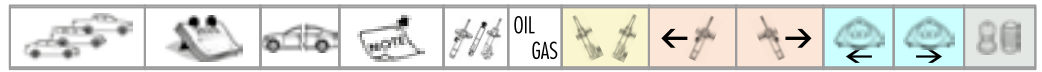

TRANSIT CUSTOM *NEW*

	(V362, FY, FZ)	04.12 -				GAS	212170	112170.0			516007
						GAS	212171	112171.0			







HONDA (J)













ACCORD I/II

	(SY, AC, AD)	10.81 - 05.85			GAS	210346	110346.0			516004
					GAS	210347	110347.0			516004





















ACCORD III

	(CA4, CA5)	06.85 - 12.89			GAS	210348	110348.0			516004
					GAS	210349	110349.0			516004









ACCORD IV

	excl. 4WS	(CB1, CB3)	01.90 - 03.93			GAS	210350	110350.0			516004
						GAS	210351	110351.0			516004
	4WS	(CB7)	01.90 - 03.93			GAS	210350	110350.0			516004
											
	Aerodeck	(CB8)	01.91 - 12.93			GAS	210350	110350.0			516004
						GAS	210352	110352.0			516004









ACCORD V

		(CC7)	03.93 - 02.96			GAS	210350	110350.0			516004
						GAS	210351	110351.0			516004
	2.0	(CC1)	03.93 - 01.96			GAS	210350	110350.0			516004
						GAS	210376	110376.0			516004
	2.0, 2.2	(CD7, CD9, CE1, CE2)	09.93 - 09.98			GAS	210350	110350.0			516004
						GAS	210374	110374.0			516004
	1.8, 2.0, 2.2	(CE7, CE8, CE9)	01.96 - 09.98			GAS	210350	110350.0			516004
						GAS	210376	110376.0			516004
	2.0 D, 2.0 TD	(CF)	01.96 - 09.98			GAS	210376	110376.0			516004
											





ACCORD VI

	1.6, 1.8, 2.0, 2.0 TD	(CG7, CG8, CG9, CH2)	10.98 - 01.03			GAS	211061	111061.0			
						GAS	211062	111062.0			
	2.0 16V, 2.3 Vti	(CG4, CG3)	02.98 - 01.03			GAS	211066	111066.0			
						GAS	211067	111067.0			















ACCORD VII

	2.0i, 2.4i, 2.2 CDTi	(CL7, CL9, CN1)	02.03 - 09.12			GAS	210384	110384.0			516004
						GAS	211070	111070.0			
	2.0, 2.4, 2.2 CDTi	(CM1, CM2, CN2)	02.03 - 09.12			GAS	210384	110384.0			516004
						GAS	211071	111071.0			

ACCORD VIII























	excl. 	(CU)	06.08 -			GAS	210391	110391.1	110391.2			516004
						GAS	211075	111075.0				

CIVIC I/II







	(SL)	10.79 - 12.81			GAS	210353	110353.0			516004	
					GAS	210354	110354.0			516004	
	(SL)	01.82 - 09.83								516004	
					GAS	210354	110354.0			516004	
	excl.  CRX,  Shuttle	(AG, AH, AJ, AK, AL, AM)	10.83 - 10.87			GAS	210355	110355.0			516004
						GAS	211059	111059.0			

HONDA (J)











CIVIC III/BALLADE

 1.2, 1.3, 1.4  1.5, 1.6 > Ch. S100001	(EC) (ED)	10.87 - 12.88			GAS	210356	110356.0			516004
						210357	110357.0			516004
 1.2, 1.3, 1.4  1.5, 1.6 Ch. S100002 >	(EC) (ED)	01.89 - 11.91			GAS	210358	110358.0			516004
						210359	110359.0			516004
 1.6 4X4 Ch. S10...> S200000	(EE5)	01.89 - 12.90			GAS	210360	110360.0			516004
						210361	110361.0			516004
 1.6 4X4 Ch. S200001 >	(EE5)	01.90 - 11.91			GAS	210360	110360.0			516004
						210362	110362.0			516004

















CIVIC IV/BALLADE

 1.3, 1.5  1.6  1.5, 1.6	(EG) (EH)	10.91 - 11.95			GAS	210378	110378.1	110378.2		516004
	(EJ)	10.91 - 03.96				210363	110363.0			516004

























CIVIC IV/V

 1.4, 1.5  1.6, 1.8	(MA) (MB)	09.94 - 02.01			GAS	210378	110378.1	110378.2		516004
						210365	110365.0			516004
 1.4, 1.5, 1.6	(EJ9) (EK)	11.95 - 02.01			GAS	210378	110378.1	110378.2		516004
						210365	110365.0			516004

















CIVIC V

 1.6  1.6 VTEC, VTi	(EJ6) (EJ7, EJ8, EM1)	11.95 - 02.01			GAS	211063	111063.0			
		11.95 - 02.01				210365	110365.0			516004
 2.0 ltd	(MB7)	01.97 - 02.01			GAS					516004
						211069	111069.0			
 Aerodeck 1.4, 1.5, 1.6, 1.8, 2.0i TD	(MB, MC)	04.98 - 02.01			GAS	210378	110378.1	110378.2		516004
						211069	111069.0			





CIVIC VI

 (3 m),   excl. 1.7 CTDi, 2.0 sport, R type	(EM2, EP1, EP2, ES4, ES5)	02.01 - 09.05			GAS	210385	110385.1	110385.2		516004
						211064	111064.0			
 (5 m) excl. 1.7 CTDi, 2.0 sport, R type	(EU5/7, EU6/8)	02.01 - 02.06			GAS	210385	110385.1	110385.2		516004
						211068	111068.0			
 (3/5 m) 1.7 CTDi  (5 m) 2.0i  (3 m) 2.0  R type	(EP, EU9)	04.02 - 02.06			GAS	210386	110386.1	110386.2		516004
						211068	111068.0			
 (5m) 2.0i	(EV1)	09.03 - 02.06			GAS	210386	110386.1	110386.2		516004
						211068	111068.0			

CIVIC VIII















 excl. 	(FD)	09.05 - 09.12			GAS	210388	110388.1	110388.2		516004
						211466	111466.0			
 excl. Hybrid (prod. JAP)	(FD)	09.05 - 09.12			GAS	212099	112099.1	112099.2		516004
						212100	112100.0			
 excl. Hybrid (prod. GB, TR)	(FD)	09.05 - 09.12			GAS	212207	112207.1	112207.2		516004
										

CIVIC IX *NEW*





 excl. Type R	(FK)	02.12 -			GAS	212101	112101.1	112101.2		516004
						212102	112102.0			516010

HONDA (J)













CIVIC/BALLADE SHUTTLE II

 1.4, 1.5, 1.6 4X4 > Ch. S100001	(EE1, EE2, EE4)	01.88 - 12.88									516004
						GAS	210362	110362.0			516004
 1.4, 1.5, 1.6 4X4 Ch. S100002 > S200000	(EE1, EE2, EE4)	01.89 - 12.89				GAS	210360	110360.0			516004
						GAS	210361	110361.0			516004
 1.4, 1.5, 1.6 4X4 Ch. S200001 >	(EE1, EE2, EE4)	01.90 - 02.95				GAS	210360	110360.0			516004
						GAS	210362	110362.0			516004







CIVIC/BALLADE CRX I

 CRX 1.5, 1.6 excl. 1.6 DOHC	(AF, AS)	10.83 - 10.87				GAS	210355	110355.0			516004
						GAS	211059	111059.0			516010





CIVIC/BALLADE CRX II

 CRX 1.6i 16V > Ch. S100001	(ED9)	10.87 - 12.88				GAS	210356	110356.0			516004
						GAS	210357	110357.0			516004
CRX 1.4 Ch. S200001 > CRX 1.6 DOHC Ch. S10... >	(EE6) (EE6, EE8, ED9)	01.90 - 02.92 01.89 - 02.92				GAS	210358	110358.0			516004
						GAS	210359	110359.0			516004
CRX 1.6 SOHC Ch. S100002 >	(ED9)	01.89 - 02.92				GAS	210358	110358.0			516004
						GAS	210357	110357.0			516004











CIVIC/BALLADE CRX III

 CRX 1.6i ESI  CRX 1.6i Vti	(EH6)	03.92 - 12.98				GAS	210378	110378.1	110378.2			516004
	(EG2)					GAS	210363	110363.0			516004	





CONCERTO

	(HW)	08.89 - 03.95				GAS	210364	110364.1	110364.2			516004
						GAS	210365	110365.0			516004	





CR-V

	(RD)	10.95 - 07.02				GAS	211060	111060.0				
						GAS	211065	111065.0				
	(RD)	07.02 - 09.06				GAS	210387	110387.1	110387.2			516004
						GAS	211072	111072.0				

CR-V III

	(RE)	01.07 - 12.11				GAS	210392	110392.1	110392.2			516004
				excl. Xenon		GAS	211076	111076.0				

CR-V IV





 excl. 4WD	(RM)	10.12 -				GAS	210392	110392.1	110392.2			516004
						GAS	211077	111077.0				

FR-V *NEW*





	(BE1, BE3, BE5)	08.04 -		excl. Xenon		GAS	212215	112215.1	112215.2			516006
						GAS	212216	112216.0				

HONDA (J)















HR-V

 1.6 16V 4x2	(GH)	03.99 -				GAS	210381	110381.1	110381.2			516004
	(GH)	03.99 -				GAS	211463	111463.0				















INTEGRA/QUINT

	(AV, DA)	02.85 - 04.89				GAS	210366	110366.0				516004
						GAS	211059	111059.0				





JAZZ

	(GD)	03.02 - 04.05				GAS	210382	110382.1	110382.2			516004
						GAS	211464	111464.0				
	(GD)	04.05 - 07.08				GAS	210389	110389.1	110389.2			516004
						GAS	211464	111464.0				
	(GE)	07.08 -				GAS	210390	110390.1	110390.2			516004
						GAS	211467	111467.0				











LEGEND

 2.5	(HS)	01.86 - 1988				GAS	210367	110367.0				516004
						GAS	210672	110672.0				
 2.7	(KA4)	1989 - 12.90				GAS	210367	110367.0				516004
						GAS	210368	110368.0				
 2.7	(KA7)	01.91 - 02.96										516004
												











LOGO

 1.3	(GA3)	03.99 - 03.02				GAS	210380	110380.1	110380.2			516004
						GAS	211462	111462.0				





PASSPORT/JAZZ

	(AA)	01.94 - 12.97				GAS	211460	111460.0				
						GAS	211459	111459.0				
		01.98 - 12.02				GAS	211460	111460.0				
						GAS	211461	111461.0				





PRELUDE II/III

	(AB, BA1, BA2)	11.83 - 09.87				GAS	210369	110369.0				516004
						GAS	210347	110347.0				
 excl. 4 WS	(BA)	10.87 - 01.92				GAS	210370	110370.0				516004
						GAS	210371	110371.0				

PRELUDE IV

	(BB1, BB2, BB3)	02.92 - 09.96				GAS	210373	110373.0				516004
						GAS	210372	110372.0				





PRELUDE V

 excl. 2.2 Vti-S	(BB5, BB6, BB8, BB9)	10.96 - 10.00				GAS	211073	111073.1	111073.2			
						GAS	210372	110372.0				







HONDA (J)





QUINTET

	(SU, TU, TL, TS)	02.80 - 12.84			GAS	210353	110353.0			516004
						GAS	210354	110354.0		

SHUTTLE/ODYSSEY

	(RA1, RA3)	01.95 - 12.97			GAS	210379	110379.1	110379.2			516004
						GAS	210375	110375.0			516004





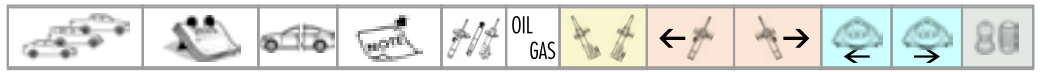



STREAM

	(RN1, RN3)	05.01 - 09.06			GAS	210383	110383.1	110383.2			516004
						GAS	211465	111465.0			









HYUNDAI (KO)



ACCENT/PONY/EXCEL

 1.2, 1.4		01.77 - 12.84			/	OIL	200024	100024.0			516004
							GAS	211468	111468.0		
 1.3, 1.6		10.85 - 08.89			/	GAS	210025	110025.0			516004
							GAS	211469	111469.0		
	(X2)	09.89 - 08.94			%	GAS	210394	110394.0			516004
							GAS	211469	111469.0		



ACCENT I

	(X3)	09.94 - 04.97			%	GAS	210397	110397.1	110397.2			516004
						24A	GAS	210400	110400.1	110400.2		
	(X3)	05.97 - 01.00			%	GAS	210397	110397.1	110397.2			516004
						24B	GAS	210407	110407.1	110407.2		



ACCENT II

	(LC)	01.00 - 10.05			%	GAS	210406	110406.1	110406.2			516004
						24B	GAS	210407	110407.1	110407.2		







ACCENT III

	(MC)	11.05 - 12.09			%	GAS	210414	110414.1	110414.2			516004
							GAS	211482	111482.0			516010



ACCENT IV

	(RB)	11.10 -			%	GAS	210918	110918.1	110918.2			516004
							GAS	211487	111487.0			-







ATOS/SANTRO

	(MX)	11.97 - 10.98		25A	%	GAS	210398	110398.1	110398.2			516004
							GAS	211471	111471.0			-
	(MX)	11.98 - 12.08		25B	%	GAS	210403	110403.1	110403.2			516004
							GAS	211471	111471.0			-



ATOS PRIME

	(MX)	11.98 - 12.08		25B	%	GAS	210403	110403.1	110403.2			516004
							GAS	211471	111471.0			-



COUPÉ

	(RD)	06.96 - 04.02			%	GAS	210399	110399.1	110399.2			516004
							GAS	210401	110401.1	110401.2	600261	600262
	(GK)	03.02 - 08.09			%	GAS	210404	110404.1	110404.2			516004
							GAS	210405	110405.1	110405.2	600261	600262

GALLOPER

	(JK-01)	08.98 - 12.03			-	GAS	211474	111474.0			
							GAS	211597	111597.0		

GETZ

	(TB)	08.02 - 12.10			%	GAS	210402	110402.1	110402.2			516004
							GAS	211476	111476.0			516010

HYUNDAI (KO)

H1/SATELLITE/STAREX

	(KMJ)	06.97 - 2007			♂	GAS	211472	111472.0			
					♀	GAS	211473	111473.0			
	(KMJ, KMF)	06.97 - 2007			♂	GAS	211472	111472.0			
					♀	GAS	211483	111483.0			-

H1

	Travel cargo	(TQ)	02.08 -			♂	GAS	212121	112121.1	112121.2			
						♀	GAS	212122	112122.0			-	

H100

	FD Series		07.93 - 10.04			♂	GAS	211489	111489.0			
						♀	GAS	211470	111470.0			-

i10

	(PA)	10.07 - 12.17			♂	GAS	210903	110903.1	110903.2			516004
					♀	GAS	211486	111486.0			-	

i10 II

	(BA, IA)	08.13 -			♂	GAS	212103	112103.1	112103.2			516004
					♀	GAS	212104	112104.0			516010	

i20

	(PB, PBT)	09.08 - 12.15			♂	GAS	210415	110415.1	110415.2			516004
					♀	GAS	211487	111487.0			-	

i20 II *NEW*

	(GB, IB)	11.14 -			♂	GAS	212105	112105.1	112105.2			516004
					♀	GAS	212106	112106.0			-	

i30

	O.E. 54651-2R100 / 54651-2R200 O.E. 54661-2R100 / 54661-2R200	(FD)	10.07 - 11.11			♂	GAS	210417	110417.1	110417.2			516004
						♀	GAS	211484	111484.0				
	O.E. 54651-2L100 / 54651-2L200 / 54651-2L600 O.E. 54661-2L100 / 54661-2L200 / 54661-2L600	(FD)	10.07 - 11.11			♂	GAS	210416	110416.1	110416.2			516004
						♀	GAS	211484	111484.0				
	CW	(FD)	10.07 - 06.12			♂	GAS	210416	110416.1	110416.2			516004
						♀	GAS	211484	111484.0				

i30 II

	excl. CW	(GD)	10.11 -			♂	GAS	212107	112107.1	112107.2			516004
						♀	GAS	211484	111484.0				





i30 III *NEW*

	(PDE, PD, PDEN)	11.16 -			♂	GAS	212226	112226.1	112226.2			
					♀	GAS	212227	112227.0				





i40

	excl. CW	(VF)	03.12 -			♂	GAS	210418	110418.1	110418.2			516004
						♀	GAS	211488	111488.0				











HYUNDAI (KO)

 CW	(VF)	07.11 -			GAS	210418	110418.1	110418.2			516004
					GAS	211488	111488.0				







ix20

	(JC)	11.10 -			GAS	212146	112146.1	112146.2			516004
					GAS	211487	111487.0				-





















ix35

 excl. 4WD	(LM, EL, ELH)	01.10 -			GAS	210916	110916.1	110916.2			516004
					GAS	212039	112039.0				
 4WD	(LM, EL, ELH)	01.10 -			GAS	210916	110916.1	110916.2			516004
					GAS	212040	112040.0				





KONA *NEW*

	(OS)	06.17 -			GAS	212226	112226.1	112226.2				
				2WD		GAS	212227	112227.0				
				4WD		GAS	212228	112228.0				





LANTRA/ELANTRA

	(J1)	12.90 - 09.95			GAS	210393	110393.0				516004
					GAS	211078	111078.0				
	(J2)	11.95 - 10.00 02.96 - 10.00			GAS	210399	110399.1	110399.2			516004
					GAS	210401	110401.1	110401.2	600261	600262	516004
	(XD)	06.00 - 07.06			GAS	210399	110399.1	110399.2			516004
					GAS	210411	110411.1	110411.2	600261	600262	516004
	(HD)	11.05 - 12.11			GAS	210416	110416.1	110416.2			516004
					GAS	211484	111484.0				





















MATRIX

	(FC)	06.01 - 08.10			GAS	210408	110408.1	110408.2			516004
					GAS	210409	110409.1	110409.2	600261	600262	516004





S COUPÉ

	(SLC)	09.89 - 05.96			GAS	210394	110394.0				516004
					GAS	211469	111469.0				-

SANTA FÉ



































	(SM)	02.01 - 03.06			GAS	210412	110412.1	110412.2			516004
					GAS	211480	111480.0				
	(CM)	03.06 - 06.09			GAS	210413	110413.1	110413.2			516004
					GAS	211481	111481.0				-
 *NEW*	(CM)	06.09 - 12.12			GAS	212176	112176.1	112176.2			516004
					GAS	211481	111481.0				-
 excl. 1.7 *NEW*	(DM, DMA)	09.12 -			GAS	212177	112177.1	112177.2			516004
											

SANTAMO





		10.98 - 12.02			GAS	210522	110522.0				516004
					GAS	211600	111600.0				

HYUNDAI (KO)





SONATA/SONICA

	(Y2)	10.88 - 04.93				GAS	210395	110395.0			516004
						GAS	211079	111079.0			
	(Y3)	05.93 - 06.98				GAS	210396	110396.0			516004
						GAS	211080	111080.0			
	(EF)	06.98 - 04.00				GAS	211081	111081.0			
				26A		GAS	211082	111082.0			
	(EF)	04.00 - 04.01				GAS	211081	111081.0			
				26B		GAS	211084	111084.0			
	(EF)	04.01 - 11.04				GAS	211085	111085.0			
				26B		GAS	211084	111084.0			
 2.4 GLS, 3.3 V6 GLS  2.0 CRDi GLS	(NF)	01.05 - 12.10				GAS	211087	111087.0			
		02.06 - 12.10				GAS	211485	111485.0			
 excl Hybrid	(YF)	01.09 - 12.15									
						GAS	211488	111488.0			











TERRACAN

	(HP)	05.01 - 12.06				GAS	211478	111478.0			
						GAS	211479	111479.0			







TRAJET

	(FO)	03.00 - 07.08				GAS	210410	110410.1	110410.2			516004
						GAS	211477	111477.0				

TUCSON

	(JM)	08.04 - 06.15				GAS	210907	110907.1	110907.2			516004
						GAS	210908	110908.1	110908.2	600261	600262	516004
 excl. 1 st	(TL, TLE)	06.15 -				GAS	212172	112172.1	112172.2			516007
						GAS	212173	112173.0				516001



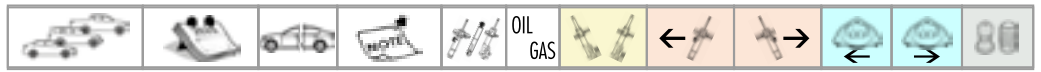

XG

	(XG)	12.98 - 12.05				GAS	211081	111081.0			
				26A		GAS	211082	111082.0			
				26B		GAS	211084	111084.0			







INFINITI (J)

Q30 *NEW*





		11.15-				GAS	210517	110517.1	110517.2			
						GAS	211592		111592.0			

INNOCENTI (I)





ELBA

	(146)	04.86 - 12.96				OIL	200253	100253.0			
						OIL	200268	100268.0			





KORAL

		01.90 - 12.92				OIL	200804	100804.0			
						OIL	200244	100244.0			





MILLE

		1994 - 1995				OIL	200421	100421.0			
						OIL	200422	100422.0			

MINI, 90, 120

Mini 1001, 1300 90, 120, De Tomaso		1974 - 1982				OIL	201271	101271.0			
		1974 - 1982				OIL	201273	101273.0			

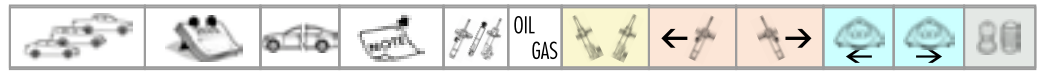

MINI 3 CILINDRI

		05.74 - 01.95				OIL	200419	100419.0			
						OIL	200420	100420.0			





ISUZU (J)











GEMINI

PF 50, PF 60		1974 - 1979			⊖	OIL	201661	101661.0			
					⊖	OIL	201675	101675.0			













PIAZZA

JR 130		1981 - 1982			⊖	OIL	201661	101661.0			
					⊖	GAS	211674	111674.0			

PICK-UP















KB 2, KBD 2 (4X2)		1980 - 07.86			⊖	GAS	211489	111489.0			
					⊗	GAS	211596	111596.0			
KB 2, KBD 2 (4X2)		08.86 -			⊖						
					⊗	GAS	211596	111596.0			
KB 4, KBD 4 (4X4)		1980 -			⊖	GAS	211489	111489.0			
					⊗	GAS	211490	111490.0			
TFR Series CAMPO/BRAVA (4X2)		1988 -			⊖						
					⊗						
TFS Series CAMPO/BRAVA (4X4)		1988 -			⊖	GAS	211670	111670.0			
					⊗	GAS	211490	111490.0			

TROOPER / BIG HORN







4X4	(UBS)	1983 - 10.86			⊖	GAS	211489	111489.0			
					⊗	GAS	211490	111490.0			
4X4 excl. v	(UBS)	11.86 - 1991			⊖	GAS	211670	111670.0			
					⊖	GAS	211459	111459.0			
	(UB)	08.91 - 07.98			⊖	GAS	211670	111670.0			
					⊗	GAS	211680	111680.0			
2m		1996 -			⊖	GAS	211688	111688.0			
					⊗	GAS	211680	111680.0			
4m		1996 -			⊖	GAS	211688	111688.0			
					⊗	GAS	211680	111680.0			
4X4 excl. v	(UBS)	02.98 -			⊖	GAS	211493	111493.0			
					⊗	GAS	212001	112001.0			

IVECO (I)



DAILY, TURBO DAILY

28F8/U8 30.8 > Ch. 304675 35.8, 35.9, 35.10 40.8, A 40.8, 40.10, A 40.10	01.78 - 08.89 01.78 - 08.89 01.78 - 08.89 01.78 - 08.89		27A	⊗	OIL	201393	101393.0			-
			27B	⊗	OIL	201394	101394.0			-
30.8 Ch. 304676 >	01.78 - 08.89		N.D. 27C	⊗	OIL	201406	101406.0			-
			H.D. 27C	⊗	OIL	202021	102021.0			-
			27B	⊗	OIL	201394	101394.0			-
30.8, 30.9 New Daily 35.8, 35.10, 35.12 New Daily 40.8, A 40.8 New Daily	09.89 - 04.99 09.89 - 04.99 09.89 - 04.99		N.D. 27C	⊗	OIL	201406	101406.0			-
			H.D. 27C	⊗	OIL	202021	102021.0			-
			27E	⊗	OIL	201408	101408.0			-
			27D	⊗	OIL	201287	101287.0			-
35.8 CB 5, 40.8, A 40.8	08.89 - 04.99		N.D. 27D	⊗	OIL	201287	101287.0			-
			H.D. 27D	⊗	OIL	202022	102022.0			-
			27B	⊗	OIL	201394	101394.0			-
35.10 V, 45.10, A 45.10	08.89 - 04.99		N.D. 27D	⊗	OIL	201287	101287.0			-
			H.D. 27D	⊗	OIL	202022	102022.0			-
			27E	⊗	OIL	201408	101408.0			-
45.10, A 45.10, 49.10 New Turbo Daily	09.89 - 04.99 09.89 - 04.99		N.D. 27D	⊗	OIL	201287	101287.0			-
			H.D. 27D	⊗	OIL	202022	102022.0			-
			27D	⊗	OIL	201287	101287.0			-
49.10, 49.12	09.89 - 04.99		N.D. 27D	⊗	OIL	201287	101287.0			-
			H.D. 27D	⊗	OIL	202022	102022.0			-
			27E	⊗	OIL	201408	101408.0			-
40 NC 35	08.89 - 04.99		27B	⊗	OIL	201394	101394.0			-
			27A	⊗	OIL	201393	101393.0			-

DAILY S2000

35S9, 35S11, 35S13, 35S15	05.99 - 05.06		27F	⊗	OIL	201286	101286.0			-
			N.D. 27H	⊗	OIL	201288	101288.0			-
			H.D. 27H	⊗	OIL	202023	102023.0			-
35C9, 35C11, 35C13, 35C15	05.99 - 05.06		27F	⊗	OIL	201286	101286.0			-
			27G	⊗	OIL	201287	101287.0			-
			N.D. 27H	⊗	OIL	201288	101288.0			-
			H.D. 27H	⊗	OIL	202023	102023.0			-
			27G	⊗	OIL	201287	101287.0			-
50C11, 50C13, 50C15	05.99 - 05.06		N.D. 27H	⊗	OIL	201288	101288.0			-
			H.D. 27H	⊗	OIL	202023	102023.0			-
			27G	⊗	OIL	201287	101287.0			-



MASSIF

	10.08 - 02.11			⊗	OIL	201309	101309.0			-
				⊗	GAS	211310	111310.0			





JAGUAR (GB)



S TYPE

	(X200)	01.99 - 12.08			∅	GAS	211089	111089.0			
					∅	GAS	211090	111090.0			

X TYPE





	(X400)	01.01 - 11.09			∅	GAS	210423	110423.0			
					∅	GAS	211495	111495.0			-

XJ SERIES









XJ-6 Daimler Sovereign XJ-12, Sovereign V12 Daimler Double Six XJS, XJSC		1968 - 1986			∅	GAS	211494	111494.0			
		1969 - 1984			∅	GAS	211088	111088.0			
		1972 - 02.93									
		1972 - 02.93		28	∅	GAS	211088	111088.0			
		1975 - 02.93									











JEEP (USA)

Trailhawk rialzato +5cm	(BU, B1)	07.14 -				GAS	212149	112149.1	112149.2			516004
							GAS	212150	112150.1	112150.2		

WAGONEER



(XJ) excl. Grand Wagoneer	(XJ)	1984 - 1995				GAS	211770	111770.0			
							GAS	211771	111771.0		
Grand Wagoneer (SJ)	(SJ)	1984 - 1990									-
											

WRANGLER/LAREDO









Wrangler, Laredo (YJ)	(YJ, SJ)	08.86 - 08.96				GAS	211768	111768.0			
							GAS	211769	111769.0		
Wrangler, Laredo (TJ)	(TJ)	08.96 - 04.07				GAS	211770	111770.0			
											

KIA (KO)









BESTA

	(TB)	02.96 - 12.03			±	GAS	212026	112026.0			
					∅	GAS	212027	112027.0			









CARENS

	(FC)	11.00 - 10.02				GAS	210899	110899.1	110899.2			516004
						GAS	210900	110900.1	110900.2			516004
 excl. 03.13 03.14	(UN)	09.06 -				GAS	210910	110910.1	110910.2			516004
					±	GAS	212034	112034.0				





CARNIVAL/SEDONA

	(UP, GQ)	08.99 - 05.06				GAS	210893	110893.1	110893.2			516004
					±	GAS	212028	112028.0				
	(VQ)	06.06 -				GAS	210909	110909.1	110909.2			516004
					∅	GAS	212033	112033.0				





CEE'D

	(ED)	12.06 - 12.12				GAS	210913	110913.1	110913.2			516004
					±	GAS	211484	111484.0				
	(JD)	09.12 -				GAS	212107	112107.1	112107.2			516004
					±	GAS	211484	111484.0				





CERATO

	(LD)	03.04 -				GAS	210914	110914.1	110914.2			516004
						GAS	210915	110915.1	110915.2			516004









CLARUS/CREDOS

	(K9A)	07.96 - 11.01				GAS	210901	110901.1	110901.2			516004
	(GC)		05.98 -				GAS	210902	110902.1	110902.2		





JOICE

	(M300E)	02.00 -				GAS	210522	110522.0			
					∅	GAS	211600	111600.0			





MAGENTIS

	(GD, MS)	05.01 -				GAS	211081	111081.0				
						GAS	211084	111084.0				
	(MG)	11.05 -				GAS	210910	110910.1	110910.2			
					±	GAS	212034	112034.0				

NIRO *NEW*

 1.6 GDI Hybrid		09.16 -				GAS	212174	112174.1	112174.2			516004
					∅	GAS	212175	112175.0			516010	





PICANTO

	(SA)	04.04 -				GAS	210903	110903.1	110903.2			516004
					∅	GAS	212029	112029.0			516010	







KIA (KO)





PICANTO II

	(TA)	05.11 -			GAS	210917	110917.1	110917.2			516004
						GAS	212038	112038.0			





PICANTO III

	(JA)	03.17 -			GAS	212229	112229.1	112229.2			
						GAS	212029	112029.0			









PREGIO

	(TB)	10.97 -			GAS	210906	110906.1	110906.2			516010
						GAS	212030	112030.0			









PRIDE

	(DA)	10.96 -12.11			OIL	200494	100494.1	100494.2			516004
						GAS	211094	111094.0			





PRO CEE'D

	(ED)	02.08 -09.12			GAS	210913	110913.1	110913.2			516004
						GAS	211484	111484.0			
	(JD)	03.13 -			GAS	212107	112107.1	112107.2			516004
						GAS	211484	111484.0			





RIO

	(DC)	08.00 -07.02			GAS	210896	110896.1	110896.2			516004
						GAS	212025	112025.0			
	(DC)	07.02 -05.05			GAS	210911	110911.1	110911.2			516004
						GAS	212035	112035.0			





RIO II

	(JB)	03.05 -			GAS	210912	110912.1	110912.2			516004
						GAS	212036	112036.0			





RIO III

	(UB)	09.11 -			GAS	210918	110918.1	110918.2			516004
						GAS	211487	111487.0			





RIO IV

	(YB, SC, FB)	01.17 -			GAS	212230	112230.1	112230.2			
						GAS	212231	112231.0			

SEPHIA

	ABS	(FA)	09.93 -12.97			OIL	200897	100897.1	100897.2			
							OIL	200898	100898.1	100898.2		

SHUMA

	(FB)	10.97 -12.98			GAS	210894	110894.1	110894.2			
						GAS	210895	110895.1	110895.2		

KIA (KO)

	(FB)	01.99 - 04.01				GAS	210899	110899.1	110899.2			
						GAS	210895	110895.1	110895.2			
	(FB)	05.01 - 05.04				GAS	210904	110904.1	110904.2			
						GAS	210905	110905.1	110905.2			

SORENTO

	(JC)	08.02 -				GAS	211212	111212.1	111212.2			
						GAS	212031	112031.0				-
3.3 V6, 2.5 CRDi 125 Kw	(JC)	12.06 -				GAS	211212	111212.1	111212.2			
						GAS	212037	112037.0				

SORENTO II

excl. ₺	(XM)	11.09 - 09.12				GAS	212176	112176.1	112176.2			516004
						GAS	211481	111481.0				-
excl. ₺	(XM)	09.12 -				GAS	212177	112177.1	112177.2			516004

SORENTO III *NEW*

excl. ₺	(UM)	01.15 -				GAS	212202	112202.1	112202.2			516007
						GAS	212203	112203.0				516001

SOUL I *NEW*

	(AM)	02.09 -										

SOUL II *NEW*

	(PS)	02.14 -										

SPORTAGE

	(KOO)	09.94 - 12.98				GAS	211210	111210.0				
						GAS	212024	112024.0				
	(KOO)	01.99 - 08.04				GAS	210906	110906.1	110906.2			
						GAS	212032	112032.0				
	(JE, KM)	09.04 -				GAS	210907	110907.1	110907.2			
						GAS	210908	110908.1	110908.2	600261	600262	
excl. AWD	(SL)	07.10 - 12.15				GAS	210916	110916.1	110916.2			
						GAS	212039	112039.0				
AWD	(SL)	07.10 - 12.15				GAS	210916	110916.1	110916.2			516004
						GAS	212040	112040.0				516010
excl. ₺ *NEW*	(QL, QLE)	09.15 -				GAS	212172	112172.1	112172.2			516007
						GAS	212173	112173.0				516001

STONIC *NEW*

	(YB)	07.17				GAS	212230	112230.1	112230.2			
						GAS	212232	112232.0				





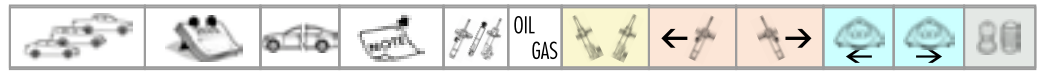

VENGA *NEW*

	(YN)	02.10 -				GAS	212146	112146.1	112146.2			516004
						GAS	211487	111487.0				-





LADA (RU)



110/111/112

	(2110, 2111, 2112)	01.95 - 03.04			/	GAS	210027	110027.0			
							∞	GAS	211092	111092.0	
	(2110, 2111, 2112)	03.04 - 12.12			∞						
							∞	GAS	211092	111092.0	



DIVA, FORMA, SAGONA

	(2109, 21099)	09.87 - 12.06			/	OIL	200026	100026.0			
							∞	OIL	201091	101091.0	



KALINKA/NOVA

	(2104, 2105, 2108, 2109)	05.81 - 04.12			∞	OIL	201496	101496.0			
							∞	OIL	201497	101497.0	







NIVA

	(2121, 2131)	12.76 -			∞	GAS	211498	111498.0			
							∞	GAS	211499	111499.0	



NIVA II

	(2123)	09.02 -			∞						
							∞				

SAMARA/NATACHA

	(2108, 2109)	01.86 -			/	OIL	200026	100026.0			
							∞	OIL	201091	101091.0	
	(2108, 2109)	01.03 -			∞						
							∞	OIL	201091	101091.0	

VAZ (1200 - 1600)

	(2101, 2102, 2103, 2104, 2105, 2106, 2107, 21011, 21061)	01.70 - 12.05			∞	OIL	201496	101496.0			
							∞	OIL	201497	101497.0	

LANCIA (I)

DEDRA

excl. 4X4	(835)	01.89 - 12.97				GAS	210259	110259.0	600751	600752	516004
						GAS	211404	111404.0			-
excl. 4X4	(835)	01.98 - 07.99				GAS	210281	110281.0	600690		516004
						GAS	211404	111404.0			-
4X4	(835)	09.94 - 12.97				GAS	210259	110259.0	600751	600752	516004
4X4	(835)	01.98 - 07.99				GAS	210281	110281.0	600690		516004

DELTA I

1.3, 1.5	(831ABO)	09.79 - 02.83				GAS	210424	110424.0			516004
						GAS	210426	110426.1 110426.2			516004
1.3, 1.5 1.6 GT, 1.6 HF Turbo	(831ABO)	02.83 - 01.86 02.83 - 01.86				GAS	210424	110424.0			516004
						GAS	210426	110426.1 110426.2			516004
1.3, 1.5, 1.9 D, 1.9 TD excl. 4X4 1.6, 1.6 GTie, 1.6 HF Turbo excl. 4X4	(831ABO)	02.86 - 01.94 02.86 - 01.94				GAS	210425	110425.0			516004
						GAS	210427	110427.1 110427.2			516004
2.0 HF 8V Integrale 4X4 2.0 HF 16V Integrale 4X4	(831ABO)	02.86 - 01.94 1987 - 01.94				GAS	210428	110428.0			516004
						GAS	210429	110429.0			516004
2.0 HF Integrale Evoluzione	(831ABO)	06.91 - 01.94				GAS	210430	110430.0			516004
						GAS	210431	110431.0			516004

DELTA II

1.4, 1.6	(836)	06.93 - 08.99				GAS	210441	110441.0	600751	600752	516004
						GAS	211404	111404.0			-
1.8, 2.0 16V	(836)	06.93 - 08.99				GAS	210259	110259.0	600751	600752	516004
						GAS	211404	111404.0			-
1.9 TD	(836)	10.94 - 08.99				GAS	210441	110441.0	600751	600752	516004
						GAS	211404	111404.0			-
2.0 Turbo 16V excl. 16	(836)	06.93 - 08.99				GAS	210432	110432.0	600751	600752	516004
						GAS	211404	111404.0			-

DELTA III

excl. 1.9 D Multijet	(844)	09.08 - 08.14		13A		GAS	210163	110163.0	600560		516004
						GAS	211298	111298.0			516010
1.9 D Multijet	(844)	09.08 - 08.14		13B		GAS	210175	110175.0	600560		516004
						GAS	211298	111298.0			516010

FLAVIA

		1962 - 1970				GAS	211508	111508.0			-
						GAS	211509	111509.0			-

FULVIA

		1963 - 1970				GAS	211506	111506.0			516004
						GAS	211507	111507.0			-
		1963 - 1971				GAS	211506	111506.0			516004
						GAS	211507	111507.0			-
		1961 - 1975				GAS	211508	111508.0			-
						GAS	211509	111509.0			-

LANCIA (I)

KAPPA

2.0, 3.0 V6, 2.4 TDS, 2.4 JTD > Ch. 2050295	(838A)	10.94 - 10.01			GAS	210433	110433.0			516004
					GAS	210435	110435.0			516004
2.0, 3.0, 2.4 TD, 2.4 JTD Ch. 2050296 > 2087505	(838A)	10.94 - 10.01			GAS	210434	110434.0			516004
					GAS	210435	110435.0			516004
2.0, 3.0 V6, 2.4 TDS, 2.4 JTD Ch. 2087506 >	(838A)	10.94 - 10.01			GAS	210434	110434.0			516004
					GAS	210444	110444.0			516004
2.4, 2.0 Turbo > Ch. 2087505	(838A)	10.94 - 10.01			GAS	210433	110433.0			516004
					GAS	210435	110435.0			516004
2.4, 2.0 Turbo Ch. 2087506 >	(838A)	10.94 - 10.01			GAS	210433	110433.0			516004
					GAS	210444	110444.0			516004
excl. ☞	(838B)	07.96 - 10.01			GAS	210433	110433.0			516004
2.0, 3.0 V6, 2.4 TDS, 2.4 JTD	(838)	07.96 - 10.01			GAS	210434	110434.0			516004
					GAS	210445	110445.0			516004
2.4, 2.0 Turbo	(838)	07.96 - 10.01			GAS	210433	110433.0			516004
					GAS	210445	110445.0			516004

LYBRA

1.6, 1.8 excl. ☞	(839AX)	07.99 - 10.05		13A		GAS	210442	110442.0	600660	516004
						GAS	211501	111501.0		516010
2.0, 1.9 JTD, 2.4 JTD	(839AX)	07.99 - 10.05		13B		GAS	210443	110443.0	600660	516004
						GAS	211501	111501.0		516010
1.6, 1.8 excl. ☞	(839BX)	07.99 - 10.05		13A		GAS	210442	110442.0	600660	516004
						GAS	211501	111501.0		516010
2.0, 1.9 JTD, 2.4 JTD	(839BX)	07.99 - 10.05		13B		GAS	210443	110443.0	600660	516004
						GAS	211501	111501.0		516010

MUSA

1.4i	(350)	10.04 - 09.12				GAS	210164	110164.0	600130	516004
						GAS	211290	111290.0		-
1.3 JTD, 1.9 JTD	(350)	10.04 - 09.12				GAS	210153	110153.0	600130	516004
						GAS	211290	111290.0		-

PHEDRA

	(179)	09.02 - 11.10				GAS	210447	110447.1	110447.2	600741	600742	516004
						GAS	211289	111289.0				-

PRISMA







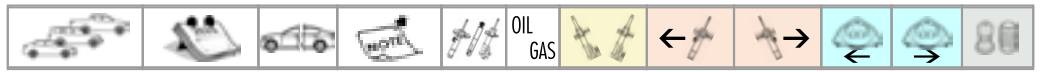









1.3, 1.5, 1.6 1.9 D, 1.9 TD	(831AB0)	02.83 - 01.86 02.83 - 01.86				GAS	210424	110424.0			
						GAS	210426	110426.1	110426.2		
1.3, 1.5, 1.6 excl. 4X4 1.9 D, 1.9 TD excl. 4X4	(831AB0)	02.86 - 02.92 02.86 - 02.92				GAS	210425	110425.0			
						GAS	210427	110427.1	110427.2		
2.0 8V Integrale	(831AB0)	02.86 - 02.92				GAS	210428	110428.0			
						GAS	210429	110429.0			

THEMA





> Ch. 29408 excl. 3.0 V8 8.32, ☞	(834)	11.84 - 10.86				GAS	210251	110251.0			516004
						GAS	210250	110250.0			516004

























LANCIA (I)

Ch. 29409 >  excl. 3.0 V8 8.32, 	(834)	11.86 - 07.94			GAS	210251	110251.0			516004
					GAS	210106	110106.0			516004
Ch. 29409 >  excl. 3.0 V8 8.32, 	(834)	11.86 - 07.94			GAS	210251	110251.0			516004
					GAS	210106	110106.0			516004
3.0 V6 CRD, 3.6 V6 VVT	(LX)	09.11 - 10.14			GAS	210450	110450.0			516004
					GAS	211505	111505.0			-









VOYAGER

MPV, Space Wagon	(404)	09.11 - 12.14			GAS	210450	110450.0			516004
					GAS	211505	111505.0			-





Y 10

4X2	(156)	03.85 - 1992			OIL	200135	100135.1	100135.2			516004
					GAS	210135	110135.1	110135.2			
					OIL	201274	101274.0				-
					GAS	211274	111274.0				-
4X2	(156)	1993 - 12.95			OIL	200135	100135.1	100135.2			516004
					GAS	210135	110135.1	110135.2			
					OIL	201276	101276.0				-
					GAS	211276	111276.0				-
4X4	(156)	12.86 - 1992			OIL	200135	100135.1	100135.2			516004
					GAS	210135	110135.1	110135.2			
					OIL	201275	101275.0				-
					GAS	211275	111275.0				-
4X4	(156)	1993 - 12.95			OIL	200135	100135.1	100135.2			516004
					GAS	210135	110135.1	110135.2			
					GAS	211277	111277.0				-









Y

excl. Elefantino Blu	(840A)	11.95 - 09.03			GAS	210436	110436.0	600520		516004
					GAS	211397	111397.0			-
Elefantino Blu	(840A)	11.95 - 09.03			GAS	210262	110262.0	600520		516004
					GAS	211397	111397.0			-











YPSILON

	(843)	10.03 - 12.11			GAS	210164	110164.0	600130		516004
					GAS	211290	111290.0			-

YPSILON II



excl. Metano, TwinAir	(312)	05.11 -			GAS	210449	110449.1	110449.2	600500	516004
					GAS	211504	111504.0			-
Metano, TwinAir	(312)	05.11 -			GAS	210887	110887.1	110887.2		
					GAS	212178	112178.0			-

ZETA



	(834)	03.94 - 12.97			GAS	210270	110270.0	600741	600742	516004
				18A		GAS	211401	111401.0		
	(834)	01.98 - 09.02			GAS	210270	110270.0	600741	600742	516004
				18B		GAS	211351	111351.0		

LAND ROVER (GB)



88/109 SERIES

x= 86" x= 88" I, II, IIA, IIB, III series x= 107" x= 109" I series		01.53 - 06.56			⊕	GAS	211510	111510.0				-
		01.56 - 12.83			⊖							
x= 109" II, IIA, IIB, III series x= 119"		01.53 - 11.58			⊕	GAS	211248	111248.0				-
		01.53 - 02.58			⊖							
x= 109" II, IIA, IIB, III series x= 119"		01.58 - 12.84			⊕	GAS	211510	111510.0				-
		01.58 - 12.84			⊖							





90/110 SERIES

		09.83 - 07.90			+	GAS	211512	111512.0				
					-							
					-	GAS	211513	111513.0				





DEFENDER

	(L316)	08.90 - 02.16			+	GAS	211512	111512.0				
					-							
					-	GAS	211513	111513.0				





DISCOVERY I

 > Ch. MA135957	(LJ)	09.89 - 06.94			+	GAS	211512	111512.0				
					-							
 Ch. MA135958 >	(LJ)	06.94 - 12.98			+	GAS	211512	111512.0				
					-							
					-	GAS	211516	111516.0				



DISCOVERY II

 excl. □, Active roll	(L318)	11.98 - 06.04			⊖	GAS	211520	111520.0				
					⊕							
 □ excl. Active roll	(L318)	11.98 - 06.04			⊖	GAS	211520	111520.0				
					⊕							
					⊖	GAS	211522	111522.0				









FREELANDER

	(LN)	02.98 - 10.00			⚡	GAS	210451	110451.1	110451.2			
					⚡							
	(LN)	10.00 - 10.06			⚡	GAS	210452	110452.1	110452.2			
					⚡							
					⚡	GAS	210453	110453.1	110453.2			
					⚡	GAS	210452	110452.1	110452.2			

FREELANDER II



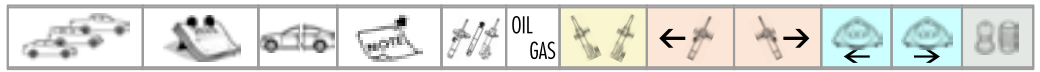

 excl. □, ⚡	(LF, FA)	10.06 - 10.14			⚡	GAS	210454	110454.1	110454.2			
					⚡							
					⚡	GAS	210455	110455.1	110455.2			

RANGE ROVER





x= 100" excl. □	(LH)	06.70 - 07.94			+	GAS	211512	111512.0				
					-							
 □	(LH)	10.92 - 07.94			+	GAS	211517	111517.0				
					-							
 Classic excl. □	(LH)	07.94 - 02.96			+	GAS	211512	111512.0				
					-							
 Classic □	(LH)	07.94 - 02.96			+	GAS	211517	111517.0				
					-							
 □ excl. Classic	(LP)	09.94 - 03.02			⊖	GAS	211518	111518.0				
					⊕							
					⊖	GAS	211519	111519.0				











LAND ROVER (GB)

	(LM)	03.02 - 08.12	 										
Sport	(L320)	02.05 - 03.13	 										

RANGE ROVER EVOQUE *NEW*

 excl. €	(L538)	06.11 -	 		 	GAS	212179	112179.1	112179.2				516004
						GAS	212180	112180.1	112180.2				516004





SANTANA

x= 88" 2.5 DC, 2500 DC		01.58 - 12.89	 		 	GAS	211510	111510.0					-
						GAS	211248	111248.0					-
x= 109", 119" 2.5DL/DE, 3.5DL, 2500DL, 3500DL		01.58 - 12.89	 		 	GAS	211510	111510.0					-
						GAS	211511	111511.0					-







LEXUS (J)

NX *NEW*

 □	(Z1)	07.14 -				GAS	210865	110865.1	110865.2			516004
						GAS	211995	111995.0			-	



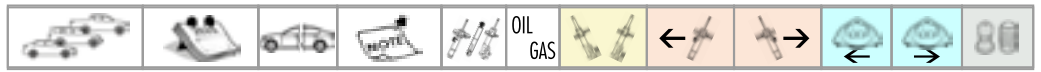

RX *NEW*

300, 350 excl. □	(U3)	05.03 - 12.08				GAS	212181	112181.1	112181.2			516004
						GAS	212182	112182.1	112182.2			516004







MAZDA (J)





















121/REVUE I

	(DA)	10.87 - 02.91				OIL	200494	100494.1	100494.2			516004
						GAS	211094	111094.0				











121/REVUE II

	(DB)	03.91 - 03.96				GAS	210468	110468.0				516004
						GAS	211095	111095.0				





121/REVUE III

	(JASM, JBSM)	08.95 - 09.98		21D		GAS	210313	110313.0		600310		516004
						GAS	211054	111054.0		600360		
	(JASM, JBSM)	10.98 - 04.03		21E		GAS	210313	110313.0		600310		516004
						GAS	211057	111057.0		600360		
	(JASM, JBSM)	10.98 - 04.03		21D		GAS	210313	110313.0		600310		516004
						GAS	211054	111054.0		600360		
	(JASM, JBSM)	08.95 - 09.98		21D		GAS	210316	110316.0		600310		516004
						GAS	211054	111054.0		600360		
	(JASM, JBSM)	10.98 - 04.03		21E		GAS	210316	110316.0		600310		516004
						GAS	211057	111057.0		600360		





2

	(DY)	01.03 - 12.03		22A		GAS	210330	110330.1	110330.2	600340		516004
								GAS	211442	111442.0		600460
	(DY)	01.04 - 12.09		22B		GAS	210487	110487.1	110487.2	600340		516004
								GAS	211442	111442.0		600460





2 II

	(DE)	10.07 - 06.15				GAS	210965	110965.1	110965.2			516004
								GAS	212081	112081.0		





2 III *NEW*

	(DL, DJ)	08.14 -				GAS	212183	112183.1	112183.2			516004
								GAS	212184	112184.0		





3

	(BK)	10.03 - 06.09				GAS	210488	110488.1	110488.2	600480		516004
								GAS	211528	111528.0		600400





3 II

	(BL)	12.08 - 09.14				GAS	210488	110488.1	110488.2	600480		516004
								GAS	211528	111528.0		600400

3 III

	(BM, BN)	07.13 -				GAS	212108	112108.1	112108.2			516004
								GAS	212109	112109.0		

323 II

	(BD)	06.80 - 10.89				GAS	210456	110456.0				516004
								GAS	210457	110457.0		

MAZDA (J)

323 III

1.1, 1.3, 1.4, 1.5, 1.6, 1.7 D excl. 4X4, †	(BF)	01.85 - 05.89			GAS	210456	110456.0			516004
					GAS	210457	110457.0			516004
excl. 4X4, †	(BW12)	11.85 - 10.95			GAS	210456	110456.0			516004

323 IV

323 C, 323 S excl. 4X4, †	(BF)	06.89 - 08.94			GAS	210458	110458.1	110458.2		516004
					GAS	210459	110459.1	110459.2		516004
323 F 1.6, 1.8 excl. 4X4, †	(BG)	06.89 - 08.94			GAS	210458	110458.1	110458.2		516004
					GAS	210459	110459.1	110459.2		516004

323 V

1.3, 1.5, 1.7 TD, 1.8, 2.0 D 323 F 1.3, 1.5, 1.8	(BA)	09.94 - 09.98			GAS	210471	110471.1	110471.2		516004
	(BA)	09.94 - 09.98			GAS	210472	110472.1	110472.2		516004

323 VI

1.3, 1.5, 1.8, 2.0 D, 2.0 TD > Ch. 304194	(BJ)	09.98 - 12.99			GAS	210481	110481.1	110481.2		516004
					GAS	210482	110482.1	110482.2		516004
1.3, 1.5, 1.8, 2.0 D, 2.0 TD Ch. 304195 > 400000	(BJ)	01.00 - 11.00			GAS	210483	110483.1	110483.2		516004
					GAS	210482	110482.1	110482.2		516004
1.3, 1.5, 1.8, 2.0 D, 2.0 TD Ch. 400001 >	(BJ)	12.00 - 05.04			GAS	210483	110483.1	110483.2		516004
					GAS	210484	110484.1	110484.2		516004

5

	(CR)	03.05 - 05.10			GAS	210489	110489.1	110489.2	600480	516004
					GAS	211531	111531.0	600400	516010	

5 II

	(CW)	09.10 -			GAS	210489	110489.1	110489.2	600480	516004
					GAS	211531	111531.0	600400	516010	

6

excl. † excl. †, 4X4	(GG)	06.02 - 12.08			GAS	211100	111100.1	111100.2		
	(GY)	08.02 - 12.07			GAS	211529	111529.0			-
4X4 excl. †	(GY)	06.02 - 12.07			GAS	211101	111101.1	111101.2		
4x2	(GH)	08.07 - 07.13			GAS	210963	110963.1	110963.2		
					GAS	212079	112079.0			-
4x4	(GH)	08.07 - 07.13			GAS	210964	110964.1	110964.2		
					GAS	212080	112080.0			-

626 II

excl. †	(GC)	11.82 - 05.87			GAS	210460	110460.0			516004
					GAS	210461	110461.0			516004

626 III

, excl. 4WS, †	(GD)	05.87 - 12.91			GAS	210462	110462.0			516004
					GAS	210463	110463.0			516004

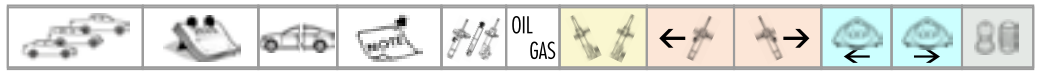

MAZDA (J)

excl. 4X4, 4WS	(GV)	03.88 - 09.97				GAS	210462	110462.0			516004

626 IV

excl. 4X4, 4WS	(GE)	08.91 - 04.97				GAS	210464	110464.1	110464.2		516004

626 V

excl. 4X4, 4WS	(GF)	04.97 - 07.99				GAS	210475	110475.1	110475.2		516004
excl. 4X4, 4WS	(GW)	04.97 - 07.99				GAS	210475	110475.1	110475.2		516004
excl. 4X4, 4WS	(GF)	08.99 - 10.02				GAS	210477	110477.1	110477.2		516004
excl. 4X4, 4WS	(GW)	08.99 - 10.02				GAS	210477	110477.1	110477.2		516004

929 III

excl. 3.0 V6, 4WS	(HC)	09.86 - 05.89				GAS	210466	110466.0			516004
excl. 4WS	(HC)	06.89 - 06.91				GAS	210467	110467.0			516004

B SERIES

1.6, 1.8, 2.0	(BNA)	01.70 - 08.85				OIL	201673	101673.0			
1600, 2000, 2200 excl. 4X4	(UF)	01.85 - 06.99 01.85 - 06.99				GAS	211670	111670.0			516004

CX-3 *NEW*

	(DK)	02.15 -				GAS	212185	112185.1	112185.2		516004

CX-5

excl. ALKS01	(KE, GH)	11.11 - 02.17				GAS	210966	110966.1	110966.2		516004

CX-5 II *NEW*

	(KF)	05.17 -				GAS	212233	112233.1	112233.2		

DEMIO









	(DW)	08.98 - 12.99				GAS	210491	110491.1	110491.2		516004
	(DW)	01.00 - 12.02				GAS	210491	110491.1	110491.2		516004

E SERIES













E 1600		01.78 - 06.84				OIL	201673	101673.0			







MAZDA (J)

E 2200		01.78 - 06.84			±	OIL	201673	101673.0			
					∞	OIL	201377	101377.0			-
E 1400, 1800 H	(SR1, SR2)	01.84 - 12.97			±						
					∞	GAS	211625	111625.0			-
E 2000, 2200 H excl. 4X4		01.84 - 12.97									
											
E 1400, 1800 H-H excl. 4X4 E 2000, 2200 H-H excl. 4X4	(SR1, SR2)	01.84 - 12.97			±						
		01.84 - 12.97			∞	OIL	201377	101377.0			-









MPV

excl. 4X4	(LV52, LV12)	11.88 - 09.99				GAS	210469	110469.0			516004
					∞	GAS	211526	111526.0			-
4X4	(LV52, LV12)	11.88 - 09.99				GAS	210469	110469.0			516004
					∞	GAS	211526	111526.0			-
excl. 4X4	(LW)	09.99 - 03.02									516004
					∞						-
excl. 4X4	(LW)	03.02 - 02.06									516004
					∞						-











MX-3

	(EC)	07.91 - 05.98									516004
											516004











MX-5/MIATA

excl. ABS	(NA)	09.89 - 04.98				GAS	211096	111096.0			
						GAS	211097	111097.0			
ABS	(NA)	09.89 - 04.98									
						GAS	211097	111097.0			

MX-6

excl. 4WS, 	(GE1)	07.91 - 09.97				GAS	210464	110464.1	110464.2			516004
						GAS	210465	110465.0			516004	
2.5 4WS excl. 	(GE7)	07.91 - 09.97				GAS	210464	110464.1	110464.2			516004
											516004	





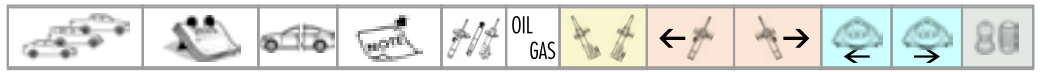









PREMACY

	(CP)	07.99 - 06.01				GAS	210485	110485.1	110485.2			516004
						GAS	210486	110486.1	110486.2			516004
	(CP)	07.01 - 03.05				GAS	210962	110962.1	110962.2			516004
						GAS	210486	110486.1	110486.2			516004





































































































































MERCEDES (D)

190 SERIES (W201)



















 excl. 2.3-16, 2.5-16, 	(W201)	11.82 - 08.93				GAS	210495	110495.0			516004
				excl. 		GAS	211533	111533.0			
 2.3-16, 2.5-16, 	(W201)	11.82 - 08.93				GAS	210496	110496.0			516004
				excl. 		GAS	211533	111533.0			

200 SERIES (W114/115/116/123/124/126)







 280 S, 280 SE, 280 SEL	(W116)	09.72 - 07.80				GAS	211536	111536.0			
				excl. 		GAS	211535	111535.0			
 200, 220, 230, 250	(W115)	01.68 - 01.77				GAS	211534	111534.0			
						GAS	211535	111535.0			
 200 D, 220 D	(W115)	01.68 - 01.77				GAS	211534	111534.0			
						GAS	211535	111535.0			
 280, 280 E, 240 D	(W114)	06.72 - 11.76				GAS	211534	111534.0			
						GAS	211535	111535.0			
 220, 240 D 	(W115)	01.68 - 12.79				GAS	211534	111534.0			
											
 200, 200 D, 220, 220 D	(W123)	01.76 - 11.84				GAS	211536	111536.0			
						GAS	211535	111535.0			
 230, 240 D, 250	(W123)	01.76 - 11.84				GAS	211536	111536.0			
						GAS	211535	111535.0			
 280, 280 E	(W123)	01.76 - 11.84				GAS	211536	111536.0			
						GAS	211535	111535.0			
 280 S, 280 SE, 280 SEL	(W126)	10.79 - 12.85				GAS	211536	111536.0			
						GAS	211535	111535.0			
 200, 200 E, 230 E, 260 E excl. 4-matic, 	(W124)	11.84 - 06.93				GAS	210495	110495.0			516004
						GAS	211533	111533.0			
 200 D, 250 D, 250 Turbo-D excl. 4-matic, 	(W124)	11.84 - 06.93				GAS	211533	111533.0			
						GAS	210496	110496.0			516004
 	(W124)	11.84 - 06.93				GAS	211533	111533.0			
						GAS	211536	111536.0			
 260 SE	(W126)	09.85 - 06.91				GAS	211536	111536.0			
				excl. 		GAS	211535	111535.0			
 220, 220 D	(W115)	01.68 - 12.78				GAS	211534	111534.0			
						GAS	211535	111535.0			
 230/4, 240 D	(W115)	01.73 - 12.78				GAS	211535	111535.0			
						GAS	211536	111536.0			516004
 200 T, 230 T, 230 TE	(S123)	09.77 - 12.85				GAS	211536	111536.0			
											
 240 T, 250 T, 280 TE	(S123)	09.77 - 12.85				GAS	211536	111536.0			
											
 200 T, 200 TD, 230 TE excl. 4-Matic, 	(S124)	09.85 - 06.93				GAS	210495	110495.0			516004
											
 250 TD, 280 TE excl. 4-Matic, 	(S124)	09.85 - 06.93				GAS	210495	110495.0			516004
											
 	(S124)	09.85 - 06.93				GAS	210496	110496.0			516004
											
 250 C, 250 CE	(W114)	01.73 - 01.77				GAS	211534	111534.0			
						GAS	211535	111535.0			
 280 C, 280 CE	(W115)	01.73 - 01.77				GAS	211535	111535.0			
						GAS	211536	111536.0			
 230 C, 230 CE	(C123)	03.77 - 12.85				GAS	211536	111536.0			
						GAS	211535	111535.0			
 280 C, 280 CE	(C123)	03.77 - 12.85				GAS	211535	111535.0			
						GAS	210495	110495.0			516004
 200 CE, 220 CE, 230 CE, 280 CE excl. 	(C124)	03.87 - 06.93				GAS	210495	110495.0			516004
				excl. 		GAS	211533	111533.0			

MERCEDES (D)





300 SERIES (W116/123/124/126)

350 SE, 350 SEL	(W116)	09.72 - 07.80			∅	GAS	211536	111536.0			
				excl. ⚡	±	GAS	211535	111535.0			
300 D	(W123)	02.76 - 11.85			∅	GAS	211536	111536.0			
				excl. ⚡	±	GAS	211535	111535.0			
300 SD Turbo D 380 SE, 380 SEL	(W126)	01.81 - 06.91 12.79 - 12.86			∅	GAS	211536	111536.0			
				excl. ⚡	±	GAS	211535	111535.0			
300 E, 320 E, 300 D, 300 D Turbo excl. 4-matic, sportline	(W124)	11.84 - 06.93			↘	GAS	210495	110495.0			
				excl. ⚡	∅	GAS	211533	111533.0			
300 SE, 300 SEL	(W126)	09.85 - 06.91			∅	GAS	211536	111536.0			
				excl. ⚡	±	GAS	211535	111535.0			
300 TD	(S123)	09.77 - 11.85			∅	GAS	211536	111536.0			
300 TE, 300 TD Turbo, 320 TE excl. 4-Matic, sportline	(S124)	09.85 - 06.93			↘	GAS	210495	110495.0			516004
											
sportline	(S124)	09.85 - 06.93			↘	GAS	210496	110496.0			516004
											
300 CE, 320 CE excl. sportline	(C124)	03.87 - 05.93			↘	GAS	210495	110495.0			516004
				excl. ⚡	∅	GAS	211533	111533.0			
380 SEC	(C126)	10.81 - 07.85			∅	GAS	211536	111536.0			
				excl. ⚡	±	GAS	211535	111535.0			

















400 SERIES (W116/124/126)

450 SE, 450 SEL	(W116)	03.73 - 07.80			∅	GAS	211536	111536.0			
				excl. ⚡	±	GAS	211535	111535.0			
400 E excl. 4-matic, sportline	(W124)	11.84 - 06.93			↘	GAS	210495	110495.0			516004
					∅	GAS	211533	111533.0			
420 SE, 420 SEL 420 SEC	(W126) (C126)	10.85 - 06.91 10.85 - 06.91			∅	GAS	211536	111536.0			
				excl. ⚡	±	GAS	211535	111535.0			

500 SERIES (W126)



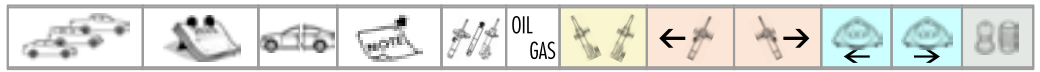

500 SE, 500 SEL, 560 SEL 560 SEL	(W126) (W126)	12.79 - 06.91 09.85 - 06.91			∅	GAS	211536	111536.0			516004
				excl. ⚡	±	GAS	211535	111535.0			
500 SEC 500 SEC, 560 SEC	(C126) (C126)	10.81 - 08.85 09.85 - 06.91			∅	GAS	211536	111536.0			516004
				excl. ⚡	±	GAS	211535	111535.0			

A CLASS (W168/169/176)





140, 160, 190, 160 CDI, 170 CDI	(W168)	07.97 - 08.04			↘	GAS	210499	110499.0	600610	516004
					∅	GAS	211572	111572.0		
	(W168)	07.97 - 08.04			↘	GAS	210499	110499.0	600610	516004
					∅	GAS	211572	111572.0		
 Alternativa con piattello in alluminio	(W168)	07.97 - 08.04			↘	GAS	210515	110515.0		516004
					∅	GAS	211572	111572.0		
	(W169)	09.04 - 06.12			↘	GAS	210501	110501.0	600550	516004
					∅	GAS	211574	111574.0		
 Alternativa monotubo al posteriore	(W169)	09.04 - 06.12			↘	GAS	210501	110501.0	600550	516004
					∅	GAS	211590	111590.0		
150, 170, 200, 160 CDI, 180 CDI, 200 CDI	(W169)	09.04 - 06.12			↘	GAS	210501	110501.0	600550	516004
					∅	GAS	211574	111574.0		

















MERCEDES (D)

180, 200, 180 CDI, 200 CDI, 220 CDI excl. 4-matic	(W176)	06.12 - 05.18				GAS	210512	110512.1	110512.2			516004
							GAS	211587	111587.0			























































A CLASS (W177, V177) *NEW*

 excl. Multilink	(W177, V177)	03.18 -				GAS	212235	112235.1	112235.2			
							GAS	212236	112236.0			























B CLASS (W245/246)

	(W245)	03.05 - 11.11				GAS	210501	110501.0		600550		516004
							GAS	211574	111574.0			
 Alternativa monotubo al posteriore	(W245)	03.05 - 11.11				GAS	210501	110501.0		600550		516004
							GAS	211590	111590.0			
180, 200, 180 CDI, 200 CDI, 220 CDI excl. 4-matic	(W246, W242)	11.11 - 12.18				GAS	210512	110512.1	110512.2			516004
							GAS	211587	111587.0			













C CLASS (W202/203)

 C 180, 200, 220, 230, 240 excl. Esprit, AMG, 	(W202, S202)	05.93 - 03.01 05.93 - 03.01				GAS	211538	111538.0				
				excl. 			GAS	211539	111539.0			
 C 200 D, 220 D, 250 D excl. Esprit, AMG, 	(W202, S202)	05.93 - 03.01 05.93 - 03.01				GAS	211538	111538.0				
				excl. 			GAS	211539	111539.0			
 C 180, 200, 220, 230, 240 excl. Esprit, AMG, 	(W202, S202)	05.93 - 03.01 05.93 - 03.01				GAS	211569	111569.0				
				excl. 			GAS	211539	111539.0			
 C 200 D, 220 D, 250 D excl. Esprit, AMG, 	(W202, S202)	05.93 - 03.01 05.93 - 03.01				GAS	211569	111569.0				
				excl. 			GAS	211539	111539.0			
 C250 TD, C280 excl. Esprit, AMG, 	(W202, S202)	05.93 - 03.01				GAS	211569	111569.0				
							GAS	211570	111570.0			
 Esprit,  sportline excl. AMG	(W202, S202)	05.93 - 03.01				GAS	211556	111556.0				
							GAS	211557	111557.0			
	(W203)	05.00 - 02.07				GAS	210502	110502.0				
							GAS	211575	111575.0			
 T-Model	(S203)	03.01 - 08.07				GAS	210502	110502.0				
							GAS	211575	111575.0			
 Sportcoupé	(CL203)	03.01 - 06.11				GAS	210502	110502.0				
							GAS	211575	111575.0			

C CLASS (W204/S204)

 excl. 4-matic, AMG, 	(W204)	01.07 - 01.14				GAS	210506	110506.0				
							GAS	211582	111582.0			
 T-Model excl. 4-matic, AMG, 	(S204)	08.07 - 08.14				GAS	210506	110506.0				
							GAS	211582	111582.0			
 excl. 4-matic, AMG, 	(C204)	06.11 -				GAS	210506	110506.0				
							GAS	211582	111582.0			
 4-matic	(W204-S204)	07.07 - 08.14				GAS	210511	110511.0				
							GAS	211582	111582.0			

C CLASS (W205/C205/C205) *NEW*

 excl.  , AMG, 4-matic	(W205)	12.13 -				GAS	212187	112187.0				
							GAS	212188	112188.0			
 excl.  , AMG, 4-matic	(C205)	10.15 -				GAS	212187	112187.0				
							GAS	212188	112188.0			



MERCEDES (D)

excl. 1 st , AMG, 4-matic	(S205)	09.14 -				GAS	212187	112187.0			
						GAS	212188	112188.0			516010

CITAN *NEW*

	(415)	11.12 -				GAS	210669	110669.0			516004
						GAS	211827	111827.0			-

CL (C140)

200, 230, 320	(C140)	09.92 - 02.99				GAS	211568	111568.0			
						GAS	212093	112093.0			

CLA

excl. 4-matic, AMG	(C117)	01.13 - 03.19				GAS	210512	110512.1	110512.2			516004
						GAS	211587	111587.0				
Shooting Brake excl. 4-matic, AMG	(X117)	01.15 - 03.19				GAS	210512	110512.1	110512.2			516004
						GAS	211587	111587.0				

CLC

	(203)	05.08 - 06.11				GAS	210502	110502.0			516004
						GAS	211575	111575.0			

CLK (A-C208/209)

200, 200 K, 230, 230 K, 320	(A208, C208)	06.97 - 06.02				GAS	211558	111558.0			
						GAS	211559	111559.0			
200, 200 CGI, 240, 320, 500 excl. sportline	(C209)	06.02 - 05.09				GAS	210502	110502.0			
			200 K, 270 Cdi excl. sportline	(A209)	02.03 - 03.10				GAS	211575	111575.0

CLS

	(C219)	10.04 - 12.10				GAS	211106	111106.0			
						GAS	211583	111583.0			

E CLASS (W124/210)

E 200, 220, 280, 320, 420	(W124)	06.93 - 06.95				GAS	210495	110495.0			516004
			E 200 D, 250 D, 250 D Turbo,			GAS	211533	111533.0			
E 300 D, E 350 D Turbo	(W124)	06.93 - 06.95				GAS	210495	110495.0			516004
			E 280, E 250 D ^{long}			GAS	210495	110495.0			
E 500	(W124)	06.93 - 06.95				GAS	210495	110495.0			516004
						GAS	210496	110496.0			
sportline	(W124)	06.93 - 06.95				GAS	210496	110496.0			516004
						GAS	211533	111533.0			
E 200 T, 220 T, 280 T, 320	(S124)	06.93 - 06.96				GAS	210495	110495.0			516004
			E 250 TD, 300 TD, 300 T TD excl. sportline, 4-Matic			GAS	210496	110496.0			
sportline	(S124)	06.93 - 06.96				GAS	210496	110496.0			516004
						GAS	211533	111533.0			
E 200 C, E 220 C, E 320 C	(C124)	06.93 - 06.97				GAS	210495	110495.0			516004
			excl. sportline			GAS	211533	111533.0			
sportline	(C124)	06.93 - 06.97				GAS	210496	110496.0			516004
						GAS	211533	111533.0			

MERCEDES (D)

E 220, E 320 excl. sportline	(A124)	06.93 - 03.98					GAS	211533	111533.0			516004
sportline	(A124)	06.93 - 03.98					GAS	211533	111533.0			
E 200, E 220 D excl.	(W210)	05.95 - 03.02					GAS	211560	111560.0			
E 230, E 250 D excl.	(W210)	05.95 - 03.02		excl.			GAS	211561	111561.0			
E 280, E 280 TD, E 290 TD excl.	(W210)	05.95 - 03.02					GAS	211560	111560.0			
E 300 D, E 320, E 420 excl.	(W210)	05.95 - 03.02		excl.			GAS	211561	111561.0			
excl.	(S210)	05.95 - 03.03					GAS	211560	111560.0			
Avantgarde excl 4-Matic, AMG,	(W210)	05.95 - 03.02					GAS	211578	111578.0			
Avantgarde excl 4-Matic, AMG,	(S210, T210)	05.95 - 03.02					GAS	211579	111579.0			
Avantgarde excl 4-Matic, AMG,	(S210, T210)	05.95 - 03.02					GAS	211578	111578.0			

E CLASS (W211/S211)

excl.	(W211)	03.02 - 12.08					GAS	211105	111105.0			
excl.	(S211)	03.03 - 07.09					GAS	211576	111576.0			
excl.	(S211)	03.03 - 07.09					GAS	211105	111105.0			
excl.	(S211)	03.03 - 07.09					GAS	211577	111577.0			

E CLASS (W212/S212)

excl. 4-matic, AMG,	(W212)	01.09 - 12.16					GAS	210513	110513.0			
T-Model excl. 4-matic, AMG,	(S212)	11.09 - 12.16					GAS	211588	111588.0			
T-Model excl. 4-matic, AMG,	(S212)	11.09 - 12.16					GAS	210513	110513.0			
4-matic excl. AMG,	(W212)	01.09 - 12.16					GAS	211589	111589.0			
4-matic excl. AMG,	(W212)	01.09 - 12.16					GAS	210514	110514.0			
4-matic excl. AMG,	(S212)	11.09 - 12.16					GAS	211588	111588.0			
4-matic excl. AMG,	(S212)	11.09 - 12.16					GAS	210514	110514.0			
4-matic excl. AMG,	(S212)	11.09 - 12.16					GAS	211589	111589.0			

E CLASS (A207/C207)

	(A207)	01.10 - 12.16					GAS	210516	110516.0			
	(A207)	01.10 - 12.16					GAS	211591	111591.0			
	(C207)	01.09 - 12.16					GAS	210516	110516.0			
	(C207)	01.09 - 12.16					GAS	211591	111591.0			

G CLASS (W460/463)











230 G, 230 GE, 240 GD	(W460)	02.79 - 08.93					GAS	211540	111540.0			
250 GD, 280 GE, 300 GD	(W460)	02.79 - 08.93					GAS	211541	111541.0			
230 GE, 300 GE, 250 GD	(W463)	09.89 - 08.97					GAS	211542	111542.0			
300 GD, 350 GD	(W463)	09.89 - 08.96					GAS	211543	111543.0			
230 G, 230 GE, 240 GD	(W461)	09.93 - 07.00					GAS	211540	111540.0			
250 GD, 280 GE, 300 GD	(W461)	09.93 -					GAS	211541	111541.0			

GLA *NEW*









excl. 4-matic, AMG	(X156)	12.13 -					GAS	210517	110517.1	110517.2		
excl. 4-matic, AMG	(X156)	12.13 -					GAS	211592	111592.0			

MERCEDES (D)





GLC (X253) *NEW*

 excl. †	(X253)	06.15 -				GAS	212189	112189.1	112189.2			
						GAS	212190	112190.0				
 excl. †	(C253)	06.16 -				GAS	212189	112189.1	112189.2			
						GAS	212190	112190.0				





MB SERIES

90, 100, 120 (made in Spain)	(631)	05.84 - 02.96				OIL	201544	101544.0				-
						OIL	201545	101545.0				-
140, 160, 180 (made in Spain)	(631)	05.84 - 02.96				OIL	201546	101546.0				-
						OIL	201547	101547.0				-





ML SERIES (W163)

ML 320	(W163)	02.98 - 06.05				GAS	211571	111571.0				
						GAS	211104	111104.0				

























ML SERIES (W164)

ML 280, 300, 320, 350	(W164)	07.05 - 12.11										
												





S CLASS (W140)

 excl. S 600, †	(W140, C140)	02.91 - 02.99				GAS	211553	111553.0				
				excl. †		GAS	211554	111554.0				





SL SLC SERIES (C107/R107/R129)

 380 SL, 500 SL	(R107, C107)	09.80 - 12.85				GAS	211534	111534.0				
				excl. †		GAS	211535	111535.0				
 300 SL, 420 SL, 500 SL	(R107, C107)	09.85 - 08.89				GAS	211534	111534.0				
				excl. †		GAS	211535	111535.0				
 280 SL, 300 SL	(R107, C107)	05.71 - 08.89				GAS	211534	111534.0				
				excl. †		GAS	211535	111535.0				
 300 SL, 500 SL > Ch. F054767	(R129)	03.89 - 1993										
												
 SL 280, SL 320, SL 500 Ch. F054768 >	(R129)	1993 - 10.01										
												











SLK (R170)

 200, 230 K, 320 excl. AMG	(R170)	09.96 - 04.04				GAS	211563	111563.0				
						GAS	211564	111564.0				

SLK (R171)

	(R171)	04.04 - 02.11				GAS	210505	110505.0				
						GAS	211580	111580.0				





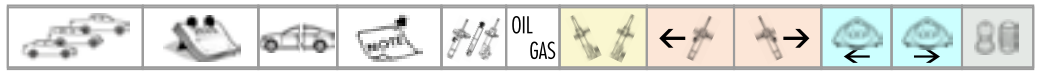





























SPRINTER

 200 series	(901, 902, 903)	01.95 - 05.06				GAS	210497	110497.0				516007
						GAS	211565	111565.0				-
 300 series	(904)	02.96 - 05.06				GAS	210498	110498.0				516007
						OIL	201566	101566.0				-









MERCEDES (D)





SPRINTER II

 200, 300 Series excl H.D. excl 	(906)	06.06 -				GAS	210507	110507.0	600220	516007
						GAS	211584	111584.0		
 200 Series incl H.D.	(906)	06.06 -				GAS	210509	110509.0	600220	516007
										
 300 Series incl H.D. incl 	(906)	06.06 -				GAS	210507	110507.0	600220	516007
										
 400 Series incl H.D. excl 	(906)	06.06 -				GAS	210509	110509.0	600220	516007
						GAS	211586	111586.0		
 400 Series incl 	(906)	06.06 -				GAS	210509	110509.0	600220	516007
										
 4x4	(906)	02.06 -				GAS	210510	110510.0	600220	516007
										









V CLASS (907/910)

 excl.  , 	(638)	02.96 - 07.03				GAS	210500	110500.0		516004
						GAS	211567	111567.0		









VANEO

 1.6, 1.9, 1.7 CDi	(414)	02.02 - 07.05				GAS	210508	110508.0		516004
						GAS	211585	111585.0		









VIANO

 ,  excl.  , 	(639)	09.03 -				GAS	210504	110504.0		516004	
				29A		GAS	211573	111573.0			-
				29B		GAS	211581	111581.0			-









VITO I

 ,  excl.  , 	(638)	02.96 - 10.03				GAS	210500	110500.0		516004
						GAS	211567	111567.0		





VITO II

 ,  excl.  , 	(639)	09.03 -				GAS	210504	110504.0		516007	
				29A		GAS	211573	111573.0			-
				29B		GAS	211581	111581.0			-





VITO III *NEW*

 ,  excl.  , 	(W447)	10.14 -				GAS	212136	112136.0		516006
						GAS	212137	112137.0		

O 300 SERIES

 O 309 B, O 309 D, O 319 B, O 319 D		01.68 - 02.89		30C		OIL	201550	101550.0		-
				30C		OIL	201550	101550.0		

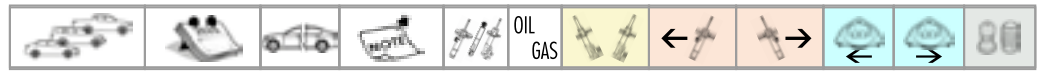

O 400 SERIES

 O 406, O 407		01.68 -		30C		OIL	201550	101550.0		-
				30C		OIL	201550	101550.0		



MERCEDES (D)





O 500 SERIES

 O 508 D		01.68 -		30D	⊗	OIL	201551	101551.0			-
				30D	⊗	OIL	201551	101551.0			-





L 200 SERIES

L 207 D, L 208, L 208 D, L 209 D/DE, L 210, L 210 C/D	(601)	01.78 - 02.96		30A	⊗	OIL	201548	101548.0			-
		10.88 - 02.96		30B	⊗	OIL	201549	101549.0			-



L 300 SERIES

L 307, L 307 D, L 308, L 309 D/DC L 310, L 310 C/D	(602)	10.82 - 02.96		30A	⊗	OIL	201548	101548.0			-
		06.89 - 02.96		30B	⊗	OIL	201549	101549.0			-
L 319, L 319 B/D, L 393		01.61 - 02.96		30C	⊗	OIL	201550	101550.0			-
				30C	⊗	OIL	201550	101550.0			-



L 400 SERIES

L 405, L 406, L 407, L 408, L 409, L 410		10.61 - 02.96		30C	⊗	OIL	201550	101550.0			-
				30C	⊗	OIL	201550	101550.0			-
L 405, L 406, L 407, L 408, L 409, L 410		10.61 - 02.96		30D	⊗	OIL	201551	101551.0			-
				30D	⊗	OIL	201551	101551.0			-

L 500 SERIES

L 508, L 508 DG, LF 508 D, LK 508 DG, LKO 508 DG		01.61 - 02.96		30D	⊗	OIL	201551	101551.0			-
		01.72 - 02.96		30D	⊗	OIL	201551	101551.0			-





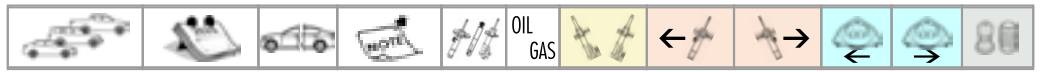

L 600 SERIES

L 608, L 608 D, L 608 DG, LF 608 D, LK 608 D, L 613, L 613 D		01.70 - 02.96		30D	⊗	OIL	201551	101551.0			-
				30D	⊗	OIL	201551	101551.0			-









MINI (GB)























































CABRIOLET

 excl. 	(F57)	11.14-			GAS	210950	110950.1	110950.2			516004
					GAS	212068	112068.0				







COUNTRYMAN

 excl. 	(R60)	08.10 - 10.16			GAS	210948	110948.1	110948.2			516004
					GAS	211229	111229.1	111229.2			







MINI

 One, One D, Cooper incl.  excl. Cooper S	(R50, R53)	06.01 - 03.02									516004
					GAS	211033	111033.0				
 One, One D, Cooper excl. Cooper S  Sport Plus	(R50, R53)	03.02 - 09.06			GAS	210187	110187.1	110187.2	600410		516004
					GAS	211033	111033.0				
 Cooper S incl.  Sport Plus	(R50, R53)	03.02 - 09.06			GAS	210188	110188.1	110188.2	600410		516004
					GAS	211034	111034.0				
 One, Cooper, Cooper S	(R50, R53)	07.04 - 09.06			GAS	210188	110188.1	110188.2	600410		516004
					GAS	211034	111034.0				
	(R56)	10.06 - 11.13			GAS	210941	110941.1	110941.2			516004
					GAS	211220	111220.1	111220.2			
 Clubmann	(R55)	10.07 - 06.14			GAS	210941	110941.1	110941.2			516004
					GAS	211220	111220.1	111220.2			
 Cabriolet	(R57)	11.07 - 06.15			GAS	210941	110941.1	110941.2			516004
					GAS	211220	111220.1	111220.2			
 Coupè	(R58)	09.11 - 05.15			GAS	210941	110941.1	110941.2			516004
					GAS	211220	111220.1	111220.2			
 excl. 	(F56)	12.13-			GAS	210950	110950.1	110950.2			516004
					GAS	212068	112068.0				
 excl. 	(F55)	07.14-			GAS	210950	110950.1	110950.2			516004
					GAS	212068	112068.0				

PACEMAN





 excl. 	(R61)	04.12 - 10.16			GAS	210948	110948.1	110948.2			516004
					GAS	211229	111229.1	111229.2			

ROADSTER













 excl. 	(R59)	11.11 - 04.15			GAS	210941	110941.1	110941.2			516004
					GAS	211220	111220.1	111220.2			

MITSUBISHI (J)



















ASX

	(GA_W_)	02.10 -				GAS	210538	110538.1	110538.2			516004
								GAS	211121	111121.0		





CARISMA

 1.6, 1.9 TD	(DA)	07.95 - 02.99										
 1.8, 1.8 GDI, 1.8 16V	(DA)	07.95 - 02.99				GAS	210788	110788.1	110788.2			516004
						GAS	211183	111183.0				
 1.6, 1.8 GDI, 1.9 D-Di	(DA)	03.99 - 06.06				GAS	210524	110524.1	110524.2			516004
						GAS	211183	111183.0				











COLT II/MIRAGE

 1.2, 1.5, 1.6 Turbo	(C1)	02.84 - 05.86				GAS	210518	110518.0				516004
 1.8 D		02.84 - 05.86				GAS	211593	111593.0				-
 1.2, 1.3, 1.5, 1.6 Turbo	(C1)	06.86 - 04.88				GAS	210519	110519.0				516004
 1.8 D		06.86 - 04.88				GAS	211593	111593.0				-
 1.2, 1.3, 1.5, 1.6 Turbo H	(C1)	06.86 - 04.88				GAS	210519	110519.0				516004
 1.8 D H		06.86 - 04.88				GAS	211593	111593.0				-











COLT III/MIRAGE

 excl. ABS, 4X4	(C5)	04.88 - 05.92				GAS	210393	110393.0				516004
						GAS	211078	111078.0				





COLT IV/MIRAGE

 1.3, 1.6, 1.6 4x4	(CA, CC4A)	12.91 - 12.96				GAS	210525	110525.1	110525.2			516004
						GAS	211108	111108.0				
 1.8 GTI	(CA5A)	12.91 - 12.96				GAS	210526	110526.1	110526.2			516004
						GAS	211108	111108.0				





COLT V

 excl. 4x4	(C1)	09.95 - 05.97				GAS	210527	110527.1	110527.2			516004
						GAS	211108	111108.0				
 excl. 4x4	(C1)	06.97 - 07.05				GAS	210533	110533.1	110533.2			516004
						GAS	211108	111108.0				

COLT VI













 excl. 4x4	(Z)	06.04 - 06.12				GAS	210534	110534.1	110534.2			516004
						GAS	212059	112059.0				

CORDIA





















 1.4, 1.5, 1.6, 1.8 excl. 4X4	(A21_A)	10.82 - 12.86				GAS	210520	110520.0				516004
						GAS	211469	111469.0				-

MITSUBISHI (J)





ECLIPSE

excl. 4x4	(D21A, D22A)	04.91 - 03.94			GAS	210523	110523.0			516004
					GAS	211109	111109.0			
4x4	(D27A)	04.91 - 03.94			GAS	210523	110523.0			516004
					GAS	211114	111114.0			
2.0 excl. 4x4	(D32A)	12.95 - 04.99			GAS	211115	111115.0			516010
					GAS	211116	111116.0			









GALANT/SIGMA/SAPPORO/LAMBDA

1.6, 1.8, 1.8 Turbo, 2.0 excl. □, ABS 2.0 Turbo, 1.8 Turbo D excl. □, ABS	(E1)	09.83 - 08.87 09.83 - 08.87			GAS	210520	110520.0			516004
					GAS	211110	111110.0			
1.6, 1.8, 2.0 excl. 4X4, 4WS, □ 1.8 Turbo D excl. 4X4, 4WS, □	(E3)	09.87 - 10.92 09.87 - 10.92			GAS	210521	110521.0			516004
					GAS	211110	111110.0			
2.0, 2.0 GTI 16V 4X4, incl. 4WS	(E38A, E39A)	06.88 - 10.92								
					GAS	211114	111114.0			
1.8, 2.0, 2.0 D, 2.0T D excl. ☒, □ 2.0 24V, 2.5 V6 4X4 excl. ☒, □	(E5,E64) (E75A, E88A)	11.92 - 08.96 11.92 - 08.96			GAS	211112	111112.0			
					GAS	211111	111111.0			
excl. ☒	(EA)	10.96 - 10.04			GAS	211112	111112.0			
					GAS	211608	111608.0			





















GRANDIS

2.4i excl. ☒ 2.0 Di-D excl. ☒	(NA 4W) (NA 8W)	04.04 - 12.11 09.05 - 12.11			GAS	210536	110536.1	110536.2			516004
					GAS	211624	111624.0				









JEEP

52, J3, J3R J54, J56, J58		01.54 - 12.75 01.74 - 04.77			☒	GAS	211367	111367.0			-
					☒	GAS	211367	111367.0			
J20, J30, J40 J54, J56, J57, J58, J59		01.61 - 05.77 -			☒	OIL	201377	101377.0			-
					☒	OIL	201377	101377.0			



























L200

1.6, 2.0, 2.5 D 4X2	(K11T, K12T, K14T)	11.86 - 08.96			±	GAS	211601	111601.0			
					☒	GAS	211499	111499.0			
2.0, 2.6, 2.5 D 4X4	(K22T, K32T, K33T) (K24 5, K34 T)	11.86 - 08.96			±	GAS	211602	111602.0			
					☒	GAS	211603	111603.0			
2.0, 2.4, 2.5 D 4X2	(K62T, K65T, K64T)	01.96 - 03.03			☒	GAS	211612	111612.0			
					☒	GAS	211499	111499.0			
2.4, 2.5 D 4X4	(K74T, K75T)	06.96 - 03.03			☒	GAS	211606	111606.0			
					☒	GAS	211603	111603.0			
	(KA_T, KB_T)	11.05 - 12.15			☒	GAS	211117	111117.0			
					☒	GAS	211622	111622.0			



L300

1.6, 2.3 D 4X2	(L032P, L062P) (L038P, L068P)	05.80 - 10.86			±	OIL	201311	101311.0			
					☒	GAS	211367	111367.0			
1.8, 2.0 4X4	(L035G, L037G)	05.80 - 10.86			±	OIL	201311	101311.0			
					☒	OIL	201604	101604.0			

















MITSUBISHI (J)

 1.6, 2.0, 2.5 D 4X2	(P02V, P03V, P05V) (P12V, P13V, P15V)	11.86 - 04.94			∅	OIL	201645	101645.0			
					∅	OIL	201368	101368.0			-
 2.0 4X4	(P23V, P24V)	11.86 - 04.94			∓						
					∅	OIL	201634	101634.0			
 1.6, 2.3 D excl. 4X4	(L032P, L038P)	05.80 - 10.86			∓	OIL	201311	101311.0			
					∅						-
 1.6 4X2	(L032P)	11.86 - 04.94			∓	OIL	201311	101311.0			
					∅	OIL	201368	101368.0			-
 2.5 D 4X2	(L032P, L039P)	11.86 - 04.94			∓	OIL	201605	101605.0			
					∅	OIL	201368	101368.0			-
 1.6 4X2	(L032P)	05.80 - 10.86			∓	OIL	201311	101311.0			
					∅	OIL	201368	101368.0			-
 1.8, 2.0 4X4	(L035G, L037G)	05.80 - 10.86			∓	OIL	201311	101311.0			
					∅	OIL	201604	101604.0			-
 2.3 D 4X2	(L038P)	05.80 - 10.86			∓	OIL	201311	101311.0			
					∅	GAS	211367	111367.0			-
 2.0 2.5 D 4X2	(P03W, P05W)	11.86 - 04.94			∅	OIL	201645	101645.0			
					∅	OIL	201368	101368.0			-





LANCER II

 1.2, 1.4	(A155A, A156A)	09.82 - 01.84			/						
					∅	GAS	211469	111469.0			-



















LANCER III

 1.2, 1.5, 1.8 D	(C12, C14, C15)	01.84 - 05.86				GAS	210518	110518.0			516004
					∅	GAS	211593	111593.0			-
 1.2, 1.5, 1.8 D	(C12, C14, C15)	06.86 - 04.88				GAS	210519	110519.0			516004
					∅	GAS	211593	111593.0			-
 1.5, 1.8 D	(C12V, C14V)	01.84 - 05.86				GAS	210518	110518.0			516004
					∅	OIL	201377	101377.0			-
 1.5, 1.8 D	(C12V, C14V)	06.86 - 06.92				GAS	210519	110519.0			516004
					∅	OIL	201377	101377.0			-

LANCER IV

 excl. ABS, 4X4	(C6)	04.88 - 04.92				GAS	210393	110393.0			516004
						GAS	211107	111107.0			

LANCER V

 1.3, 1.6 incl. 4X4, 2.0 D excl. ABS, 1.8 GTi (CB5A)	(CB1A, CB4A) (CB8A, CD4A)	05.92 - 11.95				GAS	210525	110525.1	110525.2		516004
						GAS	211108	111108.0			
 1.8 GTi 16V	(CB5A)	05.92 - 12.96				GAS	210526	110526.1	110526.2		516004
						GAS	211108	111108.0			
 1.6, 2.0 D excl. ABS, 4X4	(CB4W, CB8W)	06.92 - 06.03				GAS	210525	110525.1	110525.2		516004
					∅	GAS	211594	111594.0			-
 1.6 4X4 excl. ABS	(CB4W)	06.92 - 06.03									
					∅	GAS	211594	111594.0			-

MITSUBISHI (J)

LANCER VI

1.3, 1.5, 1.6, 2.0	(CK1, CK2, CK4, CP9)	12.95 - 05.97			GAS	210527	110527.1	110527.2			516004
					GAS	211108	111108.0				
1.3, 1.5, 1.6	(CK1, CK2, CK4)	06.97 - 08.03			GAS	210533	110533.1	110533.2			516004
					GAS	211108	111108.0				

LANCER VII

1.3, 1.6 excl.	(CS1A, CS3A)	06.03 - 12.08			GAS	210535	110535.0			516004
					GAS	211118	111118.0			
2.0	(CS9A)	01.04 - 12.08								
					GAS	211118	111118.0			
1.6, 2.0 excl.	(CS3W, CS9W)	06.03 - 12.08			GAS	210535	110535.0			516004
					GAS	211118	111118.0			
1.6, 2.0	(CS3W, CS9W)	06.03 - 12.08								
					GAS	211118	111118.0			

LANCER VIII

1.5, 1.8, 2.0 DI-D excl.	(CY)	01.08 -			GAS	210537	110537.1	110537.2			516004
					GAS	211120	111120.0				

OUTLANDER II

2.0, 2.2 HDi, 2.4	(CW)	11.06 - 11.12			GAS	210225	110225.1	110225.2			516004
					GAS	211358	111358.0				

PAJERO/SHOGUN/MONTERO

L042G, L043G, L044G L047G, L048G, L049G, P25L	(L04_G)	12.82 - 12.91 01.85 - 12.91			GAS	211595	111595.0			
					GAS	211596	111596.0			
L141G, L144G, L146G, L149G	(L14_G)	01.88 - 12.91			GAS	211595	111595.0			
					GAS	211597	111597.0			
V21, V23, V24, V25, V26 excl. V41, V43, V44, V45, V46 excl.	(V2_C/W) (V4_C/W)	12.90 - 04.00 12.90 - 04.00			GAS	211598	111598.0			
					GAS	211599	111599.0			
V64W, V65W, V68W V74W, V75W, V78W	(V6_W) (V7_W)	04.00 - 12.06			GAS	211113	111113.0			
					GAS	211609	111609.0			
Pinin, Montero	(H66W, H67W, H77W)	10.99 - 06.07			GAS	210528	110528.0			
					GAS	211610	111610.0			
Sport	(K94W, K96W)	11.98 -			GAS	211598	111598.0			
					GAS	211611	111611.0			
3.2 D, 3.8 V6	(V80, V90)	02.07 -			GAS	211119	111119.0			
					GAS	211623	111623.0			

SANTAMO

incl. 4X4		03.99 - 12.04			GAS	210522	110522.0			516004
					GAS	211600	111600.0			

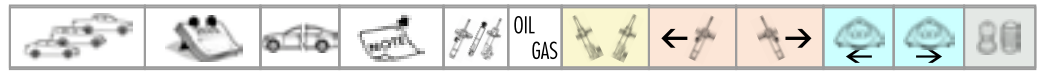

SIGMA

3.0 V6 excl. ECS	(F16A)	12.90 - 07.96			GAS	210529	110529.0			516004
					GAS	211613	111613.0			
3.0 V6 excl. ECS	(F07W)	01.93 - 07.96			GAS	210529	110529.0			516004
					GAS	211614	111614.0			











MITSUBISHI (J)



















SPACE GEAR, L400

2.0, 2.5 TD 4X2 ~ exd. 4x4	(PA3V/5V, PB3V/5V)	05.95 - 05.00			∓							
					∅	OIL	201377	101377.0				









SPACE RUNNER

 incl. 4X4	(N11W, N18W, N21W)	10.91 - 08.99				GAS	210522	110522.0				516004
					∅	GAS	211600	111600.0				
 exd. 4x4	(N63, N64)	08.99 - 01.03				GAS	210530	110530.1	110530.2			516004
					∓	GAS	211620	111620.0				

SPACE WAGON

1.6, 1.8, 2.0, 1.8 TD exd. 4X4	(D04W, D05V/W) (D09V, D09W)	02.83 - 10.91				GAS	210520	110520.0				516004
					∅	GAS	211469	111469.0				
2.0 4X4	(D08W)	02.85 - 10.91										
					∅	GAS	211469	111469.0				
 incl. 4X4	(N3_W, N4_W)	11.91 - 10.98				GAS	210522	110522.0				516004
					∅	GAS	211600	111600.0				
 incl. 4X4	(N84W, N94W)	06.98 - 05.00				GAS	210531	110531.1	110531.2			516004
					∓	GAS	211621	111621.0				
 incl. 4X4 excl. High ground clearance sus.	(N83W, N84W, N94W)	06.00 - 12.04				GAS	210531	110531.1	110531.2			516004
					∓	GAS	211621	111621.0				

TREDIA

 1.4, 1.5, 1.6, 1.8 exd. 4X4	(A21_)	09.82 - 07.86				GAS	210520	110520.0				516004
					∅	GAS	211469	111469.0				
 1.8, 2.0 4x4	(A215G, A217G)	03.85 - 07.86										
					∅	GAS	211469	111469.0				

NISSAN (J)

100 NX

1.6, 2.0 excl.	(B13)	03.90 - 10.94				GAS	210546	110546.1	110546.2			516004
						GAS	210551	110551.1	110551.2			516004

240 MICROBUS

	(KC, C, HC, DC, QC) (DQC, GHC, GHQ)	01.66 - 09.67										
					∞	GAS	211367	111367.0				-
	(GQC, GC, VC)	01.66 - 09.67										
					∞	GAS	211367	111367.0				-
	(KC, C, HC, DC, QC) (DQC, GHC, GHQ)	10.67 - 09.71										
					∞	GAS	211367	111367.0				-
H		10.71 - 12.75										
					∞	GAS	211367	111367.0				-

ALMERA

incl. 2.0 GTi	(N15)	07.95 - 07.97		31A		GAS	210552	110552.1	110552.2			516004
					31B		GAS	211126	111126.0			
	(N15)	08.97 - 03.00		31A		GAS	210806	110806.1	110806.2			516004
					31B		GAS	211190	111190.0			
	(N16)	04.00 - 07.00				GAS	210807	110807.1	110807.2			516004
							GAS	211194	111194.0			
	(N16E)	01.00 - 07.00				GAS	210807	110807.1	110807.2			516004
							GAS	211191	111191.0			
	(N16)	08.00 - 02.01				GAS	210807	110807.1	110807.2			516004
							GAS	211194	111194.0			
	(N16E)	08.00 - 08.03				GAS	210807	110807.1	110807.2			516004
							GAS	211191	111191.0			
	(N16)	07.00 - 11.06				GAS	210807	110807.1	110807.2			516004
							GAS	211191	111191.0			
	(N16E)	09.03 - 09.06				GAS	210814	110814.1	110814.2			516004
							GAS	211191	111191.0			

ALMERA TINO















1.8, 2.2 D	(V10)	08.00 - 10.00				GAS	210809	110809.1	110809.2			516004
							GAS	211192	111192.0			
2.0 16V	(V10)	08.00 - 10.00				GAS	210815	110815.1	110815.2			516004
							GAS	211192	111192.0			
1.8, 2.2 D	(V10)	11.00 - 02.06				GAS	210810	110810.1	110810.2			516004
							GAS	211192	111192.0			
2.0 16V	(V10)	11.00 - 02.06				GAS	210815	110815.1	110815.2			516004
							GAS	211192	111192.0			

BLUEBIRD





1.6, 1.8, 1.8 Turbo	(U11)	11.83 - 05.90				GAS	210816	110816.1	110816.2			516004
							GAS	210031	110031.0			
2.0, 2.0 V6 Turbo, 2.0 D						GAS	210539	110539.0				516004
excl.	(U11)	01.86 - 09.90				GAS	210031	110031.0				516004
excl. Turbo,	(T12)	12.85 - 12.90				GAS	210539	110539.0				516004
excl. Turbo,	(T72)	09.88 - 12.90				GAS	210031	110031.0				516004

NISSAN (J)













CABSTAR

	(A320, A321)	1969 - 1975											
					♀	OIL	201634	101634.0					
	(F20)	01.76 - 12.82											
					∞	OIL	201377	101377.0					-
	(F22)	01.82 - 06.92			♂	GAS	211489	111489.0					
					∞								-
	(F23)	07.92 - 06.10			♂	GAS	211489	111489.0					
					∞	GAS	211606	111606.0					-
	75.28, 90.32	10.98 - 10.06			♂	GAS	211959	111959.0					
					∞	GAS	211960	111960.0					-























CARAVAN-HOMY/E SERIES

E 20, 21, 22		04.78 - 09.80			♂	GAS	211633	111633.0					
													
E 23		09.80 - 08.86			♂	GAS	211633	111633.0					
						OIL	201634	101634.0					



CEDRIC/GLORIA

	2.0, 2.4	(130)	1967 - 1971			♂							
						♂	GAS	211626	111626.0				
	220C, 240C, 260C, 280C	(230)	01.72 - 06.75			♂							
						∞	OIL	201377	101377.0				-
	220 C Diesel	(L230)	01.72 - 06.75			♂							
						∞	OIL	201377	101377.0				-
	200 C, 220 C, 260 C, 280 C	(L230)	06.75 - 06.79			♂							
						∞	OIL	201377	101377.0				-

CHERRY/PULSAR/LANGLEY

	100 A, 120 A	(E10)	09.70 - 09.74			/							
						♂	OIL	201627	101627.0				
	100 A	(E10)	01.71 - 09.74			/							
						+	OIL	201524	101524.0				
	100, 120, 140 A FII	(F10)	09.74 - 07.78			/	OIL	200032	100032.0				
						♂	OIL	201627	101627.0				
	100, 120 A F II	(F10)	09.74 - 07.78			/	OIL	200032	100032.0				
						+	OIL	201524	101524.0				
	100 A, 120 A	(N10)	08.78 - 04.82			/	OIL	200032	100032.0				
						♂	OIL	201627	101627.0				
	100 A, 120 A	(N10)	08.78 - 04.82			/	OIL	200032	100032.0				
						∞	OIL	201638	101638.0				-
	1.3, 1.5, 1.7D excl. 1.5 Turbo	(N12)	04.82 - 10.86			↘	GAS	210540	110540.0				516004
						♂	OIL	201238	101238.0				516010
	1.5 Turbo	(N12)	04.82 - 10.86			♂	OIL	201238	101238.0				516010

CHERRY/ARNA (EUROPE)

1.2, 1.5 GTI		08.83 - 12.85		1A, 2	↘	GAS	210101	110101.1	110101.2				516004
Alfa 33 susp.					♂	OIL	201238	101238.0					516010

NISSAN (J)

excl. 4X4, †	(N13)	06.86 - 09.90				GAS	210541	110541.0			516004
						GAS	210542	110542.0			516004
1.6 4X4	(NN13)	06.86 - 09.90				GAS	210817	110817.1	110817.2		516004
						GAS	210818	110818.1	110818.2		516004

CLIPPER

662H, 663H		01.69 - 05.76				GAS	211626	111626.0			516004
						OIL	201377	101377.0			-
YT, TWT, YHWT40		01.74 - 12.82									
						OIL	201377	101377.0			-

FAIRLADY Z

240 Z, 260 Z	(S30)	01.70 - 06.78				GAS	210030	110030.0			516004

HOMER

Homer 1.5 T Homer 1.25 T	(T641, 642, 20) (T641, T20, F20)	01.68 - 12.76 01.68 - 12.81									516004
						OIL	201377	101377.0			-

INTERSTAR

	(X70)	07.02 -				GAS	211789	111789.0			-
						GAS	211790	111790.0			-
	(X70)	08.03 -				GAS	211789	111789.0			-
						GAS	211790	111790.0			-
	(X70)	07.02 -				GAS	211789	111789.0			-
						OIL	201791	101791.0			-
	(X70)	08.03 -				GAS	211789	111789.0			-
						OIL	201791	101791.0			-

JUKE

	(F15)	06.10 -				GAS	210834	110834.1	110834.2		516004
						GAS	211967	111967.0			-













KUBISTAR

excl. Pampa, CU+ (800 Kg)	(X76)	08.03 -				OIL	200631	100631.0	600390	516004
						GAS	210631	110631.0		
						GAS	211786	111786.0		-
Pampa	(X76)	08.03 -				OIL	200654	100654.0	600390	516004
						GAS	210654	110654.0		
						GAS	211816	111816.0		-
CU+ (800 Kg)	(X76)	08.03 -				OIL	200631	100631.0	600390	516004
						GAS	210631	110631.0		
						GAS	211815	111815.0		-







LAUREL

1.8	(C30)	01.68 - 02.70				OIL	200029	100029.0			516004
						GAS	211626	111626.0			516010
180 L, 200 L, 260 L, 280 L	(C130, C131)	01.72 - 01.77				OIL	200029	100029.0			516004
											-





NISSAN (J)

 180 L, 200 L, 260 L, 280 L	(KC130, KC131)	01.72 - 01.77			/	OIL	200029	100029.0			516004
					♀						
 180 L, 200 L, 240 L, 260 L, 280 L	(C230, C231)	02.77 - 1980			/	OIL	200029	100029.0			516004
					♂						
 180 L, 200 L, 240 L, 280 L	(JC31)	01.81 - 12.85			/	OIL	200029	100029.0			516004
					♀						
 180 L, 200 L, 240 L, 280 L	(C32)	11.84 - 06.90			/						516004
					♀	GAS	211122	111122.0			













LEAF *NEW*

	(ZE0)	11.10 -									
											
	(ZE1)	08.17 -									
											



LEOPARD

1,8	(JF30)	01.80 - 12.82			/	GAS	210030	110030.0			516004
					♀	GAS	211122	111122.0			
2.0, 2.8 SFL, 3.0 Turbo	(PF30, HF30)	01.80 - 12.82			/	GAS	210030	110030.0			516004
											



MAXIMA

 excl. ♀	(J30)	10.88 - 10.94			♀	GAS	210543	110543.1	110543.2		516004
				excl. ♂	/	GAS	210034	110034.0			
 excl. ♀	(A32)	10.94 - 08.00			♀	GAS	210553	110553.1	110553.2		516004
					♀	GAS	211127	111127.0			
 excl. ♀	(CA33)	01.00 - 07.00			♀	GAS	210820	110820.1	110820.2		516004
					♂	GAS	211953	111953.0			
 excl. ♀	(CA33)	08.00 - 11.03			♀	GAS	210821	110821.1	110821.2		516004
					♂	GAS	211954	111954.0			







MICRA I

	(K10)	12.82 - 11.92			♀	OIL	200550	100550.0			516004
					♀	OIL	201124	101124.0			



MICRA II

	(K11)	08.92 - 02.03			♀	GAS	210547	110547.1	110547.2		516004
		08.92 - 02.03			♂	GAS	211628	111628.0			516010

MICRA III

	(K12)	01.03 - 05.10			♀	GAS	210812	110812.1	110812.2	600731	600732	516004
					♂	GAS	211951	111951.0				
 C+C	(K12)	08.05 - 06.10			♀	GAS	210812	110812.1	110812.2	600731	600732	516004
					♂	GAS	211951	111951.0				



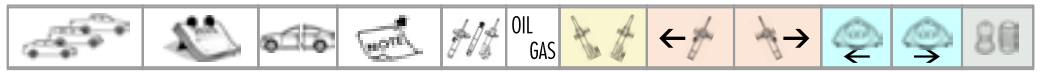

MICRA IV

	(K13)	05.10 -			♀	GAS	210832	110832.1	110832.2			516004
					♂	GAS	211964	111964.0				







NISSAN (J)











MICRA V

	(K14)	12.16 -				GAS	212134	112134.1	112134.2			516004
								GAS	212135	112135.0		





MURANO

	(Z50)	03.05 - 09.08				GAS	210819	110819.1	110819.2			516004
								GAS	211952	111952.0		





NOTE

	(E11)	03.06 - 06.12				GAS	210830	110830.1	110830.2	600731	600732	516004
								GAS	211958	111958.0		
	(E12)	06.13 -				GAS	210832	110832.1	110832.2			516004
								GAS	211964	111964.0		















NV200/EVALIA

	(M20, M20M)	02.10 -				GAS	212143	112143.1	112143.2			516004
								GAS	212144	112144.0		















NV300

	(M20, M20M)	02.10 -				GAS	212143	112143.1	112143.2			516004
								GAS	212144	112144.0		



















NV400

	excl. ruote gemelle	(X62, X62B)	11.11 -				GAS	210875	110875.0				
									GAS	212006	112006.0		
	excl. ruote gemelle	(X62, X62B)	11.11 -				GAS	210875	110875.0				
									GAS	212007	112007.0		
	incl. ruote gemelle	(X62, X62B)	11.11 -				GAS	212118	112118.0				
									GAS	212008	112008.0		

PATHFINDER

	(R50)	09.97 - 01.99				GAS	210808	110808.1	110808.2			516004
								GAS	211950	111950.0		
	(R50)	02.99 - 12.04				GAS	210822	110822.1	110822.2			516004
								GAS	211955	111955.0		
	(R51)	01.05 -				GAS	211196	111196.0				
								GAS	211963	111963.0		

PATROL/SAFARI

	(160, 260)	06.80 - 03.89				+	GAS	211629	111629.0					
								-	GAS	211630	111630.0			
160-743, 260-743		04.89 - 02.98				+	GAS	211631	111631.0					
								+	GAS	211490	111490.0			
	GR I	(Y60)	08.87 - 06.97				+	GAS	211631	111631.0				
									+	GAS	211632	111632.0		
	GR II	(Y61)	06.97 -				+	GAS	211942	111942.0				
									+	GAS	211943	111943.0		

NISSAN (J)

PICK-UP/CAB/KING CAB/NAVARA

	(520, 521, 620)	01.65 - 12.78			♂	GAS	211633	111633.0			
					♀	OIL	201634	101634.0			
4X2 incl. King Cab 4X4 incl. King Cab	(720)	10.79 - 08.85 10.79 - 12.81			♂	GAS	211635	111635.0			
					♀	OIL	201634	101634.0			
4X4 incl. King Cab	(720)	01.82 - 08.85			♂	GAS	211635	111635.0			
					♀	GAS	211596	111596.0			-
4X2	(GD21)	09.85 - 02.98			♂	GAS	211489	111489.0			
					♀	GAS	211636	111636.0			-
4X4	(MD21)	09.85 - 02.98			♂	GAS	211637	111637.0			
					♀	GAS	211636	111636.0			-
4X2	(D22)	02.98 - 04.05			♂	GAS	211944	111944.0			
					♀	GAS	211636	111636.0			-
4X4	(D22)	02.98 - 04.05			♂	GAS	211945	111945.0			
					♀	GAS	211947	111947.0			-
4X4	(D40)	07.05 -			♂	GAS	212123	112123.0			
					♀	GAS	212124	112124.0			-

PIXO

	(UA0)	06.09 -			♂	GAS	212120	112120.1	112120.2			516004
					♀	GAS	211966	111966.0			-	

PRAIRIE

excl. 4X4	(M10)	08.82 - 10.88			♂	GAS	210540	110540.0				516004
					♀	GAS	211638	111638.0				
excl. 4X4	(M11)	10.88 - 07.94			♂	GAS	210543	110543.1	110543.2			516004
					♀	GAS	210035	110035.0				
4X4	(NM11)	10.88 - 07.94			♂	GAS	210543	110543.1	110543.2			516004
					♀							516004





PRIMASTAR

	(X83)	09.02 -			♂	GAS	210648	110648.0	600150			516004
					♀	GAS	211804	111804.0			-	





PRIMERA

1.6, 2.0 D excl. ABS	(P10)	06.90 - 06.96			♂	GAS	211125	111125.0				
				32A	♂	GAS	210544	110544.1	110544.2			516004
1.6, 2.0 D ABS	(P10)	06.90 - 06.96			♂	GAS	211125	111125.0				
					♂	GAS	210823	110823.1	110823.2			516004
2.0, 2.0 e GT, 2.0 GTi	(P10)	06.90 - 06.96			♂	GAS	211125	111125.0				
				32B	♂	GAS	210548	110548.1	110548.2			
1.6, 2.0 2.0 D	(W10)	07.90 - 03.98 07.90 - 02.95			♂	GAS	210545	110545.1	110545.2			516004
					♀	GAS	211639	111639.0			-	
excl. GT, SRi	(P11, WP11)	06.96 - 07.02			♂	GAS	211125	111125.0				
					♂	GAS	211129	111129.0				
GT, Sri	(P11, WP11)	06.96 - 07.02			♂	GAS	211125	111125.0				
					♂	GAS	211129	111129.0				











NISSAN (J)

	(P12, WP12)	01.02 -			GAS	210824	110824.1	110824.2			
						GAS	211193	111193.0			











PULSAR

	(C13)	10.14 -			GAS	212191	112191.1	112191.2			516004
						GAS	211970	111970.0			















QASHQAI/QASHQAI + 2

 excl 4x4	(J10)	02.07 - 12.13			GAS	210831	110831.1	110831.2			516004
						GAS	211961	111961.0			
 4x4	(J10)	02.07 - 12.13			GAS	210831	110831.1	110831.2			516004
						GAS	211962	111962.0			



























QASHQAI II

 excl. 4WD	(J11, J11_)	11.13 -			GAS	210835	110835.1	110835.2			516004
						GAS	211968	111968.0			
 4WD	(J11, J11_)	11.13 -			GAS	210835	110835.1	110835.2			516004
						GAS	211969	111969.0			

























SERENA

1.6, 2.0 D, 2.3 D (L, LX, SLX) excl. SGX	(C23M)	07.92 - 09.01				GAS	210549	110549.1	110549.2			516004
							GAS	211367	111367.0			
2.0 SLX, SGX 2.0 D SGX, 2.3 D SGX	(C23M) (C23M) (C23M)	07.92 - 05.96 07.92 - 09.01 11.95 - 09.01				GAS	210549	110549.1	110549.2			516004
							GAS	211652	111652.0			
2.0 SE	(C23M)	06.96 - 09.01				GAS	210549	110549.1	110549.2			516004
							GAS	211956	111956.0			

SILVIA/GAZELLE/200 SX







200 SX		01.75 - 07.79				OIL	200029	100029.0				516004
												
	(S110)	08.79 - 07.83										516004
												
	(S12)	08.83 - 04.88				GAS	210030	110030.0				
												
1.8 16V Turbo	(S13)	07.88 - 11.94				GAS	210805	110805.1	110805.2			516004
							GAS	211189	111189.0			
2.0 16V Turbo	(S14)	10.93 - 12.99				GAS	210825	110825.1	110825.2			516004
							GAS	211195	111195.0			

SKYLINE











































































 160 K, 180 K  200 K, 240 K, 280 D	(C211)	08.77 - 07.81				OIL	200029	100029.0				
												
 1.8, 2.0, 2.8 D excl. 2.0 Turbo	(R30)	08.81 - 07.85				OIL	200029	100029.0				
												
 2.0 Turbo	(R30)	08.81 - 07.85										
												
 1.8, 2.0	(VR30)	08.81 - 07.85				OIL	200029	100029.0				
												

NISSAN (J)







STANZA

 1.6, 1.8, 1.7 D	(T11)	06.81 - 12.85			/						
 1.6, 1.8, 2.0, 2.0 D excl. Turbo	(T12)	01.86 - 12.90			/	GAS	210539	110539.0			516004

SUNNY/SENTRA

 1.2	(B110)	01.70 - 12.74			/						
 1.4 Excellent	(B110)	01.71 - 02.73			/	OIL	200029	100029.0			
 1.2	(B110, B120)	01.70 - 12.74			/						
 120 Y	(B210)	01.73 - 12.75			/						
 120 Y	(B210)	01.73 - 12.75			/						
 120 Y, 140 Y	(B310)	01.78 - 12.81			/						
 140 Y	(B310)	01.78 - 12.81			/	OIL	201377	101377.0			
 120 Y, 140 Y	(B310)	01.78 - 12.81			/						
 1.3, 1.5, 1.7 D	(B11)	03.82 - 09.85			/	GAS	210540	110540.0			
 1.3, 1.5, 1.7 D	(B11)	03.82 - 09.85			/	OIL	201238	101238.0			
 1.3, 1.5, 1.7 D	(B11)	03.82 - 09.85			/	GAS	210540	110540.0			
 1.3, 1.5, 1.7 D	(B11)	03.82 - 09.85			/	OIL	201238	101238.0			
 1.3, 1.5, 1.7 D	(B11)	03.82 - 09.85			/	GAS	210540	110540.0			
 1.3, 1.5, 1.7 D	(B11)	01.83 - 12.91			/						
 1.3, 1.5, 1.7 D	(B11)	03.82 - 09.85			/	GAS	210540	110540.0			
 1.3, 1.5, 1.7 D	(B11)	01.83 - 12.91			/	GAS	211642	111642.0			
 1.3, 1.5, 1.7 D	(B12, N13)	09.85 - 10.90			/	GAS	210541	110541.0			
 1.3, 1.5, 1.7 D	(B12, N13)	09.85 - 10.90			/	GAS	210542	110542.0			
 4x4	(B12)	06.86 - 09.90			/	GAS	210817	110817.1	110817.2		
 4x4	(B12)	06.86 - 09.90			/	GAS	210818	110818.1	110818.2		
 1.4, 2.0 D	(N14)	10.90 - 10.95			/	GAS	210546	110546.1	110546.2		
 1.4, 2.0 D	(N14)	10.90 - 10.95			/	GAS	210811	110811.1	110811.2		
 1.6, 2.0	(N14)	10.90 - 10.95			/	GAS	210546	110546.1	110546.2		
 1.6, 2.0	(N14)	10.90 - 10.95			/	GAS	210551	110551.1	110551.2		
 4x4	(N14)	10.90 - 10.95			/	GAS	210826	110826.1	110826.2		
4x4	(N14)	10.90 - 10.95			/	GAS	210827	110827.1	110827.2		
4x4	(Y10)	11.90 - 12.95			/	GAS	210546	110546.1	110546.2		
(Q-BIC) 4x4	(Y10)	12.91 - 12.95			/	GAS	211643	111643.0			
4x4	(Y10)	11.90 - 12.95			/	GAS	210826	110826.1	110826.2		
4x4	(Y10)	11.90 - 12.95			/	GAS	211957	111957.0			

TERRANO I/PATHFINDER

 4x4	(WD21)	07.86 - 02.96			/	GAS	211644	111644.0			
 4x4	(WD21)	07.86 - 02.96			/	GAS	211625	111625.0			

NISSAN (J)

TERRANO II

excl. 1 ^o	(R20)	10.92 - 09.07			1/2	GAS	211644	111644.0			516004
					∞	GAS	211653	111653.0			-

TIIDA

excl 4x4	(SC11X)	05.06 - 06.13			∞	GAS	210833	110833.1	110833.2			516004
					1/2	GAS	211965	111965.0				

TRADE

2.0 (made in Spain)		03.87 - 12.00			1/2	OIL	201654	101654.0			
					∞	OIL	201789	101789.0			-
2.8 (made in Spain)		03.87 - 03.93			1/2	OIL	201655	101655.0			
					∞	OIL	201789	101789.0			-
2.8 (made in Spain)		03.87 - 03.93			1/2	OIL	201655	101655.0			
					∞	OIL	201656	101656.0			-
ECO 100		03.87 - 12.00			1/2	OIL	201948	101948.0			
					∞	OIL	201949	101949.0			-

URVAN

	(E20)	04.78 - 06.80			1/2						
					∞	OIL	201634	101634.0			
	(E23)	07.80 - 10.86			1/2	OIL	201645	101645.0			
					∞	OIL	201634	101634.0			
,	(E24)	11.86 - 05.97			1/2	OIL	201646	101646.0			
					∞	OIL	201604	101604.0			-

VANETTE

, , made in Spain	(C120, C220) (C220)	01.78 - 06.87 04.87 -			∞	OIL	201647	101647.0			-
					∞	OIL	201648	101648.0			-
, ~	(GC22)	10.86 - 12.95			∞	OIL	201649	101649.0			-
					∞	GAS	211367	111367.0			-
, III ,	(GC22) (GC32M)	10.86 - 12.95 01.91 - 12.95			∞	OIL	201649	101649.0			-
					1/2	OIL	201650	101650.0			

VANETTE CARGO

1.6, 2.0 D, 2.3 D excl. SGX	(C23M)	09.94 - 05.01		I	∞	GAS	210549	110549.1	110549.2			516004
					∞	GAS	211367	111367.0			-	
2.0 2.0 D, 2.3 D SGX	(C23M) (C23M)	09.94 - 05.01		I + 1	∞	GAS	210549	110549.1	110549.2			516004
					∞	GAS	211652	111652.0			-	















VIOLET

, 140 J, 160 J excl. 160 J SSS	(L710)	01.73 - 04.77			/						
					1/2						
, 140 J, 160 J SSS	(L710)	01.73 - 04.77			/						
					1/2	GAS	211626	111626.0			
, 140 J, 160 J SSS	(A10)	05.77 - 12.81			/						
					1/2						
160 J	(A10)	05.77 - 12.81			/						
					∞	OIL	201377	101377.0			-



NISSAN (J)

X-TRAIL

	(T30)	07.01 - 05.07			GAS	210828	110828.1	110828.2			516004
					GAS	210829	110829.1	110829.2			516004
	(T31)	06.07 - 07.14			GAS	210665	110665.1	110665.2			516004
					GAS	211826	111826.0			-	
 incl. 4WD excl. †	(T32)	12.13 -			GAS	212192	112192.1	112192.2			516004
					GAS	211969	111969.0			-	

OPEL (D)

ADAM

	(M13)	10.12 - 02.19				GAS	210873	110873.1	110873.2	600500	516004
						GAS	212005	112005.0		516010	

AGILA

	(H00)	09.00 - 12.07				GAS	210574	110574.1	110574.2	600620	516004
						GAS	211696	111696.0		-	
1.3 CDTi	(H00)	08.03 - 12.07				GAS	210874	110874.1	110874.2		516004
						GAS	211696	111696.0		-	
	(H08)	04.08 - 10.14				GAS	210748	110748.1	110748.2		516004
						GAS	211867	111867.0		516010	

AMPERA

	(R12)	11.11 - 03.15									516004
										516010	

ANTARA

excl.	(L07)	05.06 -				GAS	210869	110869.1	110869.2	600170	516004
						GAS	211706	111706.0		-	

ASCONA A/B

(A)	(84, 89)	10.70 - 08.75									
						OIL	201660	101660.0			
(B)	(81, 86, 87, 88)	09.75 - 08.81				OIL	201661	101661.0			
						OIL	201660	101660.0			

ASCONA C

	> Ch. F1003026, > Ch. F5000000, > Ch. F6000000	(J82)	08.81 - 08.84				GAS	210041	110041.0		516004
							GAS	211662	111662.0		516010
	Ch. F1003027>, Ch. F5000001>, Ch. F6000001>	(J82)	09.84 - 10.88				GAS	210042	110042.0		516004
							GAS	211662	111662.0		516010

ASTRA F

excl. GT, GSi	(53, 54, 56, 57, 58, 59)	09.91 - 03.98				OIL	200043	100043.0	600020	516004
						GAS	210043	110043.0		
						OIL	201663	101663.0		
						GAS	211663	111663.0		
GT	(53, 54, 56, 57, 58, 59)	09.91 - 03.98				GAS	210043	110043.0	600020	516004
						GAS	211663	111663.0		
GSi	(53, 54, 56, 57, 58, 59)	09.91 - 03.98				GAS	210043	110043.0	600020	516004
						GAS	211685	111685.0		
Caravan	(51, 52)	09.91 - 03.98				OIL	200043	100043.0	600020	516004
						GAS	210043	110043.0		
						OIL	201664	101664.0		
						GAS	211664	111664.0		
	(53_B)	09.91 - 03.98				GAS	210043	110043.0	600020	516004
						GAS	211663	111663.0		

OPEL (D)

ASTRA G

excl. 2.0 OPC	(F48, F08, F69)	04.98 - 03.04				GAS	210562	110562.1	110562.2	600380	516004
						GAS	211689	111689.0			-
excl. 2.0 OPC,	(F35)	04.98 - 08.04				GAS	210562	110562.1	110562.2	600380	516004
				excl.		GAS	211690	111690.0			-

ASTRA H

1.4, 1.6 incl. GTC, , excl. IDS,	(A04)	03.04 - 05.14				GAS	210569	110569.1	110569.2	600160	516004
						GAS	211703	111703.0			-
1.8, 1.3 CDTi, 1.7 CDTi, 1.9 CDTi incl. GTC, , excl. IDS,	(A04)	03.04 - 05.14				GAS	210569	110569.1	110569.2	600160	516004
						GAS	211703	111703.0			-
1.4, 1.6 incl. , excl. IDS,	(A04)	08.04 - 05.14				GAS	210569	110569.1	110569.2	600160	516004
						GAS	211702	111702.0			-
1.8, 1.3 CDTi, 1.7 CDTi, 1.9 CDTi incl. , excl. IDS,	(A04)	08.04 - 05.14				GAS	210569	110569.1	110569.2	600160	516004
						GAS	211702	111702.0			-

ASTRA J

	(P10)	09.09 - 07.12				GAS	210871	110871.1	110871.2		516004
						GAS	212003	112003.0			516010
	(P10)	08.12 - 10.15				GAS	212206	112206.1	112206.2		
						GAS	212003	112003.0			516010

ASTRA K *NEW*

excl.	(B16)	06.15 -				GAS	212193	112193.1	112193.2		516004
						GAS	212194	112194.0			516010

CALIBRA

2.0, 2.0 16V, 2.5 V6 excl. 2.0 Turbo,	(85)	06.90 - 07.97				GAS	210044	110044.0	600030		
				excl.		GAS	211667	111667.0			

CAMPO/BRAVA



TFR Series 4X2	(TF)	08.91 - 12.01									
											-
TFS Series 4X4	(TF)	08.91 - 12.01				GAS	211670	111670.0			
						GAS	211490	111490.0			-

COMBO

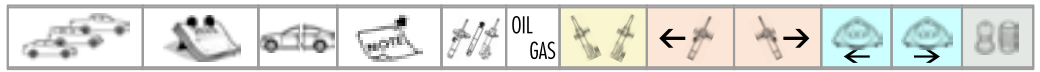

















Kadett E Combo		01.86 - 07.94				OIL	200046	100046.0			516004	
						GAS	210046	110046.0			516004	
Corsa B Combo	(71)	07.94 - 10.01				OIL	200554	100554.0	600370		516004	
						GAS	210554	110554.0			-	
Corsa C Combo Van, Tour		10.01 - 12.11				GAS	210566	110566.1	110566.2	600380	516004	
						GAS	211699	111699.0			-	
Furgonato, Tour excl. trasporto persone	(X12)	02.12 -				GAS	210176	110176.1	110176.2	600541	600542	516004
						GAS	211307	111307.0			-	
Promiscuo (trasporto persone)	(X12)	02.12 -				GAS	210176	110176.1	110176.2	600541	600542	516004
						GAS	212016	112016.0			-	













OPEL (D)

Life 	(X19)	06.18 -				GAS	212224	112224.0			516004
						GAS	212225	112225.0			-

















COMMODORE A/B/C

  2.2, 2.5		01.67 - 01.72				OIL	201673	101673.0			
						GAS	211674	111674.0			
  2.5, 2.5 GS, 2.8 GS, 2.8 GS/E		01.72 - 07.78				OIL	201673	101673.0			
						OIL	201675	101675.0			
  2.5 S		08.78 - 12.82				OIL	200045	100045.0			
						OIL	201675	101675.0			

















CORSA A

 excl. 1.6 GSI		09.82 - 03.93				OIL	200554	100554.0	600370	516004
						GAS	210554	110554.0		516004
						OIL	201671	101671.0		516010
						GAS	211671	111671.0		516010
 1.6 GSI		05.88 - 03.93				GAS	210554	110554.0	600370	516004
						GAS	211671	111671.0		516010





CORSA B

 excl. GSI 1.6 16V		02.93 - 11.00				OIL	200554	100554.0	600370	516004
						GAS	210554	110554.0		516004
						OIL	201671	101671.0		516010
						GAS	211671	111671.0		516010
 GSI 1.6 16V		02.93 - 11.00				GAS	210554	110554.0	600370	516004
						GAS	211671	111671.0		516010
 Combo		07.94 - 10.01				OIL	200554	100554.0	600370	516004
						GAS	210554	110554.0		516004
						OIL	201679	101679.0		-













CORSA C

 	(F08, F68)	09.00 - 12.09				GAS	210566	110566.1	110566.2	600380	516004
						OIL	201695	101959.0			
				33A		GAS	211695	111695.0			
	(F08, F68)	09.00 - 12.09				GAS	210566	110566.1	110566.2	600380	516004
					33B		GAS	211698	111698.0		
 Combo Van, Tour	(F08, W5L)	09.00 - 12.09				GAS	210566	110566.1	110566.2	600380	516004
							GAS	211699	111699.0		

CORSA D





	(S07)	07.06 - 08.14				GAS	210571	110571.1	110571.2	600500	516004
							GAS	211704	111704.0	600781	600782

CORSA E











 excl. 1.6 turbo,  , 	(X15)	09.14 -				GAS	210877	110877.1	110877.2	600500	516004
							GAS	212010	112010.0	600781	600782
 Van	(X15)	09.14 -				GAS	210877	110877.1	110877.2	600500	516004
							GAS	212010	112010.0	600781	600782

OPEL (D)





CROSSLAND X *NEW*

	(P17)	03.17 -			GAS	212239	112239.1	112239.2			
					GAS	211739	111739.0				





FRONTERA A

 incl. sport ~ , > Ch. SV720102		03.92 - 02.95			GAS	211644	111644.0			
					GAS	211676	111676.0			
 incl. sport ~ , Ch. SV720103 >		02.95 - 10.98			GAS	211687	111687.0			
					GAS	211676	111676.0			





FRONTERA B

 incl. sport		10.98 - 12.05			GAS	211692	111692.0			
					GAS	211693	111693.0			





GRANDLAND

 incl. sport		10.98 - 12.05			GAS	211692	111692.0			
					GAS	211693	111693.0			





INSIGNIA A

	(G09)	07.08 - 03.17			GAS	210870	110870.1	110870.2	600440	516004
					GAS	212002	112002.0			

















INSIGNIA B (Z18)

	(G09)	07.08 - 03.17			GAS	210870	110870.1	110870.2	600440	516004
					GAS	212002	112002.0			



















KADETT A / B

		03.63 - 08.73			OIL	201677	101677.0			
					GAS	211674	111674.0			

KADETT C





















 ,  SR		08.73 - 07.79			OIL	201661	101661.0			
					OIL	201675	101675.0			
 GT/E, Rallye		08.73 - 07.79			OIL	201661	101661.0			
										
 Caravan City		08.73 - 07.79 08.73 - 07.79			OIL	201661	101661.0			
					GAS	211674	111674.0			

KADETT D



 ,  excl. GTE	(31, 34, 41, 44)	08.79 - 08.84			OIL	200046	100046.0			516004
					GAS	210046	110046.0			516004
					OIL	201662	101662.0			
					GAS	211662	111662.0			
 GTE	(31, 34, 41, 44)	02.83 - 08.84			GAS	210046	110046.0			516004
					GAS	211662	111662.0			
	(35, 36, 45, 46)	08.79 - 08.84			OIL	200046	100046.0			516004
					GAS	210046	110046.0			516004
					OIL	201678	101678.0			

OPEL (D)



KADETT E

   excl. GSI > Ch. J 2791967 > Ch. J 5273427	(33, 34, 39, 43, 43B, 44, 49)	08.84 - 07.88		/	OIL	200046	100046.0			516004
				/	GAS	210046	110046.0			516004
				∅	OIL	201662	101662.0			
				∅	GAS	211662	111662.0			
   excl. GSI Ch. J 2791968 > Ch. J 5273428 >	(33, 34, 39, 43, 43B, 44, 49)	08.88 - 07.91		/	OIL	200046	100046.0			516004
				/	GAS	210046	110046.0			516004
				∅	OIL	201663	101663.0			
				∅	GAS	211663	111663.0			
  GSI > Ch. J 2791967 > Ch. J 5273427	(33, 34, 39, 43, 43B, 44, 49)	08.84 - 07.88		/	GAS	210046	110046.0			516004
				∅	GAS	211662	111662.0			
  GSI Ch. J 2791968 > Ch. J 5273428 >	(33, 34, 39, 43, 43B, 44, 49)	08.88 - 07.91		/	GAS	210046	110046.0			516004
				∅	GAS	211663	111663.0			
 Caravan	(35, 36, 45, 46)	08.84 - 07.91		/	OIL	200046	100046.0			516004
				/	GAS	210046	110046.0			516004
				♀	OIL	201664	101664.0			-
				♀	GAS	211664	111664.0			-
 Combo	(38, 48)	01.86 - 07.94		/	OIL	200046	100046.0			
				/	GAS	210046	110046.0			516004
				∅	OIL	201679	101679.0			-



KARL

	(C16)	01.15 - 03.18		≠	GAS	212277	112277.1	112277.2			
				∅	GAS	212278	112278				



MANTA A

	(58, 59)	09.70 - 08.75		∅							
				∅	OIL	201675	101675.0				



MANTA B

 excl. GT/E, GSI	(58, 59)	09.75 - 08.88		∅	OIL	201661	101661.0			
				∅	OIL	201660	101660.0			
GT/E, GSI	(58, 59)	09.75 - 08.88		∅						
				∅	OIL	201660	101660.0			

MERIVA A



	(X03)	05.03 - 05.10		≠	GAS	210566	110566.1	110566.2	600380	516004
				∅	GAS	211699	111699.0			-

MERIVA B



	(S10)	06.10 - 03.17		≠	GAS	210872	110872.1	110872.2		516004
				∅	GAS	212004	112004.0			-

OPEL (D)









MOKKA / MOKKA X

excl. 4X4, †	(J13)	06.12 -					GAS	210876	110876.1	110876.2			516004
												GAS	212009



MOKKA II

excl. 4X4, †, MOKKA-e	(76)	10.20 -											
													







MONTREY

	(UBS)	06.92 - 03.95					GAS	211670	111670.0				
												GAS	211680
	(UBS)	04.95 - 07.98					GAS	211688	111688.0				
												GAS	211680
	(M98)	07.98 - 08.99					GAS	211707	111707.0				
												GAS	212001









MONZA

	(22)	02.78 - 08.86					OIL	200045	100045.0				516004
													









MOVANO

 2.8T, 3.3T, 3.5T	(E9, F9, J9)	07.98 -					GAS	211789	111789.0				-
												GAS	211790
 3.5T	(H9, U9)	07.98 -					GAS	211789	111789.0				-
												OIL	201791



MOVANO B

 excl. ruote gemelle	(X62)	05.10 -					GAS	210875	110875.0				516004
												GAS	212006
 excl. ruote gemelle	(X62)	05.10 -					GAS	210875	110875.0				516004
												GAS	212007
 incl. ruote gemelle	(X62)	05.10 -					GAS	212118	112118.0				516004
												GAS	212008

OMEGA A

 1.8, 2.0, 2.4 excl. †	(16, 17, 19)	09.86 - 05.94					GAS	210555	110555.0				516004
												GAS	211682
 2.3 D, 2.3 TD excl. †	(16, 17, 19)	09.86 - 05.94					GAS	210556	110556.0				516004
												GAS	211682
 Caravan excl. †	(66, 67)	09.86 - 05.94					GAS	210555	110555.0				516004
												GAS	211683

OMEGA B

 2.0, 2.0 16V, 2.2 16V excl. †	(25, 26, 27)	05.94 - 07.03					GAS	210557	110557.0				516004
												GAS	211682

OPEL (D)

2.0 DTi, 2.2 DTi, 2.5 TD, 2.5 DTi 2.5 V6, 3.0 V6, 3.2 V6 excl.	(25, 26, 27)	05.94 - 07.03 05.94 - 07.03				GAS	210558	110558.0			516004
							GAS	211682	111682.0		
2.0, 2.0 16V, 2.2 16V excl.	(21, 22, 23)	05.94 - 07.03				GAS	210557	110557.0			516004
							GAS	211683	111683.0		
2.0 DTi, 2.2 DTi, 2.5 TD, 2.5 DTi 2.5 V6, 3.0 V6, 3.2 V6 excl.	(21, 22, 23)	05.94 - 07.03 05.94 - 07.03				GAS	210558	110558.0			516004
							GAS	211683	111683.0		

REKORD A / B / C

excl. 2.2, 2.6		01.63 - 12.71				OIL	201673	101673.0			
							GAS	211674	111674.0		

REKORD D

, excl. 2.1 D		01.72 - 08.77				OIL	201673	101673.0			
							OIL	201675	101675.0		
2.1 D		01.72 - 08.77				OIL	201673	101673.0			
							OIL	201660	101660.0		
Caravan		01.72 - 08.77				OIL	201673	101673.0			
							GAS	211684	111684.0		
1.5 Turbo	(N12)	04.82 - 10.86									
							OIL	201238	101238.0		

REKORD E

1.7, 1.9, 2.0		08.77 - 08.86				OIL	200045	100045.0			
							OIL	201675	101675.0		
2.1 D, 2.2 D, 2.2 TD		08.77 - 08.86				OIL	200045	100045.0			
							OIL	201660	101660.0		
Caravan		08.77 - 08.86				OIL	200045	100045.0			
							GAS	211684	111684.0		

SENATOR A / B







	(29)	02.78 - 08.87				OIL	200045	100045.0			516004
											516010
excl. 3.0 24V,		09.87 - 04.94				GAS	210555	110555.0			516004
							GAS	211682	111682.0		
3.0 24V excl.		09.89 - 04.94				GAS	210556	110556.0			516004
							GAS	211682	111682.0		

SIGNUM





> Ch. 48999999 excl. ,		05.03 - 08.04				GAS	210567	110567.1	110567.2	600770	516004
				excl.			GAS	211700	111700.0		
> Ch. 48999999 ,		05.03 - 08.04				GAS	210568	110568.1	110568.2	600770	516004
				excl.			GAS	211701	111701.0		
Ch. 51000001 > excl. IDS		09.04 - 12.08				GAS	210573	110573.1	110573.2		516004
							GAS	211700	111700.0		

OPEL (D)





SINTRA

		11.96 - 04.99				GAS	210563	110563.0			516004
				excl. 		GAS	211691	111691.0			-































TIGRA

	1.4 16V, 1.6 16V	(95)	07.94 - 12.00				GAS	210554	110554.0	600370	516004
							GAS	211671	111671.0		516010























TIGRA TWINTOP

		(X04)	06.04 - 12.10				GAS	210566	110566.1	110566.2	600380	516004
							GAS	211695	111695.0			516010





















VECTRA A

	excl. 4X4, 2.0 16V, 2.5 V6	(86_ 87, 88, 89)	09.88 - 11.95				GAS	210044	110044.0	600030	516004
					excl. 		OIL	201663	101663.0		516010
					excl. 		GAS	211663	111663.0		516010
	2.0 16V excl. 4X4 > Ch. NV199999 > Ch. N1999999 > Ch. N5999999	(86_ 87, 88, 89)	09.88 - 11.92				GAS	210044	110044.0	600030	516004
					excl. 		GAS	211682	111682.0		516010
	2.0 16V excl. 4X4 Ch. NV199999 > Ch. N1999999 > Ch. N5999999 >	(86_ 87, 88, 89)	01.93 - 11.95				GAS	210044	110044.0	600030	516004
					excl. 		OIL	201663	101663.0		516010
					excl. 		GAS	211663	111663.0		516010
	1.8, 2.0, 2.0 16V Turbo 4X4	(86_ 87, 88, 89)	09.88 - 11.95				GAS	210044	110044.0	600030	516004
					excl. 		GAS	211682	111682.0		516010

VECTRA B

	1.6, 1.8, 2.0 1.6 16V, 1.8 16V, 2.0 16V	(36, 38)	08.95 - 03.02				GAS	210560	110560.1	110560.2	600380	516004
							GAS	211130	111130.0			
	1.7 TD, 2.0 Di/DTi 16V, 2.2 DTi 16V 2.5, 2.6 V6	(36, 38)	08.95 - 03.02 08.95 - 03.02				GAS	210561	110561.1	110561.2	600380	516004
							GAS	211130	111130.0			
	1.6, 1.8, 2.0 1.6 16V, 1.8 16V, 2.0 16V	(31)	08.95 - 03.02				GAS	210560	110560.1	110560.2	600380	516004
					excl. 		GAS	211130	111130.0			
	1.7 TD, 2.0 Di/DTi 16V, 2.2 DTi 16V 2.5 V6, 2.6 V6	(31)	08.95 - 03.02 08.95 - 03.02				GAS	210561	110561.1	110561.2	600380	516004
					excl. 		GAS	211131	111131.0			



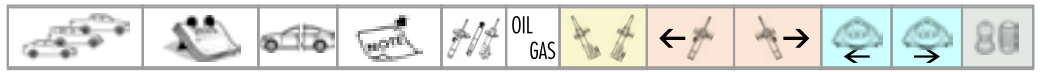

VECTRA C

	excl. 3.0 CDTI excl.  ,  , IDS > Ch. 48999999	(Z02)	04.02 - 08.04				GAS	210567	110567.1	110567.2	600770	516004
					excl. 		GAS	211700	111700.0			
	excl. 3.0 CDTI  ,  , excl. IDS > Ch. 48999999	(Z02)	04.02 - 08.04				GAS	210568	110568.1	110568.2	600770	516004
					excl. 		GAS	211701	111701.0			
	Ch. 51000001 > excl. IDS	(Z02)	09.04 - 01.09				GAS	210573	110573.1	110573.2		516004
							GAS	211700	111700.0			







OPEL (D)





VIVARO

	(X83)	08.01 -				GAS	210648	110648.0	600150	516007
				GAS	211804	111804.0			-	





VIVARO II

	(X83)	08.01 -				GAS	210648	110648.0	600150	516007
				GAS	211804	111804.0			-	





ZAFIRA A

 excl. 2.0 Turbo OPC	(T98)	04.99 - 07.05				GAS	210564	110564.1 110564.2	600380	516004
				GAS	211694	111694.0			-	

ZAFIRA B

	(A05)	07.05 - 04.15				GAS	210569	110569.1 110569.2	600160	516004
				GAS	211703	111703.0			-	

ZAFIRA C

	(P12)	10.11 -				GAS	210871	110871.1 110871.2		516004
				GAS	212003	112003.0			516010	

PEUGEOT (F)

106

0.9, 1.0, 1.1, 1.4, 1.4 D, 1.5 D, Entrepise	(1A, 1C)	09.91 - 04.96		/	OIL	200022	100022.0	600120	516004	
				/	GAS	210022	110022.0			
				∅	OIL	201340	101340.0			-
				∅	GAS	211340	111340.0			-
1.3 Rallye, 1.4 Xsi, 1.6, 1.6 Xsi	(1A, 1C)	09.91 - 04.96		/	OIL	200022	100022.0	600120	516004	
				/	GAS	210022	110022.0			
				∅	GAS	211340	111340.0			-

107

1.0i, 1.4D	(PM, PN)	06.05 - 05.14		∅	GAS	210223	110223.1	110223.2			516004
				∅	GAS	211356	111356.0				

108

		05.14 -		∅	GAS	210223	110223.1	110223.2			516004
				∅	GAS	211356	111356.0				

204

		10.65 - 01.70		/							
				∅	OIL	201133	101133.0				
		02.70 - 06.72		/	OIL	200048	100048.0				
				∅	OIL	201133	101133.0				
		07.72 - 07.77		/	OIL	200048	100048.0				
				∅	OIL	201133	101133.0				

205

excl. GTi, CTi, Rallye, 1.7 TD, F	(741 A/C, 20 A/C)	02.83 - 09.98		∅	OIL	200575	100575.0			516004	
				∅	GAS	210575	110575.0				
				∅	OIL	201344	101344.0			-	
				∅	GAS	211709	111709.0			-	
1.3 Rallye, 1.6 GTi, 1.9 GTi	(741 A/C, 20 A/C)	12.84 - 09.98		∅	GAS	210576	110576.1	110576.2			516004
				∅	GAS	211708	111708.0			-	
1.9 Gentry, 1.7 TD	(741 A/C, 20 A/C)	01.90 - 09.98		∅	OIL	200577	100577.1	100577.2			516004
				∅	GAS	210577	110577.1	110577.2			
				∅	OIL	201344	101344.0			-	
				∅	GAS	211709	111709.0			-	
1.6 CTi, 1.9 CTi	(741B, 20D)	04.86 - 12.94		∅	OIL	200575	100575.0			516004	
				∅	GAS	210575	110575.0			516004	
				∅	OIL	201344	101344.0			-	
				∅	GAS	211709	111709.0			-	
F		03.94 -		∅	GAS	210575	110575.0			516004	
				∅						-	

206

1.1, 1.4, 1.6, 1.9 D incl. Entrepise	(2A/C)	09.98 - 12.12		34B	∅	OIL	200588	100588.1	100588.2	600101	600102	516004
				34B	∅	GAS	210588	110588.1	110588.2			
				∅	OIL	201726	101726.0			-		
				∅	GAS	211726	111726.0			-		

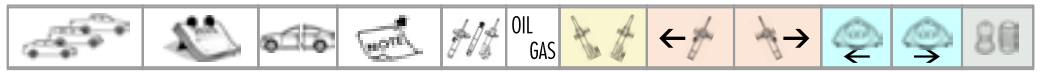

PEUGEOT (F)

1.4 HDi, 2.0 HDi incl. Entreprise	(2A/C)	12.99 - 09.09				OIL	200588	100588.1	100588.2	600101	600102	516004	
						GAS	210588	110588.1	110588.2				
						N.D.		OIL	201726	101726.0			-
						N.D.		GAS	211726	111726.0			-
2.0 16V	(2A/C)	04.99 - 12.07				GAS	210586	110586.1	110586.2	600101	600102	516004	
						GAS	211727	111727.0			-		
						GAS	210586	110586.1	110586.2	600101	600102	516004	
CC	(2D)	09.00 - 12.07				GAS	211727	111727.0			-		
						GAS	210586	110586.1	110586.2	600101	600102	516004	
SW	(2E/K)	07.02 -				OIL	200588	100588.1	100588.2	600101	600102	516004	
						GAS	210588	110588.1	110588.2	600101	600102	516004	
						N.D.		OIL	201726	101726.0			-
						N.D.		GAS	211726	111726.0			-
						GAS	211727	111727.0			-		

206 +

Plus	(2L, 2M)	01.09 - 08.13				GAS	210588	110588.1	110588.2	600101	600102	516004
						GAS	211726	111726.0			-	

207

	(WA, WC, WD, WK)	02.06 - 12.15		11B		GAS	210594	110594.1	110594.2			516004
				11A		GAS	210593	110593.1	110593.2			516004
						GAS	211732	111732.0			-	

208

Excl. GTi	(CA, CC)	03.12 -		11B		GAS	210598	110598.1	110598.2			516004
				11A		GAS	210599	110599.1	110599.2			516004
						GAS	211737	111737.0			-	

208 II *NEW*

	(UB, UP, UW, UJ)	06.19 -										

301

		04.14 -				GAS	210604	110604.1	110604.2			516004
						GAS	211741	111741.0			-	

304

	(04M, 04D)	10.69 - 02.70										
						OIL	201133	101133.0				
	(04M, 04D)	03.70 - 06.72				OIL	200048	100048.0				
						OIL	201133	101133.0				
	(04M, 04D)	07.72 - 08.77				OIL	200048	100048.0				
						OIL	201134	101134.0				
	(04M, 04D)	08.77 - 10.79				OIL	200049	100049.0				
						OIL	201134	101134.0				
S > Ch. 329800	(04C)	03.70 - 02.73				OIL	200048	100048.0				
						OIL	201133	101133.0				
S Ch. 329801 >	(04C)	03.73 - 04.75				OIL	200048	100048.0				
						OIL	201134	101134.0				

PEUGEOT (F)

	(04B)	03.70 - 06.72			/	OIL	200048	100048.0			
	(04B)	07.72 - 07.76			/	OIL	200048	100048.0			
					/	OIL	201134	101134.0			

305

GL, GR, SR, GLS, GLD, GRD, S, SRD > Ch. 8870212	(581A, 581M)	01.77 - 12.82			/	OIL	200049	100049.0			
					/	OIL	201135	101135.0			
GL, GR, SR, GLS, GLD, GRD, SRD Ch. 8870212 > 8987000	(581A, 581M)	01.82 - 06.82			/	OIL	200049	100049.0			
					/	OIL	201136	101136.0			
GR, SR, GL, GLS (1.1, 1.3, 1.5)	(581A, 581M)	07.82 - 12.85			/	OIL	200578	100578.0			
GLD, GRD, SRD Ch. 8987001 >		07.82 - 07.90			/	OIL	201136	101136.0			
GL, GLS (1.6) Ch. 9370001 >	(581A, 581M)	01.85 - 07.90			/	OIL	200578	100578.0			
					/	OIL	201137	101137.0			
> Ch. 8987000	(581D, 581E)	01.78 - 06.82			/	OIL	200049	100049.0			
					/	OIL	201042	101042.0			
Ch. 8987001 >	(581D, 581E)	07.82 - 07.90			/	OIL	200578	100578.0			
					/	OIL	201042	101042.0			

306

1.1	(7A, 7B, 7C, N3, N5)	01.93 - 08.01			/	GAS	210210	110210.1	110210.2	600110	516004
					/	OIL	201344	101344.0			-
					/	GAS	211709	111709.0			-
1.4 (4 m)	(7A, 7B, 7C, N3, N5)	06.94 - 05.01			/	GAS	210210	110210.1	110210.2	600110	516004
					/	OIL	201344	101344.0			-
					/	GAS	211709	111709.0			-
1.4 (3/5 m) excl. 175/70x13" excl. 175/65x14"	(7A, 7B, 7C, N3, N5)	01.93 - 08.01			/	GAS	210210	110210.1	110210.2	600110	516004
					/	N.D.	201344	101344.0			-
					/	N.D.	211709	111709.0			-
					/	H.D.	211708	111708.0			-
1.4 (3/5 m) 175/70x13" 175/65x14"	(7A, 7B, 7C, N3, N5)	01.93 - 08.01			/	GAS	210210	110210.1	110210.2	600110	516004
					/	N.D.	201344	101344.0			-
					/	N.D.	211709	111709.0			-
					/	H.D.	211708	111708.0			-
1.6, 1.8 1.8 D, 1.9 D, 1.9 TD, 2.0 HDi	(7A, 7B, 7C, N3, N5)	01.93 - 08.01			/	GAS	210210	110210.1	110210.2	600110	516004
					/	N.D.	201344	101344.0			-
					/	N.D.	211709	111709.0			-
					/	H.D.	211708	111708.0			-
2.0, 2.0 16V	(7A, 7B, 7C, N3, N5)	01.93 - 08.01			/	GAS	210210	110210.1	110210.2	600110	516004
					/	GAS	211708	111708.0			-
	(7E, N3, N5)	06.94 - 04.02			/	GAS	210210	110210.1	110210.2	600110	516004
					/	GAS	211708	111708.0			-
	(7D, N3, N5)	03.94 - 04.02			/	GAS	210210	110210.1	110210.2	600110	516004
					/	GAS	211709	111709.0			-
Entreprise		01.93 - 05.99			/	GAS	210210	110210.1	110210.2	600110	516004
					/	OIL	201344	101344.0			-
					/	GAS	211709	111709.0			-

PEUGEOT (F)

307

1.4, 1.6, 2.0, 2.0 HDi Excl. Commercial,	(3A/C)	08.00 - 11.07				GAS	210589	110589.1	110589.2	600090	516004
					GAS	211729	111729.0				
1.4 HDi, 1.6 HDi Excl. Commercial,	(3A/C)	10.01 - 03.09				GAS	210590	110590.1	110590.2	600090	516004
					GAS	211729	111729.0				
Commercial 	(3A/C)	08.00 - 11.07 08.00 - 11.07				GAS	210590	110590.1	110590.2	600090	516004
					GAS	211729	111729.0				
SW Excl. Commercial,	(3E, 3H)	03.02 - 12.09				GAS	210589	110589.1	110589.2	600090	516004
					GAS	211729	111729.0				
SW Commercial SW	(3E, 3H)	03.02 - 12.09 03.02 - 12.09				GAS	210590	110590.1	110590.2	600090	516004
					GAS	211730	111730.0				
	(3B)	10.03 - 04.09				GAS	210589	110589.1	110589.2	600090	516004

308

	(4A, 4C)	09.07 - 10.14				GAS	210595	110595.1	110595.2		516004
					GAS	211733	111733.0				
	(4E, 4H)	09.07 - 10.14				GAS	210595	110595.1	110595.2		516004
					GAS	211734	111734.0				
	(4B)	04.09 - 12.14				GAS	210595	110595.1	110595.2		516004
					GAS	211734	111734.0				

308 II

 excl. 1.6 THP, 1.6 GT 205, 1.6 Gti, 2.0 GT Hdi,	(LB, LP, LW, LH, L3)	09.13 -				GAS	210603	110603.0			516004
					GAS	211740	111740.0				
 excl. 1.6 THP, 1.6 GT 205, 1.6 Gti, 2.0 GT Hdi,	(LC, LJ, LR, LX, L4)	09.13 -				GAS	210603	110603.0			516004
					GAS	211740	111740.0				

309

1.1, 1.3, 1.4, 1.8 D, 1.9 D 1.6 (XU5), 1.9 (XU9) excl. GTI, GTI 16V	(10C, 10A, 3C, 3A)	10.85 - 12.93 10.85 - 10.89				OIL	200575	100575.0			516004	
				N.D.		OIL	201344	101344.0				-
				N.D.		GAS	211709	111709.0				-
1.6 (XU5) excl. GTI 1.9 (XU9) excl. GTI, GTI 16V 1.8 TD (XUD7T)	(10C, 10A, 3C, 3A)	11.89 - 12.93 08.88 - 12.93 08.89 - 12.93				OIL	200577	100577.1	100577.2		516004	
				N.D.		OIL	201344	101344.0				-
				N.D.		GAS	211709	111709.0				-
1.6i (XU5JA) 1.9 GTI, GTI 16 (XU9J, XU9JA)	(10C, 10A, 3C, 3A)	08.88 - 12.93 10.86 - 12.93				OIL	200576	100576.1	100576.2		516004	
					GAS	211708	111708.0				-	

405

1.4, 1.6, 1.8, 1.9 D (GL, GR, SR)	(15B, 4B)	01.87 - 10.95				GAS	210579	110579.0			516004	
						OIL	201713	101713.0				-
						GAS	211713	111713.0				-
1.9 GRi, SRi, STi	(15B, 4B)	01.87 - 10.95				GAS	210580	110580.0			516004	
						OIL	201713	101713.0				-
						GAS	211713	111713.0				-
1.9 MI-16 excl. 4X4	(15B, 4B)	1987 - 10.95				GAS	210580	110580.0			516004	
											-	

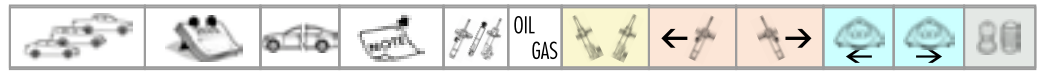

PEUGEOT (F)

GRX4, SRX4	(15B, 4B)	01.89 - 10.95			GAS	210579	110579.0			516004
2.0 MI-16, 2.0 T16 4X4	(15B, 4B)	01.89 - 10.95			GAS	210580	110580.0			516004
1.8 TD	(15B, 4B)	03.88 - 10.95			GAS	210580	110580.0			516004
					OIL	201713	101713.0			-
1.4, 1.6, 1.8, 1.9 D excl. 4X4	(15E, 4E)	10.88 - 10.96			GAS	210579	110579.0			516004
					OIL	201713	101713.0			-
					GAS	211713	111713.0			-
Entreprise excl. 4X4	(15E, 4E)	10.88 - 10.96			GAS	210580	110580.0			516004
										-
1.9 GRi, SRi, STi, 1.8 TD excl. 4X4	(15E, 4E)	10.88 - 10.96			GAS	210580	110580.0			516004
					OIL	201713	101713.0			-
					GAS	211713	111713.0			-
4X4	(15E, 4E)	10.88 - 10.96			GAS	210580	110580.0			516004

406

1.6, 1.8, 2.0 1.9 D, 1.9 TD, 2.0 HDi	(8B)	10.95 - 05.04			GAS	210582	110582.1	110582.2			516004
					GAS	211721	111721.0			516001	
2.0 Turbo 2.1 TD, 2.2 HDi	(8B)	10.95 - 05.04			GAS	210582	110582.1	110582.2			516004
					GAS	211721	111721.0			516001	
3.0 V6 excl.	(8B)	10.95 - 05.04			GAS	210583	110583.1	110583.2			516004
					GAS	211721	111721.0			516001	
1.6, 1.8, 2.0 1.9 D, 1.9 TD, 2.0 HDi	(8E/F)	10.96 - 10.04			GAS	210582	110582.1	110582.2			516004
					GAS	211721	111721.0			516001	
2.0 Turbo 2.1 TD, 2.2 HDi	(8E/F)	10.96 - 10.04			GAS	210582	110582.1	110582.2			516004
					GAS	211723	111723.0			516001	
3.0 V6 excl.	(8E/F)	10.96 - 10.04			GAS	210583	110583.1	110583.2			516004
					GAS	211723	111723.0				
2.0, 2.2, 3.0 V6 excl. 2.2 HDi excl.	(8C)	03.97 - 12.04			GAS	210583	110583.1	110583.2			516004
					GAS	211724	111724.0			516010	

407

	(6D)	05.04 - 02.11			GAS	211138	111138.0			
					GAS	211139	111139.0			
	(6E)	05.04 - 12.10			GAS	211138	111138.0			
					GAS	211139	111139.0			
	(6C)	10.05 -			GAS	211140	111140.0			
					GAS	211141	111141.0			

504

L, LD > Ch. 2181356		01.73 - 12.76			OIL	200050	100050.0			
					OIL	201710	101710.0			
GL, TI, GLD > Ch. 2181356		07.68 - 12.76			OIL	200050	100050.0			
					OIL	201715	101715.0			
L, LD, GR, GRD, SR, SRD Ch. 2181357 >		01.76 - 12.80								
					OIL	201710	101710.0			

PEUGEOT (F)

GL, TI, GLD Ch. 2181357 >		01.76 - 12.86			/								
					∅	OIL	201715	101715.0					
L, GL, LD, GLD > Ch. 2181356		01.72 - 12.76			/	OIL	200050	100050.0					
					∅	OIL	201711	101711.0					-
L, GL, GR, LD, GLD, GRD Ch. 2181357 >		01.76 - 07.86			/								
					∅	OIL	201711	101711.0					-
> Ch. 2085065		01.68 - 12.76			/	OIL	200050	100050.0					
					∅	OIL	201715	101715.0					
> Ch. 2085066 >		01.76 - 08.84			/								
					∅	OIL	201715	101715.0					
(U01, U20)	(U01, U20)	01.80 - 05.85		N.D.	∅	OIL	201712	101712.0					-
					∅	OIL	201712	101712.0					-
Ch. 3972016 >	(U01, U20)	06.85 - 12.89			/	OIL	200052	100052.0					
				N.D.	∅	OIL	201712	101712.0					-

505

excl. 2.2 Turbo > Ch. 1845000	(551A)	05.79 - 12.85			/								
2.2 Turbo > Ch. 1887751		03.84 - 12.86			∅	OIL	201715	101715.0					
excl. 2.8 V6, 2.2 Turbo Ch. 1845001 >	(551A)	01.86 - 12.93			/	OIL	200053	100053.0					
2.2 Turbo excl. ABS Ch. 1887752 >		01.87 - 12.93			∅	OIL	201715	101715.0					
2.8 V6, 2.2 Turbo ABS Ch. 1965001 >	(551A)	01.87 - 12.93			/								
					∅	OIL	201715	101715.0					
> Ch. 1845000	(551D)	04.82 - 12.85			/								
					∅	OIL	201716	101716.0					-
Ch. 1845001 >	(551D)	01.86 - 12.93			/	OIL	200053	100053.0					
					∅	OIL	201716	101716.0					-

508

> Ch. 1845000	(8D, 8E)	11.10 - 12.18				GAS	210600	110600.1	110600.2				516004
excl. Hybrid excl.						GAS	211142	111142.0					

508 II *NEW*

excl. Hybrid excl.	(FB, FH, F3)					GAS	212224	112224.0					516004
						GAS							
excl. Hybrid excl.	(FC, FJ, F4)					GAS	212224	112224.0					516004
						GAS							

604

excl. 2.8 GTI	(561A)	01.74 - 07.87			/								
				excl.	∅	OIL	201715	101715.0					

605

excl.	(6B)	10.89 - 09.99				GAS	210581	110581.1	110581.2				516004
					∅	GAS	211717	111717.0					-











607

excl.	(9D, 9U)	02.00 - 07.11				GAS	210587	110587.1	110587.2				516004
					∅	GAS	211728	111728.0					-







PEUGEOT (F)





806

	(221)	03.94 - 12.97				GAS	210270	110270.0	600741	600742	516004
				18A		GAS	211401	111401.0			-
	(221)	01.98 - 08.02				GAS	210270	110270.0	600741	600742	516004
				18B		GAS	211351	111351.0			-







807

	(E)	06.02 -				GAS	210447	110447.1	110447.2	600741	600742	516004
						GAS	211289	111289.0			-	



1007

	1.4, 1.6-16V, 1.4 HDI	(KM)	04.05 -				GAS	210212	110212.1	110212.2	600230	516004
							GAS	211353	111353.0			-





2008

	(CU)	03.13 -		11B		GAS	210601	110601.1	110601.2			516004
				11A		GAS	210602	110602.1	110602.2			516004
						GAS	211739	111739.0			-	





2008 II *NEW*

	(U)	08.19 -										
												





3008

	, excl. Hybrid	(OU)	06.09 - 08.16				GAS	210596	110596.1	110596.2			516004
							GAS	211735	111735.0				





3008 SUV *NEW*

	, excl. Hybrid	(M)	05.16 -				GAS	212212	112212.0			516004
							GAS	212213	112213.0			





4007

	2.4 16V, 2.2 HDi	(VU, VV)	02.07 - 03.13				GAS	210225	110225.1	110225.2			516004
							GAS	211358	111358.0				





4008

			05.12 - 08.13				GAS	210538	110538.1	110538.2			516004
							GAS	211121	111121.0				

5008

		(OU, OE)	09.09 - 03.17				GAS	210597	110597.1	110597.2			516004
							GAS	211736	111736.0			-	





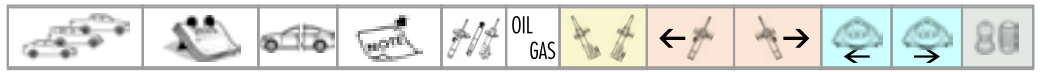





5008 II *NEW*

			12.16 -				GAS	212212	112212.0			
							GAS	212213	112213.0			-

































































PEUGEOT (F)





































BIPPER

 N.D. Finestrato	(AA)	04.08 -			GAS	210173	110173.1	110173.2	600541	600542	516004
					GAS	211305	111305.0				-
 H.D. Cassonato	(AA)	02.08 -			GAS	210173	110173.1	110173.2	600541	600542	516004
					GAS	212012	112012.0				-

BOXER

 1000 Kg, 1400 Kg	(230L)	02.94 - 04.02		15B		OIL	200265	100265.0		600071	600072	516007
						GAS	210265	110265.0				
				14D		OIL	201398	101398.0				-
						GAS	211398	111398.0				-
 1800 Kg	(230L)	02.94 - 04.02		15B		OIL	200280	100280.0		600071	600072	516007
						GAS	210280	110280.0				
				14E		OIL	201405	101405.0				-
						GAS	211405	111405.0				-
 COMBI	(230P)	02.94 - 04.02		15B		OIL	200265	100265.0		600071	600072	516007
						GAS	210265	110265.0				
	(244)	04.02 - 05.06		15B		OIL	200265	100265.0		600071	600072	516007
						GAS	210265	110265.0				
	14D		GAS	211398	111398.0				-			
											516007	
	(244, Z)	04.02 - 05.06										
												-
 1000Kg 1400Kg		04.06 -		15Ca		GAS	210881	110881.0		600651	600652	516007
						GAS	211296	111296.0				
	14F		GAS	211296	111296.0				-			
											516007	
 1400Kg 2000Kg		04.06 -		15Ca		GAS	210882	110882.0		600651	600652	516007
						GAS	211301	111301.0				
	14G		GAS	211301	111301.0				-			
											516007	
 1000Kg 1400Kg REINFORCED		04.06 -		15Cb		GAS	210159	110159.0		600651	600652	516007
						GAS	211296	111296.0				
	14F		GAS	211296	111296.0				-			
											516007	
 1400Kg 2000Kg REINFORCED		04.06 -		15Cb		GAS	210167	110167.0		600651	600652	516007
						GAS	211301	111301.0				
	14G		GAS	211301	111301.0				-			
											516007	

























EXPERT

 (> Ch. 7609)	(222, 223, 224)	07.95 - 12.97			GAS	210270	110270.0		600741	600742	516004
				18A		GAS	211401	111401.0			
 (Ch. 7610 > 9793)	(222, 223, 224)	01.98 - 08.03			GAS	210270	110270.0		600741	600742	516004
				18B		GAS	211351	111351.0			
 (Ch. 9794 > 10408)		10.03 - 05.04			GAS	210166	110166.1	110166.2	600741	600742	516004
				18B		GAS	211351	111351.0			
 (Ch. 10409 >)		05.04 - 2006			GAS	210270	110270.0		600741	600742	516004
				18B		GAS	211351	111351.0			
 1.6D, 2.0 D	(VF3X)	01.07 -			GAS	210169	110169.1	110169.2	600741	600742	516004
				18C		GAS	211303	111303.0			
 1.6D, 2.0 D H.D.	(VF3X)	01.07 -			GAS	210170	110170.1	110170.2	600741	600742	516004
				18D		GAS	211304	111304.0			
 *NEW*	(V)	04.16 -			GAS	212164	112164.0				
						GAS	212165	112165.0			
											







PEUGEOT (F)





J5

 Ch. > 0244300	(280L, 280P)	09.81 - 12.85		15A		OIL	200206	100206.0			516004
				14G		OIL	201347	101347.0			-
 Ch. 0244301 >	(280L, 280P, 290L, 290P)	01.85 - 12.94		15A		OIL	200207	100207.0			516004
				14G		OIL	201347	101347.0			-
 excl. 1800kg	(280L)	09.81 - 12.84		15A		OIL	200206	100206.0			516004
				14G		OIL	201347	101347.0			-
 excl. 1800kg	(280L)	01.85 - 12.87		15A		OIL	200207	100207.0			516004
				14G		OIL	201347	101347.0			-
 excl. 1800kg	(280L, 290L)	01.88 - 12.94		15A		OIL	200207	100207.0			516004
				14B		OIL	201348	101348.0			-





J7

		01.66 - 03.80				OIL	201719	101719.0			
						OIL	201718	101718.0			





















J9

		03.80 - 12.94				OIL	201719	101719.0			
						OIL	201718	101718.0			





P4

						GAS	211540	111540.0			
						GAS	211541	111541.0			





PARTNER / RANCH

 excl. 4X4	(5, 5F)	06.96 - 11.02				GAS	210210	110210.1	110210.2	600110	516004
						OIL	201713	101713.0			-
	(G)	11.02 - 12.15				GAS	211713	111713.0			-
						GAS	210588	110588.1	110588.2	600101	600102
		04.08 -				GAS	210224	110224.1	110224.2	600090	516004
						GAS	211357	111357.0			-
 *NEW*	(K9)	09.18 -				GAS	212224	112224.0			516004
						GAS	212225	112225.0			-

RIFTER *NEW*

		09.18 -				GAS	212224	112224.0			516004
						GAS	212225	112225.0			-





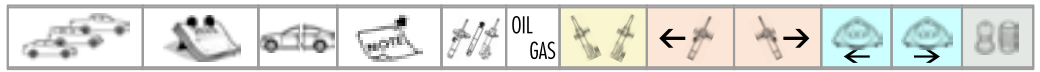



























TRAVELLER *NEW*

	(V)	04.16 -				GAS	212164	112164.0			516004
						GAS	212165	112165.0			-







PIAGGIO (I)

PORTER





 excl. 16V		02.93 -			OIL	200920	100920.1	100920.2			
					OIL	202041	102041.0				
 16V		05.98 -			OIL	200920	100920.1	100920.2			
											
 excl. 16V		02.93 -			OIL	200919	100919.1	100919.2			
					OIL	202041	102041.0				
 16V		05.98 -			OIL	200919	100919.1	100919.2			
											
  maxxi, Quargo 4WD, 1100 kg, ribaltabile		06.98 -			GAS	210922	110922.1	110922.2			
					OIL	202041	102041.0				
  euro 5	(D120)	01.11 -			GAS	210921	110921.1	110921.2			
					OIL	202042	102042.0				

POLSKI (PL)





100

101 P Zastava					OIL	200243	100243.0			
					OIL	200244	100244.0			





125

 , 		1968 - 1978			OIL	201378	101378.0			
										





126

					OIL	201380	101380.0			
					OIL	201381	101381.0			





127

					OIL	200240	100240.0			
					OIL	200134	100134.0			

132

					OIL	201378	101378.0			
					OIL	201384	101384.0			



FSO

Polonez 1500, 1600, Atou, Caro		06.78 - 07.93			OIL	201378	101378.0			
										





PORSCHE (D)



356

 A, B, C, SC		01.56 - 12.65			⊘	OIL	201666	101666.0			
					⊘						

924



















		11.75 - 12.85			/	GAS	210082	110082.0			
					⊘	GAS	211743	111743.0			

944







		06.81 - 07.84			/	GAS	210082	110082.0			
					⊘	GAS	211743	111743.0			

RENAULT (F)





















R 4

	(R112_)	01.61 - 08.68			♂							
					♀	OIL	201745	101745.0				
	(R112_)	09.68 - 12.93			♂	OIL	201746	101746.0				
					♀	OIL	201745	101745.0				
 GTL, Rodeo	(R1128)	01.73 - 12.93			♂	OIL	201746	101746.0				
					♀	OIL	201745	101745.0				
	(R2102/4/5/6)	01.61 - 08.68			♂							
					♀							
 F4	(R2105/6/8/9) R2391/2)	09.68 - 12.93			♂	OIL	201746	101746.0				
					♀							
 F6	(R2340/70) R2430)	01.75 - 12.93					201746	101746.0				
												



R 5

 excl. Alpine	-122	02.72 - 09.84			♂	OIL	201746	101746.0				
					♂	OIL	201748	101748.0				
 (R1223/122 B) Alpine	(R1223/122 B)	03.76 - 09.84			♂	OIL	201749	101749.0				
					♂	OIL	201750	101750.0				













SUPER 5

 excl. GT Turbo / GTE	(B, C, S)	09.84 - 05.88		35A	↘	OIL	200605	100605.0				516004
					∞	OIL	201751	101751.0				-
 excl. GT Turbo, GTE	(B, C, S)	06.88 - 12.96		35A	↘	OIL	200605	100605.0				516004
					∞	OIL	201751	101751.0				-
 excl. GT Turbo, GTE	(B, C, S)	06.88 - 12.96		35B	↘	OIL	200606	100606.0				516004
												
 GTE	(C409)	01.87 - 12.96			↘	OIL	200607	100607.0				516004
					∞	GAS	211752	111752.0				-
 1.4 GT Turbo	(C405)	09.84 - 07.85			↘							516004
					∞	GAS	211752	111752.0				-
 1.4 GT Turbo	(C405)	08.85 - 05.87			↘	OIL	200607	100607.0				516004
					∞	GAS	211752	111752.0				-
 1.4 GT Turbo	(C405)	06.87 - 05.91			↘	OIL	200608	100608.0				516004
					∞	GAS	211752	111752.0				-

R 6

	(R1180, R1181)	01.68 - 04.87			♂	OIL	201746	101746.0				
					♀	OIL	201745	101745.0				







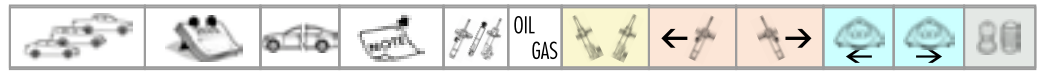



R 9

 1.1, 1.2, 1.4, 1.6 D	(L 42_)	09.81 - 12.89			↘	OIL	200610	100610.0				516004
				t	♂	OIL	201754	101754.0				
 1.7 > Ch. D00000525	(L 42 F/L/N)	09.84 - 12.86			↘	OIL	200610	100610.0				516004
				t	♂	OIL	201754	101754.0				
 1.7 > Ch. D00003950, > Ch. H00005600	(L 426)	09.84 - 12.86			↘	OIL	200610	100610.0				516004
				t	♂	OIL	201754	101754.0				
 1.7 Ch. D00000526 >	(L 42 F/L/N)	01.86 - 12.88			↘	OIL	200610	100610.0				516004
				q	♂	OIL	201755	101755.0				



















































RENAULT (F)

 1.7 Ch. D00003951 >, Ch. H00005601 >	(L 426)	01.86 - 12.88				OIL	200610	100610.0			516004
				q		OIL	201755	101755.0			
 1.7 GTE, 1.4 Turbo	(L 42E, L425)	04.84 - 12.89				OIL	200610	100610.0			516004
				q		OIL	201755	101755.0			







R 11

 1.1, 1.2, 1.4, 1.6 D	(B/C/S 37_) 37 S, 37 J)	03.83 - 07.89				OIL	200610	100610.0			516004
				t		OIL	201754	101754.0			
 1.7 > Ch. D00043789 > Ch. H00017726 > Ch. D00006418	(B/C 376)	10.83 - 12.86				OIL	200610	100610.0			516004
				t		OIL	201754	101754.0			
 1.7 > Ch. D00000644 > Ch. D00000509	(B/C 37 F/L/N)	10.84 - 12.86				OIL	200610	100610.0			516004
				t		OIL	201754	101754.0			
 1.4 Turbo > Ch. D00001343 > Ch. D00007886 > Ch. E00002300	(B/C 375)	04.84 - 12.86				OIL	200610	100610.0			516004
				t		OIL	201754	101754.0			
 1.7 Ch. D00043790 > Ch. H00017727 > Ch. D00006419 >	(B/C 376)	01.86 - 12.87				OIL	200610	100610.0			516004
				q		OIL	201755	101755.0			
 1.7 Ch. D00000645 > Ch. D00000510 >	(B/C 37 F/L/N)	01.86 - 12.88				OIL	200610	100610.0			516004
				q		OIL	201755	101755.0			
 1.7	(B 37E, C37E)	01.86 - 12.88				OIL	200610	100610.0			516004
				q		OIL	201755	101755.0			
 1.4 Turbo excl. Zender Ch. D00001344 > Ch. D00007887 > Ch. E00002301 >	(B/C 375)	01.86 - 12.88				OIL	200610	100610.0			516004
				q		OIL	201755	101755.0			



R 12

		10.69 - 04.70									
					+	OIL	201756	101756.0			
		05.70 - 08.80									
					+	OIL	201756	101756.0			

R 14



 > Ch. 345946, > Ch. 7533	(R1210, R1211)	05.76 - 12.78			/	OIL	200023	100023.0			
					o	OIL	201748	101748.0			
 Ch. 345947 >, Ch. 7534 >	(R1210/1/2/3)	01.78 - 12.83			/	OIL	200055	100055.0			
					o	OIL	201748	101748.0			

R 15



 TL, TS	(R1300, R1302)	10.71 - 10.80			/	OIL	201143	101143.0			516010
					+	OIL	201756	101756.0			

RENAULT (F)













R 16

	(R115)	09.65 - 08.80			∅	OIL	201757	101757.0			
					∅	OIL	201758	101758.0			

R 17

 TL, TS	(R1301 > R1328)	04.72 - 10.80			∅	OIL	201143	101143.0			
					+	OIL	201756	101756.0			

R 18

 TS, GTS > Ch. 10709	(R1342)	04.78 - 12.82			∅	OIL	201146	101146.0			
					+	OIL	201759	101759.0			
 TL, GTL > Ch. 552000  TS, GTS, GTL > Ch. 559400  TS, GTS Ch. 10709 > 20609  TL	(R1340) (R1341) (R1342) (R1349)	04.78 - 12.84 04.78 - 12.84 04.78 - 12.84 04.78 - 12.82			∅	OIL	201144	101144.0			
					+	OIL	201759	101759.0			
					∅	OIL	201145	101145.0			
 TL, GTL Ch. 552001 >  TS, GTS, GTL Ch. 559401 >  TS, GTS Ch. 20610 >	(R1340) (R1341) (R1342)	01.84 - 07.86 01.84 - 07.86 01.84 - 07.86			∅	OIL	201145	101145.0			
					+	OIL	201759	101759.0			
 TX, GTX > Ch. 3200  TD, GTD > Ch. 190905	(R1343) (R1344)	04.78 - 12.83 04.78 - 12.84			∅	OIL	201146	101146.0			
					+	OIL	201759	101759.0			
 TX, GTX Ch. 3201 >  TD, GTD Ch. 190906 >	(R1343) (R1344)	01.83 - 07.86 01.84 - 07.86			∅	OIL	201145	101145.0			
					+	OIL	201759	101759.0			
 1.6 Turbo  2.1 D Turbo	(R1345, R134A) (R1346)	10.80 - 07.86 11.81 - 07.86			∅	OIL	201145	101145.0			
					+	OIL	201759	101759.0			
 TL > Ch. 122600  LS, TS, GTS, GTL > Ch. 118200  TS, GTS > Ch. 3929  TL > Ch. 200	(R1350) (R1351) (R1352) (R1359)	05.79 - 12.84 05.79 - 12.84 05.79 - 12.83 05.79 - 12.82			∅	OIL	201144	101144.0			
					+	OIL	201759	101759.0			
 TL Ch. 122601 >  LS, TS, GTS, GTL Ch. 118201 >  TS, GTS Ch. 3930 >  TL Ch. 201 >	(R1350) (R1351) (R1352) (R1359)	01.84 - 07.86 01.84 - 07.86 01.83 - 07.86 12.82 - 07.86			∅	OIL	201145	101145.0			
					+	OIL	201759	101759.0			
 TX, GTX > Ch. 2000  TD, GTD > Ch. 63219	(R1353) (R1354)	05.79 - 12.82 05.79 - 12.84			∅	OIL	201146	101146.0			
					+	OIL	201759	101759.0			
 TX, GTX Ch. 2001 >  TD, GTD Ch. 63220 >	(R1353) (R1354)	01.82 - 07.86 01.84 - 07.86			∅	OIL	201145	101145.0			
					+	OIL	201759	101759.0			
 1.6 Turbo  2.1 D Turbo	(R1355, R135A, R135B) (R1356)	09.82 - 07.86 01.84 - 07.86			∅	OIL	201145	101145.0			
					+	OIL	201759	101759.0			
 Soci�t� 1.4 > Ch. 4600	(R2350)	05.79 - 12.83			∅	OIL	201144	101144.0			
					+	OIL	201759	101759.0			
 Soci�t� 1.4 Ch. 4601 >	(R2350)	01.83 - 07.86			∅	OIL	201145	101145.0			
					+	OIL	201759	101759.0			
 Soci�t� 2.1 D > Ch. 3499	(R2354)	10.81 - 12.83			∅	OIL	201146	101146.0			
					+	OIL	201759	101759.0			
 Soci�t� 2.1 D Ch. 3500 >	(R2354)	01.83 - 07.86			∅	OIL	201145	101145.0			
					+	OIL	201759	101759.0			

RENAULT (F)

R 19

excl. 1.8 16V,	(B/C 53, L53)	05.88 - 12.95			GAS	210611	110611.0					
					OIL	200611	100611.0					
							GAS	211761	111761.0			
							OIL	201765	101765.0			
							GAS	211760	111760.0			
OIL	201760	101760.0										
1.8 16 V	(B/C 53, L53)	05.88 - 12.95			GAS	210627	110627.0					
					GAS	211761	111761.0					
excl. 1.8 16V	(D53, 853)	07.91 - 06.96			GAS	210611	110611.0					
					OIL	200611	100611.0					
							GAS	211761	111761.0			
							OIL	201765	101765.0			
1.8 16V	(D53, 853)	07.91 - 06.96			GAS	210627	110627.0					
					GAS	211761	111761.0					

R 20

1.6 L, TL, GTL > Ch. 187000	(R1271)	10.75 - 12.80			OIL	201147	101147.0			
					OIL	200612	100612.0			
1.6 L, TL, GTL Ch. 187001 >	(R1271)	01.81 - 12.83			OIL	201148	101148.0			
					OIL	200612	100612.0			
2.0 LS, TS	(R1272)	10.75 - 12.80			OIL	201149	101149.0			
					OIL	200612	100612.0			
2.0 LS, TS 2.2 TX	(R1272) (R1279)	01.81 - 12.83 10.80 - 12.83			OIL	201150	101150.0			
					OIL	200612	100612.0			
2.0 LS, TS 2.1 D, 2.1 D Turbo	(R1277) (R1270, R1276)	10.80 - 12.83 10.75 - 12.83			OIL	201148	101148.0			
					OIL	200612	100612.0			

R 21

L, TL, GTL, TS, GTS, RS, TSE	(B/L 48)	03.86 - 06.94			OIL	200613	100613.0			
					OIL	201762	101762.0			
TX, GTX, GTS SD, GSD	(B/L 48)	03.86 - 06.94			OIL	200613	100613.0			-
					OIL	201762	101762.0			
RX, TI, TL, GTX, TXE 4X2 RX, TI, GTX, TXE GTX, TXE TD, GTD TBD, TDX	(B/L 48K) (B/L 483, B/L 489) (L48S) (B/L 486) (B/L 488, 48L)	03.86 - 06.94			OIL	200614	100614.1	100614.2		
					OIL	201762	101762.0			
RX, TI, TL, GTX, TXE 4X2 RX, TI, GTX, TXE TXI 4X2 GTX, TXE TD, GTD GTD TBD, TDX	(B/L 48 K/Y) (B/L 483, 489) (L48Q) (L48S) (B/L 486) (B/L 48V) (B/L 488, 48L)	03.86 - 06.94			OIL	200615	100615.1	100615.2		
					OIL	201762	101762.0			
2.0 Turbo incl. 4X4	(L48S)	04.87 - 10.93								
Nevada Nevada	(K481, K482) (K48E/F/H/M/N)	03.86 - 08.94			OIL	200613	100613.0			
					OIL	201763	101763.0			

RENAULT (F)

Société	(S481/2, S48H)	03.86 - 08.94				OIL	200613	100613.0			
						OIL	201763	101763.0			-
Nevada 4X2	(K480/3/6/8/9) (K48K/V)	03.86 - 08.94				OIL	200614	100614.1	100614.2		
						OIL	201763	101763.0			-
Société	(S486, S48V)	03.86 - 08.94				OIL	200614	100614.1	100614.2		
						OIL	201763	101763.0			-
Nevada 4X2	(K480/3/6/8/9) (K48K/V)	03.86 - 08.94				OIL	200615	100615.1	100615.2		
						OIL	201763	101763.0			-
Société	(S486, S48V)	03.86 - 08.94				OIL	200615	100615.1	100615.2		
						OIL	201763	101763.0			-

R 25

excl. 2.7 V6, 2.8 V6 2.7 V6, 2.8 V6 2.8 V6 excl. Auto., 2.4 V6 Turbo	(B298, B29A) (B293, B29F) (B295)	11.83 - 12.93 11.83 - 08.89 06.87 - 12.92 10.84 - 05.90				OIL	201151	101151.0			
						OIL	200616	100616.0			
2.8 V6 Auto. excl. 2.5 V6 Turbo excl.	(B293, B29F) (B29G)	06.87 - 12.92 01.90 - 12.92									
						OIL	200616	100616.0			

R 30

excl. 2.1 D Turbo		02.75 - 01.84									
						OIL	200612	100612.0			
TS TX > Ch. 22200	(R1273, R1275) (R1278)	02.75 - 01.84 1979 - 1980				OIL	201149	101149.0			
						OIL	200612	100612.0			
TX Ch. 22200 >	(R1278)	1980 - 01.84				OIL	201150	101150.0			
						OIL	200612	100612.0			
2.1 D Turbo	(R1270)	02.82 - 03.86				OIL	201148	101148.0			
						OIL	200612	100612.0			

AVANTIME

	(DEO)	09.01 - 05.03				GAS	210660	110660.1	110660.2			516004
						GAS	211821	111821.0				-











































































































CAPTUR

	(J5, H5)	06.13 -				GAS	210969	110969.0	600731	600732	516004
						GAS	212086	112086.0			516010







CLIO I

1.1 RL, RN 1.1 RC 1.2 RL, RN, RT, NRJ	(B/C/S 571) (3/5 57) (B/C/S 572)	05.90 - 12.93 01.94 - 05.97 05.90 - 05.97		36A 36D		OIL	200617	100617.0			516004
						GAS	210617	110617.0			-
1.2 RL, RN, RT	(B/C/S 57 A/R)	05.90 - 09.92		36B 36D		OIL	200618	100618.0			516004
						GAS	210618	110618.0			-
1.2 RL, RN, RT excl. Auto.	(B/C/S 57 A/R)	10.92 - 12.93		36A 36D		OIL	200617	100617.0			516004
						GAS	210617	110617.0			-
						OIL	201764	101764.0			-
						GAS	211764	111764.0			-



























RENAULT (F)

 1.2 Automatic  1.2 RL, RN, RT  1.2 RL	(B/C/S 57L) (B57L)	10.92 - 12.93		36B 36D		OIL	200618	100618.0			516004
						GAS	210618	110618.0			
		05.90 - 12.93			OIL	201764	101764.0				-
					GAS	211764	111764.0				-
 1.2 RL, RN, RT, Be Bop  1.2 RN, RT  1.2	(B/C/S 57A) (B/C/S 57 R/S) (C/S 572)	01.94 - 05.97		36A 36D		OIL	200617	100617.0			516004
						GAS	210617	110617.0			
		01.94 - 05.97			OIL	201764	101764.0				-
					GAS	211764	111764.0				-
 1.4 RL, RN, RT, Baccara, Automatic  1.4 RN, RT, Baccara, Automatic	(B/C 57B) (B/C 573, 57T)	05.90 - 09.92		36B 36D		OIL	200618	100618.0			516004
						GAS	210618	110618.0			
		05.90 - 09.92			OIL	201764	101764.0				-
					GAS	211764	111764.0				-
 1.4 RL, RN, RT, Baccara excl. Auto.  1.4 RN, RT, Baccara excl. Auto.	(B/C 57B) (B/C 573, 57T)	10.92 - 12.93		36A 36D		OIL	200617	100617.0			516004
						GAS	210617	110617.0			
		10.92 - 12.93			OIL	201764	101764.0				-
					GAS	211764	111764.0				-
 1.4 Automatic  1.4 S  1.4 RTi	(B/C 57B, C 57T, C 573) (C57B, C57T)	10.92 - 12.93		36B 36D		OIL	200618	100618.0			516004
						GAS	210618	110618.0			
		05.90 - 12.93			OIL	201764	101764.0				-
					GAS	211764	111764.0				-
 1.4 RL, RN, RT excl. Auto.  1.4 RN, RT, Be Bop excl. Auto.  1.4 RL, RN, RT, Be Bop  1.4 excl. Automatic	(C57B) (B/C 57T) (B/C/S 57Y/7) (C573) (B/C/S 57T)	01.94 - 05.97		36A 36D		OIL	200617	100617.0			516004
						GAS	210617	110617.0			
		01.94 - 05.97			OIL	201764	101764.0				-
					GAS	211764	111764.0				-
 1.4 RL, RN, RT  1.4 S, RTi  1.4 Automatic	(B/5 57B) (C57B) (C 573/57B/57T)	01.94 - 05.97		36B 36D		OIL	200618	100618.0			516004
						GAS	210618	110618.0			
		01.94 - 05.97			OIL	201764	101764.0				-
					GAS	211764	111764.0				-
 1.7 RT, Baccara  1.8 RT, Baccara  1.8 RT  1.8 RT, Baccara	(B/C 574) (B/C 57C) (B 57C) (557D, B578)	01.91 - 12.93		36B 36D		OIL	200618	100618.0			516004
						GAS	210618	110618.0			
		01.94 - 05.97			OIL	201764	101764.0				-
					GAS	211764	111764.0				-
 1.8 RSi	(C57 9/E/H)	01.93 - 05.97									516004
						GAS	211778	111778.0			
 1.8 16V	(C575, C57D)	08.91 - 05.97				GAS	210619	110619.0			516004
						GAS	211793	111793.0			
 1.9 D  1.9 D	(B/C/S 571, B/S 576) (B/C 57U)	01.91 - 12.93		36B 36D		OIL	200618	100618.0			516004
						GAS	210618	110618.0			
		01.91 - 12.93			OIL	201764	101764.0				-
					GAS	211764	111764.0				-
 1.9 D 3m	(C57I, S57I)	01.94 - 05.97		36A 36D		OIL	200617	100617.0			516004
						GAS	210617	110617.0			
		01.94 - 05.97			OIL	201764	101764.0				-
					GAS	211764	111764.0				-
 1.9 D 5 m	(B57I)	01.94 - 05.97		36B 36D		OIL	200618	100618.0			516004
						GAS	210618	110618.0			
		01.94 - 05.97			OIL	201764	101764.0				-
					GAS	211764	111764.0				-
 2.0 16V Williams	(C57M)	01.94 - 09.98									516004
						GAS	211779	111779.0			-

















RENAULT (F)

		05.97 - 03.98		36C		OIL	200633	100633.0			516004
						GAS	210633	110633.0			
					OIL	201764	101764.0			-	
					GAS	211764	111764.0			-	









CLIO II

	1.2, 1.2 16V	(B/C/BO/1)	09.98 -			OIL	200634	100634.0	600390	516004	
						GAS	210634	110634.0			
						OIL	201788	101788.0			
						GAS	211788	111788.0			
	1.4, 1.4 16V, 1.6, 1.5 dCi, 1.9 D, 1.9 dTi	(B/C/BO/1)	09.98 -			OIL	200635	100635.0	600390	516004	
						GAS	210635	110635.0			
						OIL	201788	101788.0			
						GAS	211788	111788.0			
	1.6 16V	(CBOT)	09.98 -			GAS	210637	110637.0	600390	516004	
						GAS	211788	111788.0			
	2.0 RS	(CBOM)	02.00 -			GAS	210644	110644.0		516004	
						GAS	211788	111788.0			
	3.0 V6 RS		11.00 -			GAS	210645	110645.0		516004	
						GAS	211788	111788.0			











CLIO III

	1.2	(BRO/1, CRO/1)	06.05 -			GAS	210655	110655.0	600731	600732	516004
						GAS	211817	111817.0			
	1.4, 1.5 D, 1.6	(BRO/1, CRO/1)	06.05 -			GAS	210655	110655.0	600731	600732	516004
						GAS	211817	111817.0			
	2.0 ☼	(BRO/1, CRO/1)	01.06 -			GAS	210657	110657.0	600731	600732	516004
						GAS	211818	111818.0			
	Grantour excl. ☼	(KRO/1)	02.08 -			GAS	210655	110655.0	600731	600732	516004
						GAS	211817	111817.0			







CLIO IV

	excl. RS	(BH)	11.12 -			GAS	210670	110670.0	600731	600732	516004
						GAS	211829	111829.0			516010
	Grandtour	(KH)	01.13 -			GAS	210670	110670.0	600731	600732	516004
						GAS	211829	111829.0			516010

ESPACE I











2.0 > Ch. T005812	(J112)	07.84 - 12.84								
					GAS	211766	111766.0			
	(J112, J115, J117)	01.85 - 12.87			OIL	201152	101152.0			
					GAS	211766	111766.0			
	excl. □	(J112, J115, J116, J117)	01.88 - 12.90			GAS	211153	111153.0		
						GAS	211766	111766.0		

ESPACE II





	excl. 2.8 V6, Quadra 4X4, □	(J63)	01.91 - 10.96			GAS	211153	111153.0		
						GAS	211766	111766.0		
2.8 V6 excl. Quadra 4X4, □	(J638)	01.91 - 10.96			GAS	211155	111155.0			
					GAS	211766	111766.0			-

RENAULT (F)

























ESPACE III

 excl. Grand Espace	(JE)	11.96 - 10.02		excl. 		GAS	210639	110639.0			516004
						GAS	211785	111785.0			-
 Grand Espace	(JEO)	01.97 - 12.02				GAS	210639	110639.0			516004
						GAS	211823	111823.0			-





ESPACE IV

	(JKO)	11.02 -				GAS	210649	110649.0			516004
						GAS	211805	111805.0			-





EXPRESS / EXTRA / RAPID / COMBI

 excl. CU+ (775Kg)	(F40, G40)	07.85 - 09.96				OIL	200609	100609.0			516004
							GAS	211753	111753.0		
 excl. CU+ (775Kg)	(F40, G40)	10.96 - 03.98				OIL	200636	100636.0			516004
							GAS	211753	111753.0		
 CU+ (775Kg)	(F40, G40)	01.91 - 09.96				OIL	200609	100609.0			516004
							GAS	211781	111781.0		
 CU+ (775Kg)	(F40, G40)	10.96 - 03.98				OIL	200636	100636.0			516004
							GAS	211781	111781.0		











FLUENCE

 , excl. Z.E.	(L3)	02.10 -				GAS	212095	112095.0			516004
						GAS	212096	112096.0			-





















FUEGO

	(136)	02.80 - 10.85				OIL	201145	101145.0			
		02.80 - 10.85				OIL	201759	101759.0			

KADJAR

 excl. 4WD	(HA_, HL_)	06.15 -				GAS	210835	110835.1	110835.2			516004
						GAS	211968	111968.0			-	
 4WD	(HA_, HL_)	06.15 -				GAS	210835	110835.1	110835.2			516004
						GAS	211969	111969.0			-	

KANGOO

 excl. Pampa, CU+ (800 Kg)	(KCO, FCO)	04.98 -				OIL	200631	100631.0	600390		516004
						GAS	210631	110631.0			
						OIL	201786	101786.0			-
						GAS	211786	111786.0			-
 Pampa	(KCO, FCO)	04.98 -				OIL	200654	100654.0	600390		516004
						GAS	210654	110654.0			
						OIL	201816	101816.0			-
						GAS	211816	111816.0			-
 CU+ (800 Kg)	(KCO, FCO)	04.98 -				OIL	200631	100631.0	600390		516004
						GAS	210631	110631.0	600390		
						OIL	201815	101815.0			-
						GAS	211815	111815.0			-
 4X4	(KCO, FCO)	10.01 -				GAS	210668	110668.0	600390		516004
						GAS	211828	111828.0			-

RENAULT (F)

KANGOO II

incl. Express, Grand Kangoo	(KW0/1)	02.08 -		37A		GAS	210666	110666.0			516004
						GAS	211827	111827.0			-
				37B		GAS	210669	110669.0			516004

KOLEOS

2.0 dCi, 2.5 incl 4x4	(HY)	09.08 -				GAS	210665	110665.1	110665.2			516004
						GAS	211826	111826.0			-	

LAGUNA I

1.6 1.8 RN, RT, RXE 2.0 RT, RXE, Baccara 1.9 dTi	(B56 A/B/S/Z) (B56C, B56H)	11.97 - 03.01 12.93 - 02.95 12.93 - 02.95 10.97 - 03.01		38A		OIL	200628	100628.0			516004
						GAS	210628	110628.0			-
						OIL	201780	101780.0			-
						GAS	211780	111780.0			-
3.0 V6 RT, RTI, Baccara 2.2 D, 2.2 dT RN, RT, RXE	(B56E, B56R) (B56F/B562)	12.93 - 03.01		38A		OIL	200628	100628.0			516004
						GAS	210628	110628.0			-
						OIL	201780	101780.0			-
						GAS	211780	111780.0			-
1.6 1.8 RN, RT, RXE 1.8 RN, RT excl. ABS 2.0 excl. ABS, Auto.	(B56 A/B/S/Z) (B56 T/O) (B56 L/C/H)	11.97 - 03.01 02.95 - 03.01 02.95 - 03.01 02.95 - 03.01		38B		OIL	200623	100623.0			516004
						GAS	210623	110623.0			-
						OIL	201780	101780.0			-
						GAS	211780	111780.0			-
1.8 RN, RT ABS 2.0 ABS, Auto. 2.0 RN, RT, RXE, RTI 2.0 ABS	(B56 T/O) (B56L) (B56 D/M) (B56 C/H)	02.95 - 03.01		38A		OIL	200628	100628.0			516004
						GAS	210628	110628.0			-
						OIL	201780	101780.0			-
						GAS	211780	111780.0			-
Nevada excl. 3.0 V6,	(K56)	09.95 - 03.01		38A		OIL	200628	100628.0			516004
						GAS	210628	110628.0			-
				excl.		OIL	201787	101787.0			-
				excl.		GAS	211787	111787.0			-
Nevada 3.0 V6 - excl.	(K56)	02.96 - 03.01		38A		OIL	200628	100628.0			516004
						GAS	210628	110628.0			-
						OIL	200628	100628.0			-
				excl.		GAS	210628	110628.0			-

LAGUNA II

	(BG0/1)	03.01 - 12.07				GAS	210643	110643.0			516004
						GAS	211798	111798.0			-
	(KG0/1)	03.01 - 12.07				GAS	210643	110643.0			516004
						GAS	211799	111799.0			-

LAGUNA III

	(BT0/1, KT0/1)	10.07 - 12.15				GAS	210662	110662.0			516004
						GAS	211824	111824.0			-

LATITUDE

	(L70)	07.10 -				GAS	210970	110970.1	110970.2			516004
						GAS	212087	112087.0			516010	

RENAULT (F)

MASTER Q-SERIES

	(T_, P_)	05.80 - 03.98			⊖	OIL	201774	101774.0			
						OIL	201772	101772.0			-

MASTER R-SERIES

	(R2, R4)	(T_)	05.80 - 03.98			⊖	OIL	201774	101774.0			
							OIL	201773	101773.0			
	(R3) excl. Minicar	(T_)	05.80 - 03.98			+	OIL	201774	101774.0			
	(R3) Minicar	(T_)	05.80 - 02.89			⊖	OIL	201774	101774.0			
	(RC/RD/RL 9)	(P_)	05.80 - 03.98			⊖	OIL	201774	101774.0			
	excl. Minicar	(T_)	03.89 - 03.98			⊖	OIL	201774	101774.0			
	Minicar	(T_)	03.89 - 03.98			+	OIL	201773	101773.0			

MASTER II

	2,8T	(FD, JD)	07.98 - 07.98			⊖	GAS	211789	111789.0			-
							GAS	211789	111789.0			-
	3T, 3,5T	(ED, FD, JD)	07.98 - 07.98			⊖	OIL	201790	101790.0			-
							GAS	211790	111790.0			-
	3,5T	(HD, UD)	07.98 - 07.98			⊖	GAS	211789	111789.0			-
							OIL	201791	101791.0			-

MASTER III

	excl.	(EV, FV, HV, JV, UV)	05.10 - 05.10			⚡	GAS	210875	110875.0			516007
							GAS	212006	112006.0			-
	excl.	(EV, FV, HV, JV, UV)	05.10 - 05.10			⚡	GAS	210875	110875.0			516004
							GAS	212007	112007.0			-
	incl.	(EV, FV, HV, JV, UV)	05.10 - 05.10			⚡	GAS	212118	112118.0			516007
							GAS	212008	112008.0			-

MÉGANE I

	Classic excl. 2.0 16V	(BA)	09.95 - 12.02			⚡	OIL	200629	100629.0			516004
							GAS	210629	110629.0			-
	2.0 16V	(BA)	09.95 - 12.02			⚡	GAS	210630	110630.0			516004
							GAS	211784	111784.0			-
		(KA)	01.98 - 06.99			⚡	OIL	200629	100629.0			516004
							GAS	210629	110629.0			-
		(KA)	07.99 - 08.03			⚡	GAS	210629	110629.0			516004
							GAS	211796	111796.0			-
	excl. 2.0, 2.0 16V	(DAO/1)	10.96 - 12.02			⚡	OIL	200629	100629.0			516004
							GAS	210629	110629.0			-
	2.0, 2.0 16V	(DAO/1)	10.96 - 10.98			⚡	GAS	210630	110630.0			516004
							GAS	211784	111784.0			-

RENAULT (F)

2.0, 2.0 16V	(DAO/1)	11.98 - 12.02			GAS	210641	110641.0			516004
					GAS	211784	111784.0			-
excl. 2.0, 2.0 16V	(EAO)	10.96 - 12.02			OIL	200629	100629.0			516004
					GAS	210629	110629.0			-
2.0, 2.0 16V	(EAO)	10.96 - 10.98			GAS	210630	110630.0			516004
					GAS	211797	111797.0			-
2.0, 2.0 16V	(EAO)	11.98 - 12.02			GAS	210641	110641.0			516004
					GAS	211797	111797.0			-

MÉGANE II

1.4, 1.6, 2.0, 1.5 dCi, 1.9 dCi excl.	(BMO/1, CMO/1)	11.02 - 01.11			GAS	210650	110650.0	600200		516004
					GAS	211812	111812.0			
	(BMO/1, CMO/1)	11.02 - 01.11			GAS	211806	111806.0			
					GAS	211806	111806.0			
1.4, 1.6, 2.0 excl.	(LMO/1)	08.03 -			GAS	210650	110650.0	600200		516004
					GAS	211812	111812.0			
1.5 dCi, 1.9 dCi excl.	(LMO/1)	08.03 -			GAS	210652	110652.0			516004
					GAS	211812	111812.0			
Grandtour 1.4, 1.6, 2.0 excl.	(KMO/1)	09.03 - 08.09			GAS	210650	110650.0	600200		516004
					GAS	211807	111807.0			
Grandtour 1.5 dCi, 1.9 dCi excl.	(KMO/1)	09.03 - 08.09			GAS	210652	110652.0			516004
					GAS	211807	111807.0			
1.6, 2.0, 1.5 dCi, 1.9 dCi	(EMO/1)	09.03 - 08.09			GAS	210652	110652.0			516004
					GAS	211807	111807.0			

MÉGANE III

	(BZO/1, DZO/1, KZO/1)	10.08 -			GAS	210663	110663.0			516004
					GAS	211825	111825.0			

MÉGANE IV *NEW*

	(B9A/M/N, K9A/M/N)	11.15 -			GAS	212195	112195.0			516004
					GAS	211807	111807.0			-

MODUS

	(F/JPO)	12.04 -			GAS	210653	110653.0	600731	600732	516004
					GAS	211814	111814.0			

SAFRANE

excl. 4X4,	(B54)	04.92 - 12.00			GAS	210624	110624.1	110624.2		516004
					GAS	210625	110625.0			516004

SCÉNIC I

1.4 1.6 excl. Auto.	(JAO/1)	11.96 - 06.98 11.96 - 06.98			OIL	200629	100629.0			516004
					GAS	211783	111783.0			-
1.6 Auto., 2.0 1.9 D, 1.9 dT, 1.9 dTi	(JAO/1)	11.96 - 06.98 11.96 - 06.98			OIL	200632	100632.0			516004
					GAS	211783	111783.0			-

RENAULT (F)

excl. RX4	(JA0/1)	06.98 - 06.03			OIL	200629	100629.0			516004
					GAS	210629	110629.0			
RX4 4X4	(JA0/1)	07.00 - 06.03			GAS	211783	111783.0			-
					GAS	210646	110646.0			516004
					GAS	211802	111802.0			-

SCÉNIC II

excl.	(JM0/1)	06.03 - 11.08			GAS	210651	110651.0	600200		516004
					GAS	211808	111808.0			-
Grand Scénic	(JM0/1)	04.04 - 11.08			GAS	210651	110651.0	600200		516004
					GAS	211809	111809.0			-

SCÉNIC III

excl. Grand Scénic	(JZ0/1)	02.09 -			GAS	210667	110667.0			516004
					GAS	211825	111825.0			-
Grand Scénic	(JZ0/1)	02.09 -			GAS	210667	110667.0			516004

SCÉNIC IV *NEW*

excl. Grand Scénic	(J9)	09.16 -			GAS	212197	112197.0			516004
					GAS	211825	111825.0			-
Grand Scénic	(R9)	09.16 -			GAS	212197	112197.0			516004
					GAS	211809	111809.0			-

TALISMAN *NEW*

	(L2M, KP)	06.15 -			GAS	212195	112195.0			516004
					GAS	212196	112196.0			-

THALIA

1.4, 1.4 16V, 1.6 16V, 1.5dCi	(LB)	08.00 -			GAS	210635	110635.0	600390		516004
					OIL	201788	101788.0			516010
					GAS	211788	111788.0			

TRAFIC P-SERIES (RWD) ?v







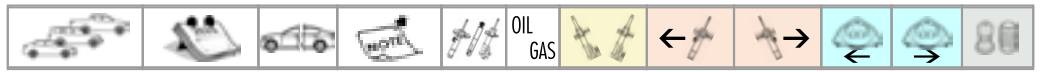





P 3 1000kg P 5/6/8 Microcar		09.80 - 02.89 09.80 - 02.89			OIL	200620	100620.1	100620.2		516007

TRAFIC T-SERIES (FWD) ?u







T 1 800kg excl. Ch. 25270 T 1, T2 T 4, T 5B		09.80 - 02.89 03.89 - 03.01			OIL	200620	100620.1	100620.2		516007
					OIL	201775	101775.0			
T 3 1000kg > Ch. 25270 T 4 1000kg excl. Ch. 25270		09.80 - 02.89 03.89 - 03.01 01.86 - 03.01 09.80 - 03.01 09.80 - 02.89			OIL	200620	100620.1	100620.2		516007
					OIL	201775	101775.0			
T 1 800kg , T 4 1000kg , T 5		09.80 - 02.89			OIL	200620	100620.1	100620.2		516007
					OIL	201776	101776.0			
T 53, TE		03.89 - 03.01			OIL	200620	100620.1	100620.2		516007
					OIL	201776	101776.0			
T 6, T 9 1200kg T 7, TB		01.83 - 12.86 01.86 - 03.01			OIL	200620	100620.1	100620.2		516007
					OIL	201776	101776.0			









RENAULT (F)

T A 1200kg		09.80 - 12.86				OIL	200620	100620.1	100620.2			516007
												
T 4 1000kg lifted body + Ch. 25271>		01.83 - 02.89										516007
						OIL	201775	101775.0				













TRAFIC II

	(JL, FL)	09.01 -				GAS	210648	110648.0	600150		516007
							GAS	211804	111804.0		







TRAFIC III

	(FG, EG)	05.14 -				GAS	212110	112110.0			516007
							GAS	212111	112111.0		







TWINGO

	(C06)	03.93 - 08.00		34A 36D		OIL	200626	100626.0			516004	
						GAS	210626	110626.0				
						OIL	201154	101154.0				
						GAS	211154	111154.0				
	(C06)	09.00 - 08.04				GAS	210642	110642.1	110642.2		516004	
						GAS	211154	111154.0				







TWINGO II

	(CNO)	03.07 -				GAS	210661	110661.0	600390		516004
							GAS	211822	111822.0		







TWINGO III

	(BCM)	09.14 -				GAS	210671	110671.0			516004
							GAS	212094	112094.0		







VEL SATIS

	(BJO)	06.02 -				GAS	210647	110647.0			
							GAS	211803	111803.0		

WIND

	(E4M)	07.10 -				GAS	210971	110971.0			
							GAS	212088	112088.0		





ZOE

	(BFM)	06.12 -				GAS	210972	110972.0			
							GAS	212089	112089.0		







ROVER (GB)





25

 excl.  , ZR, Streetwise	(RF)	10.99 - 05.05				GAS	210676	110676.0			516004
						GAS	211159	111159.0			





45

 1.4, 1.6, 1.8, 2.0, 2.0 iDT excl. 2.5 ZS	(RT)	02.00 - 05.05				GAS	210378	110378.1	110378.2			516004
						GAS	211069	111069.0				

































75

	(RI)	02.99 - 05.05				GAS	210675	110675.1	110675.2			516004
						GAS	211833	111833.0				































100

	(XP)	11.89 - 12.98				OIL	201270	101270.0				
												

200

213, 216	(XH)	06.84 - 09.89				GAS	210355	110355.0			516004	
						GAS	211059	111059.0				
 214, 216  216 GTi, 220 GTi  218 D, 218 TD > Ch. 605481	(XW)	10.89 - 10.95 10.89 - 10.95 10.89 - 10.92				GAS	210364	110364.1	110364.2			516004
						GAS	210365	110365.0				
						GAS	210364	110364.1	110364.2			516004
 218 D, 218 TD Ch. 605482 >	(XW)	10.92 - 10.95				GAS	210364	110364.1	110364.2			516004
						GAS	210365	110365.0				
 214	(XW)	10.92 - 12.95 10.92 - 12.95				GAS	210364	110364.1	110364.2			516004
						GAS	210365	110365.0				
 216	(XW)	10.92 - 12.95				GAS	210364	110364.1	110364.2			516004
						GAS	210365	110365.0				
 211, 214, 216  220 D, SD, SDi	(RF)	10.95 - 03.00 10.95 - 03.00				GAS	210364	110364.1	110364.2			516004
						GAS	211159	111159.0				
 218  200Vi	(RF)	10.95 - 03.00 10.95 - 03.00									516004	
						GAS	211159	111159.0				





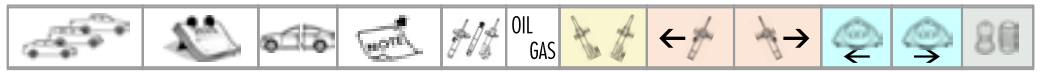









400

 414, 416  418 D > Ch. 605481	(XW)	10.89 - 04.95 10.89 - 10.92				GAS	210364	110364.1	110364.2			516004
						GAS	210365	110365.0				
 420 GSi, 420 SLi  418 D Ch. 605482 >	(XW)	10.92 - 04.95 10.89 - 04.95				GAS	210364	110364.1	110364.2			516004
						GAS	210365	110365.0				
 414, 416	(RT)	05.95 - 03.00				GAS	210378	110378.1	110378.2			516010
						GAS	210365	110365.0				
 420, 420 D, 420 Di	(RT)	05.95 - 03.00				GAS	210378	110378.1	110378.2			516010
						GAS	211069	111069.0				
 Tourer 416 > Ch. 911247	(XW)	10.94 - 02.96				GAS	210364	110364.1	110364.2			516004
						GAS	210365	110365.0				
 Tourer 418 D > Ch. 911247  Tourer 420	(XW)	10.94 - 02.96 10.94 - 02.96				GAS	210364	110364.1	110364.2			516004
						GAS	210365	110365.0				
 Tourer Ch. 911248 >	(XW)	03.96 - 03.00				GAS	210364	110364.1	110364.2			516004
						GAS	210365	110365.0				













ROVER (GB)





600

 excl. 2.0 Turbo, 2.0 D, 2.0 DI > Ch. AM246796	(RH)	04.93 - 02.96				GAS	210350	110350.0			516004
						GAS	210351	110351.0			516004
 excl. 2.0 Turbo, 2.0 D, 2.0 DI Ch. AM246796 >	(RH)	02.96 - 02.99				GAS	210350	110350.0			516004
						GAS	210351	110351.0			516004
 2.0 Turbo, 2.0 D, 2.0 DI	(RH)	02.96 - 02.99									
											





800

		05.86 - 10.91				GAS	211157	111157.0			
						GAS	210672	110672.0			516004
		11.91 - 02.99				GAS	211158	111158.0			
				excl. 		GAS					516004

MGF

 1.6, 1.8	(RD)	03.95 - 03.02				GAS	211831	111831.0			
						GAS	211832	111832.0			

SD1

2000, 2300, 2600, 3500, 2400 Turbo D excl. Vitesse susp.	(SD1)	06.76 - 12.87				OIL	200056	100056.0			
						GAS					



SAAB (S)

90

🚗 > Ch. G6000885		01.60 - 09.84			⊘	OIL	201666	101666.0			-
					⊘	OIL	201834	101834.0			
🚗 Ch. G6000886 >		10.84 - 08.87									
					⊘	OIL	201834	101834.0			

93 / 95 / 96 / 97

93, 93 B		01.56 - 12.59			⊘	OIL	201666	101666.0			-
					⊘	GAS	211367	111367.0			-
🚗 95		10.65 - 12.78			⊘	OIL	201666	101666.0			-
🚗 96 GT 750, 850, 896 sport Sonett 97 sport		10.65 - 08.80 01.60 - 12.66 01.67 - 12.74			⊘	OIL	201666	101666.0			-
					⊘	GAS	211835	111835.0			

99

🚗, 🚗 Combi Coupe 1.7, 1.8, 2.0 🚗, 🚗 2.0 Turbo, GLE		11.67 - 04.78 10.77 - 04.78			⊘	OIL	201666	101666.0			-
					+	OIL	201240	101240.0			
🚗, 🚗 Combi Coupe 2.0, 2.0 Turbo		05.78 - 01.87			⊘	OIL	201666	101666.0			-
					⊘	OIL	201834	101834.0			516010

9-3

🚗	(YS3D)	02.98 - 09.02 02.98 - 08.03			/	GAS	210057	110057.0			516004
					⊘	GAS	211838	111838.0			516010
🚗 excl. 🚗 🚗 excl. 🚗	(YS3F) (YS3F)	09.02 - 02.15 08.03 - 02.15			🚗	GAS	210680	110680.1	110680.2	600770	516004
					⊘	GAS	211839	111839.0			516010

9-5

🚗 2.0, 2.3, 3.0 V6 🚗 Aero 2.3 Turbo	(YS3E)	09.97 - 09.01 09.97 - 09.01			🚗	GAS	210679	110679.1	110679.2		516004
					🚗	GAS	211160	111160.0			
🚗 2.0, 2.3, 3.0 V6 🚗 Aero 2.3 Turbo	(YS3E)	10.98 - 09.01 10.98 - 09.01			🚗	GAS	210679	110679.1	110679.2		516004
					🚗	GAS	211160	111160.0			
🚗 excl. 🚗	(YS3E)	09.01 - 12.09			🚗	GAS	210681	110681.1	110681.2		516004
					🚗	GAS	211160	111160.0			

900 I

🚗, 🚗 Combi Coupe, 🚗 C, GL, GLS, GLi		06.78 - 12.93			⊘	OIL	201836	101836.0			516004
					⊘	OIL	201834	101834.0			516010
🚗, 🚗 Combi Coupe, 🚗 EMS, GLE, Turbo, Turbo 16, CD		06.78 - 12.93			⊘	GAS	211836	111836.0			516004
					⊘	GAS	211834	111834.0			516010
🚗, 🚗 Combi Coupe, 🚗 Turbo 16, Turbo 16 Aero excl. 16 S sport		01.84 - 12.93		39	⊘	GAS	211836	111836.0			516004
					⊘	GAS	211834	111834.0			516010
🚗, 🚗 Combi Coupe, 🚗 Turbo 16, Turbo 16 Aero excl. 16 S sport		01.84 - 12.93			⊘						516004
					⊘	GAS	211834	111834.0			516010





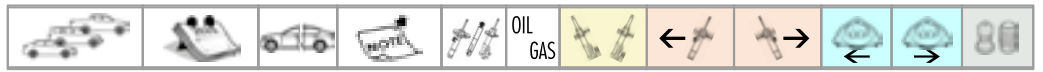









900 II

🚗		07.93 - 02.98			/	GAS	210058	110058.0			516004
					⊘	GAS	211838	111838.0			516010









SAAB (S)

9000







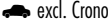

 > Ch. H 8000555		09.84 - 12.87				GAS	210677	110677.0			516004
 > Ch. H 1015469				excl. 		GAS	211837	111837.0			516010
 Ch. H 1015470 >		01.87 - 12.98				GAS	210678	110678.0			516004
 Ch. H 8000556 >				excl. 		GAS	211837	111837.0			516010

SEAT (E)





124

		01.68 - 10.80			o	OIL	201375	101375.0			
					o	OIL	201376	101376.0			
		01.70 - 12.76			o	OIL	201375	101375.0			
					o	OIL	201377	101377.0			-











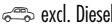



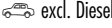



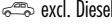











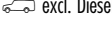



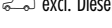

127 / FURA

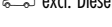
	(127A, 025A)	04.72 - 12.82				OIL	200240	100240.0			
						OIL	200134	100134.0			
Crono		01.82 - 12.86									
						OIL	200134	100134.0			



128

		01.69 - 12.80				OIL	200243	100243.0			
						OIL	200244	100244.0			









131

		12.78 -		12A		OIL	200245	100245.0			
					o	OIL	201376	101376.0			
		01.78 - 09.81		12B		OIL	200246	100246.0			
					o	OIL	201376	101376.0			
		10.81 -		12C		OIL	200247	100247.0			
					o	OIL	201376	101376.0			
		12.78 -		12D		OIL	200248	100248.0			
					o	OIL	201376	101376.0			
		01.79 - 09.81		12E		OIL	200249	100249.0			
					o	OIL	201376	101376.0			
		12.78 -		12A		OIL	200245	100245.0			
					o	OIL	201383	101383.0			-
		01.79 - 09.81		12B		OIL	200246	100246.0			
					o	OIL	201383	101383.0			-
		10.81 -		12C		OIL	200247	100247.0			
					o	OIL	201383	101383.0			-
		01.79 - 09.81		12E		OIL	200249	100249.0			
					o	OIL	201383	101383.0			-

132

		01.73 - 12.82			o	OIL	201378	101378.0			
					o	OIL	201384	101384.0			

ALHAMBRA

	(7V8, 7V9)	04.96 - 03.10				GAS	210314	110314.0	600800	516004
					o	GAS	211429	111429.0		-
	(710, 711)	06.10 -				GAS	210776	110776.0	600430	516004
					o	GAS	211916	111916.0		516010

SEAT (E)

ALTEA/ALTEA XL

excl. , 4X4	(5P)	04.04 -		5A		GAS	210776	110776.0	600430	516004
				5B		GAS	210127	110127.0		
, excl. 4X4	(5P)	04.04 -				GAS	211916	111916.0		516010
				5A		GAS	210777	110777.0	600430	516004
				5B		GAS	210128	110128.0		
						GAS	211260	111260.0		516010

ARONA *NEW*

	(KJ7)	07.17 -				GAS	212240	112240.0		
						GAS	212241	112241.0		

AROSA

	(6H)	05.97 - 06.04		40C		OIL	200771	100771.0	600050	516004			
						GAS	210771	110771.0					
									OIL	201841	101841.0		516010
									GAS	211841	111841.0		

ATECA *NEW*

Assale post. rigido, N.D. excl. , 4x4	(KH7)	04.16 -				GAS	210785	110785.0		516006
						GAS	211924	111924.0		516010
Assale post. rigido, H.D. excl. , 4x4	(KH7)	04.16 -				GAS	210785	110785.0		516006
						GAS	212157	112157.0		516001
Assale post. multilink, N.D. excl. , 4x4	(KH7)	04.16 -				GAS	210785	110785.0		516006
						GAS	211925	111925.0		516010
Assale post. multilink, H.D. excl. , 4x4	(KH7)	04.16 -				GAS	210785	110785.0		516006
						GAS	212217	112217.0		516001

CORDOBA I

excl. 1.8 16V, 2.0 GTI > Ch. 6K#TR80000	(6K2, C2)	02.93 - 12.95		40A		OIL	200768	100768.0	600040	516004			
						GAS	210768	110768.0					
									OIL	201161	101161.0	600700	
									GAS	211161	111161.0		
excl. 1.8 16V, 2.0 GTI Ch. TR80001 > 6K#X#400.000	(6K2, C2)	01.96 - 08.99		40A		OIL	200768	100768.0	600040	516004			
						GAS	210768	110768.0					
									OIL	201161	101161.0	600700	
									GAS	211161	111161.0		
1.8 16V, 2.0 GTI > Ch. 6K-ZR082400 > Ch. 6K-ZR599964	(6K2, C2)	10.93 - 08.99		40A		GAS	210768	110768.0	600040	516004			
						OIL	201162	101162.0	600700				
									GAS	211162	111162.0		
									OIL	201162	101162.0		
1.8 16V, 2.0 GTI Ch. 6K-ZR082401 > Ch. 6K-ZR599965 >	(6K2, C2)	10.93 - 08.99		40B		GAS	210769	110769.0	600040	516004			
						OIL	201162	101162.0	600700				
									GAS	211162	111162.0		
									OIL	201162	101162.0		

CORDOBA II

excl. 1.8 20V Turbo Ch. 6K#X#400.001 >	(6K2)	03.99 - 10.02		40B		GAS	210769	110769.0	600040	516004
						OIL	201163	101163.0	600700	
						GAS	211163	111163.0		



SEAT (E)

1.8 20V Turbo	(6K2)	03.99 - 10.02		40B		OIL	210769	110769.0	600040	516004
						GAS	211163	111163.0	600700	

CORDOBA VARIO

Vario	(6K5)	08.96 - 08.02		40A		OIL	200768	100768.0	600040	516004
						GAS	210768	110768.0		
					OIL	201163	101163.0	600700		
					GAS	211163	111163.0			

CORDOBA III

excl. 1.8 20V Turbo excl. ❏	(6L2)	10.02 - 11.09		N.D. 4A		OIL	200688	100688.0	600350	516004
				N.D. 4A		GAS	210688	110688.0		
				H.D. 4B		GAS	210126	110126.0		
excl. 1.8 20V Turbo ❏	(6L2)	10.02 - 11.09				GAS	211847	111847.0	600290	516010
					4B		GAS	210126	110126.0	
						GAS	211842	111842.0	600290	516010

EXEO

excl. ❏	(3R2)	12.08 - 05.13				GAS	211012	111012.0	600760	
						GAS	211261	111261.0		516010
excl. ❏	(3R5)	06.09 - 05.13				GAS	211012	111012.0	600760	
						GAS	211261	111261.0		516010

IBIZA I







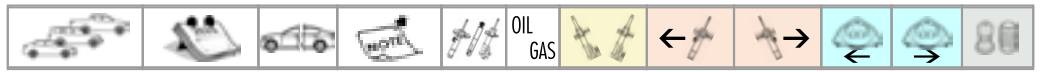

> Ch. 9146536	(021A)	06.84 - 05.86				OIL	200682	100682.0	600570	516004
						GAS	210683	110683.0		516004
Ch. 9146537 >	(021A)	06.86 - 08.89				OIL	200684	100684.0		516004
						GAS	210684	110684.0		516004
	(021A)	09.89 - 12.93				OIL	200685	100685.0		516004
						GAS	210685	110685.0		516004
						GAS	210683	110683.0		516004

IBIZA II













excl. 1.8 16V, 2.0 GTI > Ch. 6K#TR80000	(6K1)	02.93 - 12.95		40A		OIL	200768	100768.0	600040	516004
						GAS	210768	110768.0		
					OIL	201161	101161.0	600700		
					GAS	211161	111161.0			
excl. 1.8 16V, 2.0 GTI Ch. TR80001 > 6K#X#400.000	(6K1)	01.96 - 08.99		40A		OIL	200768	100768.0	600040	516004
						GAS	210768	110768.0		
					OIL	201161	101161.0	600700		
					GAS	211161	111161.0			
1.8 16V, 2.0 GTI > Ch. 6K-ZR082400 > Ch. 6K-ZR599964	(6K1)	10.93 - 03.99		40A		GAS	210768	110768.0	600040	516004
						OIL	201162	101162.0	600700	
					GAS	211162	111162.0			
1.8 16V, 2.0 GTI Ch. 6K-ZR082401 > Ch. 6K-ZR599965 >	(6K1)	10.93 - 03.99		40B		GAS	210769	110769.0	600040	516004
						OIL	201162	101162.0	600700	
					GAS	211162	111162.0			

















SEAT (E)

 excl. 1.8 20V Turbo Ch. 6K#X#400.001>	(6K1)	03.99 - 02.02		40B		GAS	210769	110769.0	600040	516004
						OIL	201163	101163.0	600700	
1.8 20V Turbo	(6K2)	03.99 - 10.02		40B		GAS	210769	110769.0	600040	516004
						GAS	211163	111163.0	600700	







IBIZA III

 excl. 1.8 20V Turbo excl. 	(6L1)	02.02 - 11.09		N.D. 4A		OIL	200688	100688.0	600350	516004
				N.D. 4A		GAS	210688	110688.0		
				H.D. 4B		GAS	210126	110126.0		
1.8 20V Turbo	(6L1)	02.02 - 11.09				GAS	211847	111847.0	600290	516010
				4B		GAS	210126	110126.0	600350	516004
						GAS	211842	111842.0	600290	516010















IBIZA IV

	(6J5, 6P1)	03.08 - 06.17				GAS	210689	110689.0	600270	516004
						GAS	211843	111843.0	600290	516010
	(6J8, 6P8)	03.10 - 07.16				GAS	210689	110689.0	600270	516004
						GAS	211843	111843.0	600290	516010
	(6J1, 6P5)	07.08 -				GAS	210689	110689.0	600270	516004
						GAS	211843	111843.0	600290	516010













INCA

	(6K9)	11.95 - 06.09		40C		OIL	200771	100771.0	600050	516004
						GAS	210771	110771.0		
								GAS	211840	111840.0







LEON I

1.4 16V, 1.6, 1.6 16V, 1.9 SDI excl.  	(1M1)	10.98 - 06.06		4A		OIL	200772	100772.0	600270	516004
						GAS	210772	110772.0		
								GAS	211252	111252.0
1.8, 2.3, 1.9 TDI excl. 1.8 Turbo,  	(1M1)	10.98 - 06.06		4B		OIL	200124	100124.0	600270	516004
						GAS	210124	110124.0		
								GAS	211252	111252.0

LEON II

excl. 	(1P1)	09.05 - 12.12		5A		GAS	210776	110776.0	600430	516004
				5B		GAS	210127	110127.0		
							GAS	211916	111916.0	
	(1P1)	09.05 - 12.12		5A		GAS	210777	110777.0	600430	516004
				5B		GAS	210128	110128.0	600430	
							GAS	211260	111260.0	

LEON III

excl. Cupra, 	(5F1)	09.12 -		5A		GAS	210785	110785.0		516004
				5B		GAS	210784	110784.0		
							GAS	211924	111924.0	

SEAT (E)

LEON IV

SC excl.	(5F5)	01.13 -		5B		GAS	210784	110784.0			516004
				5A		GAS	210785	110785.0			
ST excl.	(5F8)	08.13 -		5B		GAS	210784	110784.0			516004
				5A		GAS	210785	110785.0			
						GAS	211924	111924.0			516010
						GAS	210784	110784.0			516004
						GAS	210785	110785.0			516004
						GAS	211924	111924.0			516010

MALAGA / CREDOS

> Ch. 9071599		11.84 - 08.86				OIL	200682	100682.0	600570	
Ch. 9071600 >	(023A)	09.86 - 08.89				OIL	200684	100684.0		
						GAS	210684	110684.0		
		09.89 - 12.93				GAS	210683	110683.0		
						OIL	200685	100685.0		
						GAS	210685	110685.0		
						GAS	210683	110683.0		

MARBELLA

	(28, 28A)	08.86 - 03.89				GAS	210255	110255.0	600570	516004
						OIL	200255	100255.0		
		04.89 - 10.98				OIL	201390	101390.0		-
						OIL	200687	100687.0		516004
						OIL	201390	101390.0		-

MII

	(KF1, KE1)	10.11 - 07.19				GAS	210783	110783.0	600270	516004
						GAS	211923	111923.0		516010

PANDA

	(141A)	10.80 - 12.86				OIL	200255	100255.0	600570	516004
						GAS	210255	110255.0		
						OIL	201390	101390.0		-

RONDA / RITMO



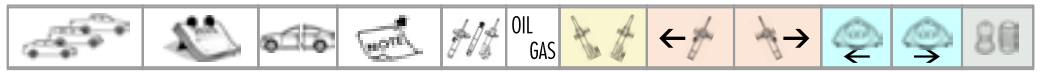

	(022A, 138)	07.78 - 09.83				OIL	200256	100256.0	600570	516004
						GAS	210256	110256.0		
excl. Crono	(022A, 138)	10.83 - 03.86				GAS	210683	110683.0		
						OIL	200682	100682.0	600570	516004
excl. Crono	(022A, 138)	05.86 - 11.88				GAS	210683	110683.0		
						OIL	200684	100684.0		516004
Crono	(022A, 138)	10.83 - 03.86				GAS	210684	110684.0		
						GAS	210683	110683.0		
						OIL	200682	100682.0	600570	516004
						GAS	210683	110683.0		

TERRA























	(024, 024A)	01.87 - 03.89				OIL	200255	100255.0	600570	516004
						GAS	210255	110255.0		
						OIL	201390	101390.0		-

















SEAT (E)

	(024, 024A)	04.89 - 12.96				OIL	200687	100687.0			516004
						OIL	201390	101390.0			-













TOLEDO I

 1.6, 1.9 D, 1.9 TD, 1.9 TDI	(1L)	01.91 - 12.92		40A		OIL	200768	100768.0	600040	516004
						GAS	210768	110768.0		
						OIL	201174	101174.0	600700	
						GAS	211174	111174.0		
 1.6, 1.9 D, 1.9 TD, 1.9 TDI	(1L)	01.93 - 10.99		40A		OIL	200768	100768.0	600040	516004
						GAS	210768	110768.0		
						OIL	201174	101174.0	600700	
						GAS	211174	111174.0		
 1.8, 1.8 16V, 2.0, 2.0 16V	(1L)	01.91 - 12.92		40D		GAS	210767	110767.0	600040	516004
						GAS	211174	111174.0		
 1.8, 1.8 16V, 2.0, 2.0 16V	(1L)	01.93 - 10.99		40D		GAS	210767	110767.0	600040	516004
						GAS	211174	111174.0		





TOLEDO II

 1.4 16V, 1.6, 1.6 16V 1.9 SDI Excl.  , 	(1M2)	04.99 - 05.06		4A		OIL	200772	100772.0	600270	516004
						GAS	210772	110772.0		
						GAS	211251	111251.0	600290	516010
						OIL	200124	100124.0	600270	516004
 1.8, 2.3 V5, 1.9 TDI Excl. 1.8 Turbo,  , 	(1M2)	04.99 - 05.06		4B		GAS	210124	110124.0		
						GAS	211251	111251.0		







TOLEDO III

 excl. 	(5P2)	04.04 - 05.09		5A		GAS	210776	110776.0	600430	516004
						GAS	210127	110127.0		
						GAS	211916	111916.0		516010
						GAS	210777	110777.0	600430	516004
 	(5P2)	04.04 - 05.09		5B		GAS	210128	110128.0		
						GAS	211260	111260.0		

TOLEDO IV







	(KG3)	07.12 - 04.19				GAS	210689	110689.0	600270	516004
						GAS	211843	111843.0	600290	516010

TRANS







		01.85 - 12.96				OIL	200255	100255.0	600570	516004
						GAS	210255	110255.0		
						OIL	201390	101390.0		-

SKODA (CS)



100 SERIES

100, 105, 110, 120	(742, 744)	01.70 - 12.90			+						
					+	OIL	201845	101845.0			
130,  130, Rapid		04.81 - 10.91			+						
					+						
135		11.88 -			+						
					+	OIL	201845	101845.0			























1000 SERIES

 excl. 		09.64 - 01.70			+						
					+	OIL	201845	101845.0			
 Octavia		01.67 - 01.70			+						
					+						





CITIGO

		10.11 -			+	GAS	210783	110783.0	600270	516004
					+	GAS	211923	111923.0		516010









FABIA

 1.0, 1.4, 1.4 16V, 2.0, 1.9 SDI excl. 	(6Y2, 6Y3, 6Y5)	12.99 - 03.08		4A	+	OIL	200694	100694.0	600350	516004
					+	GAS	210694	110694.0		
					+	GAS	211847	111847.0	600290	516010
 1.4 TDI, 1.9 TDI excl. 	(6Y2, 6Y3, 6Y5)	12.99 - 03.08		4A	+	OIL	200688	100688.0	600350	516004
					+	GAS	210688	110688.0	600350	
					+	GAS	211842	111842.0	600290	516010
	(542)	12.06 - 12.14		4A	+	GAS	210688	110688.0	600350	516004
					+	GAS	211847	111847.0	600290	516010
 Combi	(545)	10.07 - 12.14		4A	+	GAS	210688	110688.0	600350	516004
					+	GAS	211842	111842.0	600290	516010
 excl. 	(NJ3)	08.14 -			+	GAS	210689	110689.0	600270	516004
					+	GAS	211843	111843.0	600290	516010
 excl. 	(NJ5)	08.14 -			+	GAS	210689	110689.0	600270	516004
					+	GAS	211843	111843.0	600290	516010



FAVORIT

 excl. 	(781)	05.89 - 09.94			+	OIL	200690	100690.0		516004
					+	OIL	201164	101164.0	600700	516010

FELICIA

 ,  , excl. ABS	(6U1, 6U5, 797)	10.94 - 06.01			+	OIL	200691	100691.0		516004
					+	OIL	201164	101164.0	600700	516010
 ,  , ABS	(6U1, 6U5, 797)	10.94 - 06.01			+	OIL	200691	100691.0		516004
					+	OIL	201164	101164.0	600700	516010

FELICIA PICK-UP

	(6UF, 6U7)	06.97 - 04.02			+	OIL	200691	100691.0		516004
					+	OIL	201164	101164.0	600700	516010

SKODA (CS)

FORMAN

	(785)	08.91 - 10.94				OIL	200690	100690.0			516004
						OIL	201164	101164.0	600700	516010	

KAROQ

	(785)	08.91 - 10.94				OIL	200690	100690.0			516004
						OIL	201164	101164.0	600700	516010	

KAMIQ *NEW*

	(NW4)	07.19 -				GAS	212240	112240.0			
						GAS	212241	112241.0			

KODIAQ *NEW*

excl. †	(NS7, NV7)	10.16 -				GAS	212156	112156.0			516007
						GAS	212217	112217.0			516001

OCTAVIA

1.4, 1.6, 1.9 SDI, 1.9 TDI excl. 4X4	(1U2)	10.96 - 12.10		4A		OIL	200772	100772.0	600270	516004
						GAS	210772	110772.0		
1.8, 2.0, 1.8 Turbo excl. RS 1.8 Turbo, 4X4	(1U2)	10.96 - 12.10		4B		OIL	200124	100124.0	600270	516004
						GAS	210124	110124.0		
4X2 excl. RS 1.8 Turbo	(1U5)	07.98 - 12.10		4A		OIL	200772	100772.0	600270	516004
						GAS	210772	110772.0		
4X4	(1U5)	07.98 - 12.10		4A		OIL	200772	100772.0	600270	516004
						GAS	210772	110772.0		
excl. ‡	(1Z3, 1Z5)	06.04 - 06.13		5A		GAS	210776	110776.0	600430	516004
				5B		GAS	210127	110127.0		
	(1Z3)	06.04 - 06.13		5A		GAS	210777	110777.0	600430	516004
				5B		GAS	210128	110128.0		
Assale rigido excl. RS	(5E3, 5E5)	11.12 -		5A		GAS	210785	110785.0		516004
				5B		GAS	210784	110784.0		
Assale Multilink excl. RS	(5E3, 5E5)	11.12 -		5A		GAS	210785	110785.0		516004
				5B		GAS	210784	110784.0		
						GAS	211924	111924.0		516010
						GAS	211925	111925.0		

RAPID



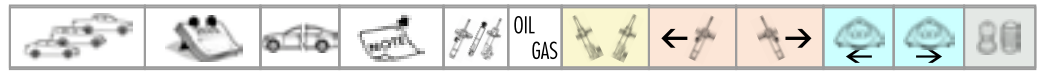

		02.83 - 10.91									516004

RAPID II





	(NH3)	07.12 -				GAS	210689	110689.0	600270	516004
						GAS	211843	111843.0	600290	516010





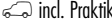













SKODA (CS)

 Spaceback	(NH1)	07.12 -				GAS	210689	110689.0	600270	516004
						GAS	211843	111843.0	600290	516010



ROOMSTER

 incl. Praktik	(5J)	05.06 - 05.15				GAS	210688	110688.0	600350	516004
						GAS	211252	111252.0	600290	516010

SUPERB







 excl. 	(3U4)	02.02 - 03.08				GAS	211008	111008.0	600060	
						GAS	211253	111253.0		516010
	(3T4)	03.08 - 05.15				GAS	210776	110776.0	600430	516004
						GAS	211916	111916.0		516010
	(3T5)	10.09 - 05.15				GAS	210777	110777.0	600430	516004
						GAS	211260	111260.0		516010
 Assale multilink excl.  , 	(3V3, 3V5)	03.15 -		5A		GAS	210785	110785.0		516004
						GAS	211925	111925.0		516010

YETI







	(5L)	05.09 - 12.17		5B		GAS	210127	110127.0	600430	516004
				5A		GAS	210776	110776.0	600430	
						GAS	211848	111848.0		516010

SMART (D)







CABRIO

	(450)	03.00 - 01.04			☒	GAS	212057	112057.0			
						☒	GAS	212058	112058.0		
	(450)	03.00 - 01.04			☒	GAS	211216	111216.0			
						☒	GAS	212058	112058.0		







CITY-COUPÉ

	(MC01)	07.98 - 01.04			☒	GAS	212057	112057.0			
						☒	GAS	212058	112058.0		
	(MC01)	07.98 - 01.04			☒	GAS	211216	111216.0			
						☒	GAS	212058	112058.0		

CROSSBLADE

	(450)	06.02 - 12.03			☒	GAS	212057	112057.0			
						☒	GAS	212058	112058.0		
	(450)	06.02 - 12.03			☒	GAS	211216	111216.0			
						☒	GAS	212058	112058.0		







FORFOUR

	(454)	04.04 - 06.06			☒	GAS	210937	110937.1	110937.2		
						☒	GAS	212059	112059.0		
	(453)	07.14 -			☒	GAS	210671	110671.0			
						☒	GAS	212094	112094.0		

FORTWO

	(450)	01.04 - 12.06			☒	GAS	212057	112057.0			
						☒	GAS	212058	112058.0		
	(450)	01.04 - 12.06			☒	GAS	211216	111216.0			
						☒	GAS	212058	112058.0		
	(451)	01.07 -			☒	GAS	211217	111217.0			
						☒	GAS	212060	112060.0		
	(453)	07.14 -			☒	GAS	210671	110671.0			
						☒	GAS	212094	112094.0		



ROADSTER

	(452)	04.03 - 11.05			☒	GAS	212057	112057.0			
						☒	GAS	212058	112058.0		
	(452)	04.03 - 11.05			☒	GAS	211216	111216.0			
						☒	GAS	212058	112058.0		





SSANGYONG (KO)







KORANDO

	(KJ)	12.96 - 11.06			⊖	GAS	212045	112045.0			
						⊖	GAS	212046	112046.0		

MUSSO

	(FJ)	10.95 - 09.07			⊖	GAS	212043	112043.0			
						⊖	GAS	212044	112044.0		

REXTON

	(GAB)	04.02 - 08.06			≠	GAS	211214	111214.0			
						⊖	GAS	212047	112047.0		
	(GAB)	01.07 -			≠	GAS	211215	111215.0			
						⊖	GAS	212048	112048.0		

SUBARU (J)

FORESTER

2.0 4WD excl. Turbo,	(SF5)	08.97 - 09.02				GAS	210704	110704.1	110704.2			
					GAS	210705	110705.1	110705.2				
2.0, 2.0 Turbo 4WD, excl.	(SG5)	09.02 - 01.03				GAS	210711	110711.1	110711.2			
					GAS	210712	110712.1	110712.2				
2.0, 2.0 Turbo 4WD, excl. 2.5 excl.	(SG5) (SG5)	01.03 - 09.04				GAS	210713	110713.1	110713.2			
					GAS	210712	110712.1	110712.2				

IMPREZA

1.6, 1.8, 2.0 2WD	(GC, GF 3/5/7)	08.92 - 12.00				GAS	210706	110706.1	110706.2			
					GAS	210707	110707.1	110707.2				
1.6, 1.8, 2.0 4WD excl. 2.0 GT Turbo	(GC, GF 4/6/8)	08.92 - 12.00				GAS	210706	110706.1	110706.2			
					GAS	210709	110709.1	110709.2				
2.0 GT Turbo 4WD	(GC, GF 8_L8)	08.92 - 12.00				GAS	210708	110708.1	110708.2			
					GAS	210709	110709.1	110709.2				
2.0, 2.0 Turbo WRX excl. WRX-Sti	(GD)	10.00 - 10.02				GAS	210715	110715.1	110715.2			
					GAS	210716	110716.1	110716.2				
2.0, 2.0 Turbo WRX excl. WRX-Sti	(GD)	11.02 - 12.02				GAS	210715	110715.1	110715.2			
					GAS	210720	110720.1	110720.2				
2.0, 2.0 Turbo WRX excl. WRX-Sti	(GD)	01.03 - 06.09				GAS	210722	110722.1	110722.2			
					GAS	210716	110716.1	110716.2				
1.6, 2.0, 2.0 Turbo WRX	(GG)	10.00 - 10.02				GAS	210717	110717.1	110717.2			
					GAS	210718	110718.1	110718.2				
1.6, 2.0, 2.0 Turbo WRX excl. WRX-Sti	(GG)	11.02 - 12.02				GAS	210717	110717.1	110717.2			
					GAS	210719	110719.1	110719.2				
1.6, 2.0, 2.0 Turbo WRX excl. WRX-Sti	(GG)	01.03 - 12.08				GAS	210721	110721.1	110721.2			
					GAS	210719	110719.1	110719.2				

































JUSTY

1.3	(HSJ56, HSN56)	10.95 - 08.03				GAS	210710	110710.0				
					GAS	210703	110703.0					
	(G3X)	09.03 -				GAS	210714	110714.1	110714.2			
					GAS	211696	111696.0					





















LEGACY

4X2	(BC, BF, BJ)	01.89 - 12.91				GAS	210697	110697.1	110697.2			
					GAS	210701	110701.1	110701.2				
4X2	(BC, BF, BJ)	01.92 - 08.94				GAS	210698	110698.1	110698.2			
					GAS	210702	110702.1	110702.2				
4X4	(BC, BF, BJ)	01.89 - 12.91				GAS	210697	110697.1	110697.2			
					GAS	210699	110699.1	110699.2				
4X4 excl. 2.0 Turbo	(BC, BF, BJ)	01.92 - 08.94				GAS	210698	110698.1	110698.2			
					GAS	210700	110700.1	110700.2				
2.0 Turbo 4X4	(BC, BF 5_L8)	01.92 - 08.94				GAS	210723	110723.1	110723.2			
					GAS	210700	110700.1	110700.2				

SUBARU (J)





4X2	(BD, BG)	01.94 - 03.99			GAS	210706	110706.1	110706.2			
					GAS	210724	110724.1	110724.2			
2.0, 2.2 4X4	(BD, BG 5/7)	01.94 - 03.99			GAS	210706	110706.1	110706.2			
					GAS	210725	110725.1	110725.2			
2.5 4X4 excl. Outback	(BD, BG 9_L9)	06.96 - 03.99			GAS	210723	110723.1	110723.2			
					GAS	210726	110726.1	110726.2			
2.5 Outback 4X4	(BG9_LB)	06.96 - 12.99			GAS	210727	110727.1	110727.2			
					GAS	210728	110728.1	110728.2			
2.0, 2.5 4X4 excl. ⚡, Ⓜ, Outback	(BE, BH)	12.98 - 09.03			GAS	210729	110729.1	110729.2			
					GAS	211167	111167.0				
2.5 Outback 4X4 excl. ⚡, Ⓜ	(BE, BH)	12.98 - 09.03			GAS	210730	110730.1	110730.2			
					GAS	211168	111168.0				
2.0i, 2.5i, 3.0R 4X4 excl. 3.0R Spec B, Outback	(BL)	09.03 - 11.15			GAS	210731	110731.1	110731.2			
					GAS	211169	111169.0				
2.0i, 2.5i, 3.0R Outback 4X4 excl. Ⓜ	(BP)	09.03 - 12.09			GAS	210732	110732.1	110732.2			
					GAS	211170	111170.0				

LEONE II / LOYALE / L



















4X2	(AC)	09.84 - 09.91			GAS	210695	110695.1	110695.2			
					GAS	211165	111165.0				
4X2	(AG)	09.84 - 12.89			GAS	210695	110695.1	110695.2			
					GAS	211165	111165.0				
4X2	(AN)	09.84 - 12.93			GAS	210695	110695.1	110695.2			
					GAS	211166	111166.0				
Ⓜ, Ⓜ, Ⓜ excl. □ Ⓜ excl. 1.8 Turbo, □ 4X4	(AC, AG, AN)	09.84 - 12.86 01.87 - 12.93			GAS	210696	110696.1	110696.2			
											
1.8 Turbo excl. □ Ⓜ, Ⓜ excl. □ 4X4	(AC, AG, AN)	01.87 - 12.89 01.87 - 12.93			GAS	210696	110696.1	110696.2			
					GAS	211166	111166.0				

SUZUKI (J)





ALTO I / FRONTE

	(SS80)	06.82 - 08.84	 	 	OIL	201314	101314.0					
---	--------	---------------	--	--	-----	--------	----------	--	--	--	--	--





ALTO II / FRONTE

 (SB308) 	(CA91, CB91)	12.85 - 12.87	 	 	OIL	200739	100739.0					516004
 (SB308) 	(CA91, CB91)	01.88 - 12.90	 	 	OIL	200739	100739.0					516004
 (SB308) 	(EC)	01.91 - 02.94	 	 	OIL	200739	100739.0					516004





ALTO III / FRONTE

 (SH410)	(FA11, FB11)	10.94 - 06.02	 	 	GAS	210741	110741.1	110741.2				516004
					GAS	211860	111860.0					-









ALTO IV / FRONTE

 (RF410)	(FF)	06.02 - 12.08	 	 	GAS	212119	112119.1	112119.2				
					GAS	211859	111859.0					-



















ALTO V

 1.0	(GF)	01.09 -	 	 	GAS	212120	112120.1	112120.2				516004
					GAS	211966	111966.0					-









































BALENO

   1.3 (SY41_) excl. 	(EG)	07.95 - 05.02	 	 	GAS	210742	110742.1	110742.2				516004
					GAS	210743	110743.1	110743.2				516004

CARRY

	(ST90V)	11.80 - 10.85	 	 	OIL	201314	101314.0					516004
 excl.  	(SK 408/410)	01.86 - 03.99	 	 	OIL	201314	101314.0					516004
 	(SK 408/410)	01.86 - 03.99	 	 	OIL	201315	101315.0					-

GRAND VITARA

 1.6 3(m)	(SQ416 - TA0)	03.98 - 09.05	 	 	GAS	210744	110744.1	110744.2				516004
 2.0 3(m)	(SQ420 - TA/L5)	03.98 - 09.05	 	 	GAS	210744	110744.1	110744.2				516004
 2.0 5(m)			 	 	GAS	211863	111863.0					-
 2.0 TD 5(m)	(SQ420 - TD3)	03.98 - 09.05	 	 	GAS	210744	110744.1	110744.2				516004
 2.5 5(m)	(SQ420 - TD6)		 	 	GAS	211863	111863.0					-
 1.6 3(m)	(JT, TE, TD)	01.06 -	 	 	GAS	210745	110745.1	110745.2				516004
 1.9 DDIS 3(m)			 	 	GAS	211864	111864.0					-
 2.0 L 5(m)	(JT, TE, TD)	01.06 -	 	 	GAS	210745	110745.1	110745.2				516004
1.9 DDIS 5(m)			 	 	GAS	211864	111864.0					-

SUZUKI (J)

IGNIS

🚗 1.3 2WD	(FH)	10.00 - 09.03			GAS	210746	110746.1	110746.2			516004
					GAS	211865	111865.0			-	
🚗 1.3 4WD	(FH)	10.00 - 09.03			GAS	210746	110746.1	110746.2			516004
					GAS	211866	111866.0			-	
🚗 1.3 2WD excl. 1.3 DDIS 🚗 1.5 2WD/4WD	(MH)	09.03 -			GAS	210714	110714.1	110714.2			516004
					GAS	211696	111696.0			-	
🚗 1.3 DDIS	(MH)	09.03 -			GAS	210747	110747.1	110747.2			516004
					GAS	211696	111696.0			-	

JIMNY

LJ 10, LJ 20 SJ 10, LJ 81		01.70 - 06.77 01.70 - 06.77			OIL	201850	101850.0			516004
					GAS	211835	111835.0			-
LJ 80, LJ 80 Q, LJ 80 V LJ 81 K, LJ 81 P		06.77 - 12.81 06.77 - 12.81			OIL	201850	101850.0			516004
					GAS	211835	111835.0			-
SJ 410, SJ 413		01.81 - 12.87			OIL	201850	101850.0			516004
					GAS	211835	111835.0			-
SJ 413-4 Samurai ~		01.87 - 12.04			OIL	201850	101850.0			516004
					GAS	211835	111835.0			-
SJ 419 Samurai		09.98 -								
🚗 (SN 413) III	(SN)	09.98 -			GAS	211857	111857.0			516004
					GAS	211858	111858.0			-

MARUTI

🚗		02.88 - 12.94			OIL	200738	100738.1	100738.2			
					OIL	201854	101854.0			-	

SPLASH

🚗	(EX)	01.08 -			GAS	210748	110748.1	110748.2			516004
					GAS	211867	111867.0			516010	

































SWIFT I

🚗 1.0, 1.3 (SA 310, 413)	(AA41, AA51)	10.83 - 12.85									516004
										-	
🚗 1.0, 1.3, 1.3 GTi/GXi (SA 310-3, 413-3)	(AA43, AA53, AA33)	01.86 - 12.89									516004
										516010	





SWIFT II

🚗 1.0 (SF310), excl. GTi, 4WD 🚗 1.3 (SF413), excl. GTi, 4WD	(AA/AB 44) (AA/AB 35)	03.89 - 1992 03.89 - 1992			GAS	210734	110734.0				516004
					GAS	210735	110735.0			516004	
🚗 1.3 GTi (SF413) > Ch. S00104275	(AA 34)	03.89 - 12.89			GAS	210734	110734.0				516004
					GAS	210735	110735.0			516004	
🚗 1.3 4WD (SF413) > Ch. S00102077	(AF 35)	03.89 - 12.90			GAS	210736	110736.0				516004
					GAS	210735	110735.0			516004	





SUZUKI (J)

🚗 1.3 GTi (SF413) Ch. S00104276 > S0014000	(AA 34)	01.90 - 1992			GAS	210736	110736.0			516004
					GAS	210735	110735.0			516004
🚗 1.0 (SF310) 🚗 1.3 (SF413)	(AA/AB 44) (AA/AB 35)	1992 - 11.96			GAS	210736	110736.0			516004
					GAS	210735	110735.0			516004
🚗 1.3 GTi (SF413) Ch. S00140001 > 🚗 1.3 4WD (SF413) > Ch. S00102077	(AA 34) (AF 35)	1992 - 11.96 01.91 - 11.96			GAS	210736	110736.0			516004
					GAS	210735	110735.0			516004
🚗 1.3 (SF413) > Ch. 00107571	(AH 35)	03.89 - 1990			GAS	210736	110736.0			516004
					GAS	210735	110735.0			516004
🚗 1.6 2WD (SF416) > Ch. 00109591 🚗 1.6 4WD (SF416) > Ch. 00102383	(AH 14) (AJ 14)	03.89 - 1990			GAS	210736	110736.0			516004
					GAS	210735	110735.0			516004
🚗 1.3 (SF413) Ch. 00107572 >	(AH 35)	1990 - 11.96			GAS	210736	110736.0			516004
					GAS	210735	110735.0			516004
🚗 1.6 2WD (SF416) Ch. 00109592 > 🚗 1.6 4WD (SF416) Ch. 00102384 >	(AH 14) (AJ 14)	1990 - 11.96			GAS	210736	110736.0			516004
					GAS	210735	110735.0			516004
🚗 1.3 (SF413)	(AK 35)	09.91 - 11.96			GAS	210736	110736.0			516004
					GAS	210735	110735.0			516004









SWIFT III

🚗 1.3	(RS413)	05.05 -			GAS	210748	110748.1	110748.2			516004
🚗 1.5	(RS415)	05.05 -			GAS	211867	111867.0				





SWIFT IV

🚗 1.2, 1.3 DDiS excl. 4WD	(FZ, NZ)	10.10 -			GAS	210750	110750.1	110750.2			516004
					GAS	211867	111867.0				









SX4

🚗 1.5L, 1.9 2WD excl. + 🚗 1.6L VVT 2WD excl. +	(EY, GY)	06.06			GAS	210158	110158.1	110158.2			516004
					GAS	211295	111295.0				
🚗 1.6L VVT 4WD 🚗 1.9L 4WD	(EY, GY)	06.06			GAS	210165	110165.1	110165.2			516004
					GAS	211299	111299.0				





SX4 S-CROSS *NEW*

🚗	(JY)	08.13 -			GAS	212198	112198.1	112198.2			516004
					GAS	212199	112199.0				516010









VITARA / ESCUDO / SANTANA / SIDEKICK

🚗 2 (m) e+e	(ET, TA)	07.88 - 03.98			GAS	210737	110737.1	110737.2			516004
					GAS	211863	111863.0				
🚗 4 (m) e+e	(ET, TA)	01.91 - 03.98			GAS	210737	110737.1	110737.2			516004
					GAS	211863	111863.0				

VITARA *NEW*

🚗	(LY)	02.15 -			GAS	212198	112198.1	112198.2			516004
					GAS	212199	112199.0				516010





WAGON R+

1.0 (SR410) 1.2 (SR412) incl. 4X4	(MA61) (MA81, MB81)	05.98 - 05.00 05.98 - 05.00			GAS	210740	110740.1	110740.2			516004
					GAS	211859	111859.0				-
1.3 (RB413) excl. 4X4	(MA53)	06.00 -			GAS	210574	110574.1	110574.2	600620		516004
					GAS	211696	111696.0				-







SUZUKI (J)

X-90



 (SZ416)	(LA1, LB1)	09.95 - 12.97				GAS	210749	110749.1	110749.2			516004
						GAS	211863	111863.0				

TALBOT (F) (GB)



1100 / 1200 SIMCA

		10.68 - 01.80			⊘	OIL	201239	101239.0			
VF 1		1976 - 01.80			⊘						
VF 2		1967 -			⊘	OIL	201239	101239.0			
											



1307 / 1308 / 1309

		07.75 - 08.81			⊘	OIL	201868	101868.0			
					⊘						



1510

1510, incl. Alpine		10.78 - 04.84			⊘	OIL	201870	101870.0			
											



ALPINE

		1976 - 1980			⊘	OIL	201868	101868.0			
					⊘						



EXPRESS

Express (> Fiat Ducato)		1983 -			⊘						
					⊘	OIL	201347	101347.0			-





HORIZON

1.1, 1.3, 1.5, 1.6, 1.9D		02.78 - 06.86			⊘	OIL	201870	101870.0			
					⊘						



MATRA BAGHEERA

	(X)	01.74 - 09.80			⊘	OIL	201239	101239.0			
											



SAMBA

 excl. Rallye	(51A, 51E)	01.81 - 10.86			⊘	OIL	200202	100202.0			
					⊘	OIL	201039	101039.0			
Rallye		01.83 - 10.86			⊘						
					⊘	OIL	201039	101039.0			



SOLARA / MINX / RAPIER

LS, GL, GLS, SX, Alpine		02.80 - 07.86			⊘	OIL	201870	101870.0			
					⊘						

SUMBEAM

 excl. Lotus, Ti		07.77 - 03.82			/	OIL	200060	100060.0			
					⊘						

TAGORA

		06.80 - 12.87			/						
					⊘	OIL	201715	101715.0			

TOYOTA (J)

4 RUNNER

RN 61	(N5, N6, N7)	08.87 - 07.89				GAS	211884	111884.0			
					GAS	211248	111248.0				
LN 130, VZN 130 4X4	(N1)	01.90 - 03.96				GAS	211884	111884.0			
					GAS	211885	111885.0				
RZN 180, RZN 185, VZN 185	(N18)	11.95 - 11.02									

AURIS

	(_E15_)	10.06 - 09.12			GAS	210866	110866.1	110866.2			516004
					GAS	211996	111996.0				516010
	(_E18_)	10.12 - 12.18			GAS	210866	110866.1	110866.2			516004
					GAS	211996	111996.0				516010
	(_E18_)	07.13 - 12.18			GAS	210866	110866.1	110866.2			516004
					GAS	212114	112114.0				516010

AVENSIS

	(A/S/CT220/1)	09.97 - 07.00			GAS	210764	110764.1	110764.2			516004
					GAS	210765	110765.1	110765.2			516004
	(_ZT220/1) (CDT220)	07.00 - 12.02			GAS	210764	110764.1	110764.2			516004
					GAS	210765	110765.1	110765.2			516004
	(_T250/251)	04.03 - 11.08			GAS	210845	110845.1	110845.2			516004
					GAS	211199	111199.0				516010

AVENSIS VERSO

2.0, 2.0 D	(ACM20, CLM20)	08.01 - 11.09			GAS	210846	110846.1	110846.2			516004
					GAS	211977	111977.0				516010

AYGO

	1.0i, 1.4D	(B1)	07.05 - 05.14			GAS	210223	110223.1	110223.2			516004
						GAS	211356	111356.0				516010

AYGO II

	(B4)	05.14 -			GAS	210223	110223.1	110223.2			516004
					GAS	211356	111356.0				516010













































C-HR *NEW*

	(X1)	10.16 -			GAS	212162	112162.1	112162.2			516006
					GAS	212163	112163.0				516010







































































CAMRY

	1.8 (SV10)	10.82 - 09.86									516004
					GAS	210755	110755.0				516004
	2.0 (SV11, CV11)	06.83 - 09.86									516004
					GAS	210755	110755.0				516004
	1.8 D Turbo (CV10)	05.85 - 09.86									516004
					GAS	210755	110755.0				516004
	1.8, 2.0 excl. 4X4 (SV20/21)	10.86 - 08.91 01.89 - 08.91 10.86 - 08.91									516004
											516004



















TOYOTA (J)

 2.5 V6 excl. 4X4  2.0 D Turbo excl. 4X4	(ZV21) (CV20)	10.86 - 08.91		/	GAS	210063	110063.0					516004
		01.89 - 08.91 10.86 - 08.91		/								
 2.0 4X4	(SV25)	08.88 - 08.91		/								516004
												
 2.2  3.0 V6	(SVX10) (VVC10)	10.91 - 08.96 10.91 - 08.96			GAS	210848	110848.1	110848.2				516004
					GAS	210760	110760.1	110760.2				
 2.2  3.0 V6	(SXV20) (MCV20)	09.96 - 09.02 09.96 - 09.02			GAS	210842	110842.1	110842.2				516004
					GAS	210843	110843.1	110843.2				
 2.0, 2.4, 3.0	(ACV30/31, MCV30)	08.01 - 11.06			GAS	210849	110849.1	110849.2				516004
					GAS	210850	110850.1	110850.2				
 Wagon 1.8, 2.0  Wagon 2.0 D Turbo	(SV20/21) (CV20)	10.86 - 02.92 10.86 - 02.92		/	GAS	210063	110063.0					516004
				/								
 Wagon 2.2  Wagon 3.0 V6	(SVX10) (VVC10)	03.92 - 12.94 03.92 - 12.94			GAS	210759	110759.1	110759.2				516004
					GAS	210760	110760.1	110760.2				
 Wagon 2.2  Wagon 3.0 V6	(SVX10) (VVC10)	01.95 - 08.96 01.95 - 08.96			GAS	210848	110848.1	110848.2				516004
					GAS	210760	110760.1	110760.2				
2.4i 16V LE, 2.4i Auto 16V LE, 2.4 VVTi	(V4)	01.06 - 12.14			GAS	212097	112097.1	112097.2				
					GAS	212098	112098.1	112098.2				

CARINA II / CORONA

 ,  ,  1.6	(AT151)	10.83 - 12.87		/	GAS	210068	110068.0					516004
												
 ,  ,  1.8, 2.0 D  ,  ,  2.0	(ST150, CT150) (ST151)	10.83 - 12.87 08.85 - 12.87		/	GAS	210070	110070.0					516004
												
 ,  ,  1.5  ,  ,  1.6	(AT171) (AT171)	12.87 - 12.89		/	GAS	210068	110068.0					516004
					GAS	210752	110752.0					
 ,  ,  1.5  ,  ,  1.6	(AT171) (AT171)	12.89 - 03.92		/	GAS	210068	110068.0					516004
					GAS	210752	110752.0					
 ,  ,  1.8, 2.0  ,  ,  1.8 D, 2.0 D	(ST171) (CT170)	12.87 - 12.89		/	GAS	210063	110063.0					516004
					GAS	210752	110752.0					
 ,  ,  1.8, 2.0  ,  ,  1.8 D, 2.0 D	(ST171) (CT170)	12.89 - 03.92 12.89 - 06.93		/	GAS	210063	110063.0					516004
					GAS	210752	110752.0					
 Wagon 1.5  Wagon 1.6	(AT171) (AT171)	12.87 - 12.89 12.87 - 12.89		/	GAS	210068	110068.0					516004
					GAS	210752	110752.0					
 Wagon 1.5  Wagon 1.6	(AT171) (AT171)	01.90 - 10.92 01.90 - 10.92		/	GAS	210068	110068.0					516004
					GAS	210752	110752.0					
 Wagon 1.8, 2.0  Wagon 1.8 D, 2.0 D	(ST171) (CT170)	12.87 - 12.89 12.87 - 12.89		/	GAS	210063	110063.0					516004
					GAS	210752	110752.0					
 Wagon 1.8, 2.0  Wagon 1.8 D, 2.0 D	(ST171) (CT170)	01.90 - 10.92 01.90 - 10.92		/	GAS	210063	110063.0					516004
					GAS	210752	110752.0					

CARINA E / CORONA

 ,  1.6	(AT190)	02.92 - 01.96			GAS	210837	110837.1	110837.2				516004
					GAS	210838	110838.1	110838.2				
 ,  2.0 excl. Gti	(ST191)	02.92 - 01.96			GAS	210837	110837.1	110837.2				516004
					GAS	210838	110838.1	110838.2				
 ,  2.0 Gti	(ST191)	02.92 - 01.96										516004
					GAS	210838	110838.1	110838.2				



TOYOTA (J)

2.0 D, 2.0 TD	(CT190)	02.92 - 01.96			GAS	210837	110837.1	110837.2			516004
					GAS	210838	110838.1	110838.2			516004
Wagon 1.6	(AT190)	11.92 - 05.93			GAS	210837	110837.1	110837.2			516004
					GAS	210765	110765.1	110765.2			516004
Wagon 1.6	(AT190)	06.93 - 02.94			GAS	210837	110837.1	110837.2			516004
					GAS	210765	110765.1	110765.2			516004
Wagon 1.6	(AT190)	03.94 - 01.96			GAS	210837	110837.1	110837.2			516004
					GAS	210838	110838.1	110838.2			516004
Wagon 2.0 Wagon 2.0 D	(ST191)	11.92 - 05.93			GAS	210837	110837.1	110837.2			516004
	(CT190)	11.92 - 05.93			GAS	210765	110765.1	110765.2			516004
Wagon 2.0 Wagon 2.0 D	(ST191)	06.93 - 09.97			GAS	210837	110837.1	110837.2			516004
	(CT190)	06.93 - 02.94			GAS	210765	110765.1	110765.2			516004
Wagon 2.0 D	(CT190)	03.94 - 01.96			GAS	210837	110837.1	110837.2			516004
					GAS	210838	110838.1	110838.2			516004

CELICA

1.6, 1.8, 2.0	(AT160, ST160, ST162)	08.85 - 08.87			GAS	210070	110070.0			516004	
					GAS	210753	110753.0			516004	
1.6, 1.8, 2.0 excl. Turbo, 4X4	(AT160, ST162)	08.87 - 08.89			GAS	210063	110063.0			516004	
					GAS	210752	110752.0			516004	
1.6, 2.0 excl. ABS	(AT180, ST182)	09.89 - 10.93			GAS	210072	110072.0			516004	
					GAS	210754	110754.0			516004	
2.0 Turbo 4X4	(ST185)	09.89 - 10.93			GAS	210072	110072.0			516004	
					GAS	210761	110761.1	110761.2			516004
1.8 2.0 excl. GT 4X4	(AT200)	11.93 - 11.99			GAS	210074	110074.0			516004	
	(ST202)	11.93 - 11.99			GAS	210841	110841.1	110841.2			516004
2.0 GT 4X4	(ST205)	11.93 - 11.99			GAS	210851	110851.1	110851.2			516004
					GAS	210852	110852.1	110852.2			516004
1.8	(ZZT230)	08.99 - 11.99			GAS	210853	110853.1	110853.2			516004
					GAS	211978	111978.0				
1.8	(ZZT230)	10.99 - 08.00			GAS	210853	110853.1	110853.2			516004
					GAS	211200	111200.0				
	(ZZT23#)	08.00 - 09.05			GAS	210853	110853.1	110853.2			516004
					GAS	211200	111200.0				

COASTER

RU 19, BU 19		02.72 - 07.77			GAS	211367	111367.0			-
					OIL	201377	101377.0			-
RB 10, 11, 12, 13, BB 10		08.77 - 04.82			OIL	201377	101377.0			-
					OIL	201377	101377.0			-

COROLLA

1.3, 1.5 1.6 excl. GT	(AE80, EE80) (AE82)	05.83 - 05.87			GAS	210068	110068.0			
					GAS	210755	110755.0			516004
1.8 D	(CE80)	05.83 - 05.87			GAS	210070	110070.0			
					GAS	210755	110755.0			
1.6 GT	(AE82)	10.84 - 05.87			GAS	210070	110070.0			
1.3 1.6 excl. GTI	(EE90)	06.87 - 12.92			GAS	210068	110068.0			
					GAS	210844	110844.1	110844.2		

TOYOTA (J)

1.6 GTi	(AE92)	06.87 - 12.92		/	GAS	210063	110063.0				516004
1.8 D	(CE90, CE92)	06.87 - 06.93		/	GAS	210063	110063.0				516004
1.3, 1.6 2.0 D	(A/EE100/1) (CE100)	05.92 - 04.97		/	GAS	210756	110756.1	110756.2			516004
1.3, 1.4, 1.6 1.8, 2.0 D	(A/EE110/1) (AE115, CE11_)	04.97 - 01.02		/	GAS	210756	110756.1	110756.2			516004
1.4, 1.6, 1.9 D	(ZZE11_)	10.99 - 09.01		/	GAS	210756	110756.1	110756.2			516004
1.4, 1.6 excl. Auto. 2.0 TD	(ZZE120/1) (CDE120)	11.01 - 02.07		/	GAS	210854	110854.1	110854.2			516004
1.6 Auto.	(ZZE121)	01.02 - 12.06		/	GAS	210854	110854.1	110854.2			516004
Station Wagon 1.3, 1.6	(EE90, AE92)	06.87 - 06.92		/	GAS	210068	110068.0				516004
Station Wagon 1.6 4X4	(AE95)	10.87 - 12.92		/	GAS	211626	111626.0				516010
Station Wagon 1.8 D	(CE90, CE92)	06.87 - 06.92		/	GAS	210063	110063.0				516004
Wagon 1.3, 2.0 D Wagon 1.6	(C/EE100/1) (AE101)	05.92 - 04.97		/	GAS	210756	110756.1	110756.2			516004
Wagon 1.3, 1.4, 1.6 Wagon 1.8, 2.0 D	(A/EE110/1) (AE115, CE11_)	04.97 - 09.01		/	GAS	210756	110756.1	110756.2			516004
1.4, 1.6 2.0 TD	(ZZE120/1) (CDE120)	10.01 - 05.04		/	GAS	210854	110854.1	110854.2			516004
excl.	(_E18_)	06.13 -		/	GAS	210866	110866.1	110866.2			516004
	(E210)	10.18 -		/	GAS	212242	112242.1	112242.2			



















COROLLA VERSO

1.6, 1.8 2.0 TD	(ZZE121/2) (CDE120)	09.01 - 12.03		/	GAS	210854	110854.1	110854.2			516004
1.6, 1.8 2.0 TD	(ZNR10/1) (CUR10)	02.04 - 03.09		/	GAS	210855	110855.1	110855.2			516004









CROWN

1.9 2.0, 2.3	(RS41) (MS41/5)	01.65 - 08.67		/	GAS	211601	111601.0				
2.0	(MS46)	01.65 - 07.67		/	GAS	211601	111601.0				
2.0 2.3	(RS50, RS60) (MS51, MS55)	09.67 - 09.74 09.67 - 01.71		/	GAS	211601	111601.0				
2.0, 2.3 2.6	(RS80, MS64) (MS65/75) (MS85/95)	10.74 - 08.79 02.71 - 08.79		/	GAS	211601	111601.0				
2.0, 2.2 D 2.6, 2.8	(RS110, LS110) (MS111, MS112)	09.79 - 07.83		/	GAS	211601	111601.0				





TOYOTA (J)

 2.0, 2.5 D  2.8	(Y/LS120) (MS122)	08.83 - 09.87		±	GAS	211601	111601.0			
		08.83 - 09.87 08.83 - 09.87				GAS	211684	111684.0		
 2.8	(MS123, MS125)	08.83 - 09.87		±						
										
 2.0  2.3	(MS56, RS56) (MS57, RS57)	08.67 - 01.71		±	GAS	211601	111601.0			
					∞					
 2.3  2.6	(MS67) (MS63/68) (MS83/88)	02.71 - 01.73		±	GAS	211601	111601.0			
		02.71 - 08.79			∞					
 2.2 D, 2.6  2.8	(L/MS111) (MS112, MS122)	09.79 - 07.80		±	GAS	211601	111601.0			
		09.79 - 09.87 09.79 - 07.81			∞	GAS	211684	111684.0		















DYNA

RU/JU/BU 10, 12, 15 RU/JU/BU 10, 12, 15 H		01.69 - 07.77			GAS	211367	111367.0			-
					∞	OIL	201377	101377.0		
HU 15 H		01.72 - 07.77			OIL	201377	101377.0			-
					∞	OIL	201377	101377.0		
BU 20, 30, 35, 36 JU 20 RU/HU 20, 30		07.77 - 11.84		∞	GAS	211626	111626.0			
		07.77 - 11.84 07.77 - 11.84 07.77 - 11.84			∞	OIL	201377	101377.0		
BU 75 BU 85		08.87 - 05.95		∞						
					∞					















DYNA 100

LH 80 YH 81		08.85 - 05.95		∞	OIL	201645	101645.0			
		08.85 - 05.95			∞					
LY 100		05.95 - 07.01		∞	OIL	201645	101645.0			
					∞					





























HI-ACE

PH 10, LH 10, RH 10 series		10.67 - 01.77		±						
					∞	OIL	201377	101377.0		
RH 20, RH 30, RH 40 series excl. RH22, RH24 LH 20, LH 30, LH 40 series		02.77 - 11.82		±						
					∞	OIL	201377	101377.0		
 RH 22		02.77 - 11.82		±						
					∞					
LH 50, LH 60, LH 70 series YH 50, YH 60, YH 70 series, YH (Serie 50,60,70)		11.82 - 12.83		∞	GAS	211635	111635.0			
		11.82 - 12.83			∞	GAS	211367	111367.0		
LH 50, LH 60, LH 70 series 4X2 YH 50, YH 60, YH 70 series 4X2		01.84 - 08.89		∞	GAS	211635	111635.0			
		01.84 - 08.89			∞					
LH 56, LH 66, YH 56, YH 66 series 4X4		08.86 - 08.89		∞	GAS	211875	111875.0			
					∞					
LH 102, LH 112 4X2 RZH 102/103/112/113/115		08.89 - 08.95		∞	GAS	211489	111489.0			
		08.89 - 08.95			∞	GAS	211876	111876.0		



TOYOTA (J)

LH 108, LH 118, RZH 109, RZH 119 4X4	08.89 - 08.95			♂	GAS	211875	111875.0			
					♀	GAS	211877	111877.0		
LXH 12, LXH 22 4X2 RCH 12, RCH 13, RCH 22, RCH 23 4X2	08.95 - 10.99			♂	GAS	211489	111489.0			
					♀	GAS	211983	111983.0		
LXH 18, LXH 28 4X4 RCH 18, RCH 19, RCH 28, RCH 29 4X4	08.95 - 07.99			♂	GAS	211875	111875.0			
					♀	GAS	211984	111984.0		
RCH 12, RCH 13, RCH 22, RCH 23 4X2	07.99 -			♂	GAS	211489	111489.0			
					♀	GAS	211984	111984.0		
KLH 12, KLH 22 4X2 LXH 12, LXH 22 4X2	07.99 -			♂	GAS	211489	111489.0			
					♀	GAS	211984	111984.0		
KLH 18, KLH 28 4X4 LXH 19, LXH 29 4X4	07.99 -			♂	GAS	211875	111875.0			
					♀	GAS	211984	111984.0		
RCH 19, RCH 22 4X4	07.99 -			♂	GAS	211875	111875.0			
					♀	GAS	211984	111984.0		

HI-LUX











































RN 10/13/15/16/20 4X2 RN 22/25/27/28 4X2	01.68 - 01.79			♂						
					♀	OIL	201377	101377.0		
RN 30/31/32/33/34/35 4X2 RN 40/41/42/44 4X2	01.78 - 03.84			♂						
					♀	OIL	201377	101377.0		
LN 30/40 4X2	01.78 - 03.84			♂						
					♀	OIL	201377	101377.0		
RN 36/39/46 4X4 LN 36/46 4X4	01.79 - 07.83			♂	GAS	211878	111878.0			
					♀	GAS	211596	111596.0		
LN 50/51/55/56 4X2	08.83 - 08.88		N.D.	♂	GAS	211879	111879.0			
					♀	OIL	201377	101377.0		
YN 50/51/52/55/56 4X2 YN 57/58/, RN 50/55 4X2	08.83 - 08.88		N.D.	♂	GAS	211879	111879.0			
					♀	OIL	201377	101377.0		
LN 60/61/65 4X4 ~ YN 60/61/62/65/67 4X4 ~	08.83 - 08.88			♂	GAS	211878	111878.0			
					♀	GAS	211881	111881.0		
LN 85/90 4X2 YN 85/90 4X2	08.88 - 08.97			♂	GAS	211879	111879.0			
					♀	GAS	211625	111625.0		
LN 105 4X4 YN 106 4X4	08.88 - 08.97			♂	GAS	211882	111882.0			
					♀	GAS	211883	111883.0		
LN 108, LN110 4X4 RN 106, RN110, YN 110 4X4	08.88 - 08.97			♂	GAS	211884	111884.0			
					♀	GAS	211883	111883.0		
LN 145, LN150 4X2	08.97 - 08.01			♂	GAS	211879	111879.0			
					♀	GAS	211997	111997.0		
LN 165, LN170 4X4 RZN168, RZN173 4X4	08.97 - 08.01			♂	GAS	211884	111884.0			
					♀	GAS	211985	111985.1 111985.2		
KDN145, KDN150	11.01 - 07.05			♂	GAS	211879	111879.0			
					♀	GAS	211997	111997.0		
KDN165, KDN170, KDN190	11.01 - 07.05			♂	GAS	211884	111884.0			
					♀	GAS	211985	111985.1 111985.2		

IQ

 EXCL. EV	(KPJ1_) (GJ11_ UJ1_)	01.09 - 12.15			✓	GAS	210867	110867.1	110867.2		516004
					♂	GAS	211998	111998.0			516010



TOYOTA (J)

LAND CRUISER

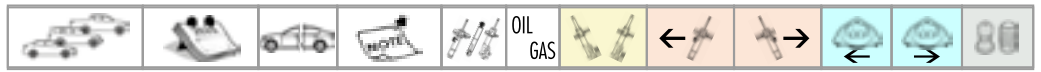







FJ 40, FJ 43, FJ 45 BJ 40, BJ 43		03.69 - 04.86 02.74 - 10.84		⊗	GAS	211367	111367.0			-
				⊗	GAS	211596	111596.0			-
FJ 55, BJ 55		03.69 - 03.71		⊕						
				⊗	OIL	201377	101377.0			-
FJ 42 HJ 45		03.69 - 03.72 04.72 - 07.80		⊗	GAS	211367	111367.0			-
				⊗	GAS	211596	111596.0			-
FJ 55, BJ 55, FJ 56V		04.71 - 07.80		⊕						
				⊗	GAS	211596	111596.0			-
BJ 42, BJ 45, BJ 46 HJ 47		08.80 - 10.84 08.80 - 06.85		⊗	GAS	211367	111367.0			-
				⊗	GAS	211596	111596.0			-
BJ 70, BJ 71, BJ 73 ~		11.84 - 12.89		⊕	GAS	211886	111886.0			
				⊗	GAS	211881	111881.0			-
BJ 75, HJ 75 ~		11.84 - 12.89		⊕	GAS	211886	111886.0			
				⊗						-
LJ 70, LJ 73  RJ 70, RJ 73 		11.84 - 12.89 11.84 - 12.89		⊕	GAS	211887	111887.0			
				⊕	GAS	211888	111888.0			
				⊗	GAS	211248	111248.0			-
BJ 60, FJ 60, FJ 62, HJ 60, HJ 61 Station Wagon (Model#J6##G-)	(WGG)	08.80 - 10.85		⊕	GAS	211889	111889.0			
				⊗	GAS	211596	111596.0			-
BJ 60, FJ 60, FJ 62, HJ 60, HJ 61  (Model#J6##V-)	(WGV)	08.80 - 10.85		⊕	GAS	211886	111886.0			
				⊗	GAS	211596	111596.0			-
BJ 60, FJ 60, FJ 62, HJ 60, HJ 61 Station Wagon (Model#J6##G-)	(WGG)	10.85 - 08.87		⊕	GAS	211889	111889.0			
				⊗	GAS	211248	111248.0			-
BJ 60, FJ 60, FJ 62, HJ 60, HJ 61  (Model#J6##V-)	(WGV)	10.85 - 08.87		⊕	GAS	211886	111886.0			
				⊗	GAS	211248	111248.0			-
HJ 60, HJ 61		08.87 - 12.89		⊕	GAS	211889	111889.0			
				⊗	GAS	211248	111248.0			-
HZJ 70, HZJ 73 ~ PZJ 70, PZJ 73 ~		01.90 - 08.99 01.90 - 08.99		⊕	GAS	211886	111886.0			
				⊗	GAS	211890	111890.0			-
LJ 70/73/77/79, RJ 70/3  LJ70, LJ73, RJ70, KZJ 70 		01.90 - 04.93 05.93 - 12.94		♀	GAS	211891	111891.0			-
				♀	GAS	211892	111892.0			-
HZJ 75, PZJ 75		01.90 - 08.99		⊕	GAS	211886	111886.0			
				⊗	GAS	211991	111991.0			-
HZJ 71, HZJ 74		08.99 - 08.01		⊕	GAS	211987	111987.0			
				⊗	GAS	211890	111890.0			-
HZJ 78		08.99 - 08.01		⊕	GAS	211987	111987.0			
				⊗	GAS	211988	111988.0			-
HZJ 79		08.99 - 08.01		⊕	GAS	211987	111987.0			
				⊗	GAS	211989	111989.0			-
FJ 80, HDJ 80, HZJ 80 		01.90 - 12.98		⊕	GAS	211893	111893.0			
				⊕	GAS	211894	111894.0			
KZJ7#, RJ7#, LJ70, LJ72		05.93 -		♀	GAS	211891	111891.0			-
				♀	GAS	211892	111892.0			-
KZJ 90/95, VZJ 90/95		04.96 - 09.02		♀	GAS	211197	111197.0			
				⊕	GAS	211973	111973.0			
HDJ 100/105, UZJ 100/105 excl. □		01.98 - 08.07		⊕	GAS	211972	111972.0			
				⊕	GAS	211974	111974.0			











TOYOTA (J)

KDJ 120, KDJ 125 excl. 15		09.02 - 03.10			/	GAS	211203	111203.0			
								0	GAS	211990	111990.0



LITE-ACE

	(CR21, KR21, YR22)	01.92 - 01.95			±	GAS	211602	111602.0			
								0			
	(CR27, KR27, YR29)	01.92 - 01.95			±	GAS	211602	111602.0			
								0			
	(KM67)	01.92 - 01.95			±	GAS	211602	111602.0			
								0			



MR-2

	1.6	(AW10, AW11)	11.84 - 06.90			/	GAS	210073	110073.0			516004
									/			
	2.0 16V	(SW20)	12.89 - 05.00			/	GAS	210089	110089.0			516004
									/	GAS	210090	110090.0
	1.8	(W3)	10.99 - 06.07			/	GAS	210856	110856.1	110856.2		516004
									/	GAS	210857	110857.1







PASEO

	(EL54)	08.95 - 07.99			/	GAS	210762	110762.1	110762.2			516004
								/	GAS	211172	111172.0	









PICNIC

	(SXM10, CXM10)	09.96 - 05.01			/	GAS	210836	110836.1	110836.2			516004
								0	GAS	211971	111971.0	



PREVIA

TCR 10, TCR 20 4X2, 4X4 T-T		06.90 - 08.00			/	GAS	210758	110758.1	110758.2			516004
								0	GAS	211897	111897.0	
TCR 11, TCR 21 4X2, 4X4 T-T		06.90 - 08.00			/	GAS	210758	110758.1	110758.2			516004
								±	GAS	211896	111896.0	
	(R30)	04.00 - 01.06			/	GAS	210858	110858.1	110858.2			516004
								0	GAS	211992	111992.0	

PRIUS





























	(HW1)	08.00 - 07.03			/	GAS	210859	110859.1	110859.2			516004
								/	GAS	211204	111204.0	
	(HW2)	08.03 - 03.09			/	GAS	210860	110860.1	110860.2			516004
								/	GAS	211205	111205.0	
	1.8 Hybrid	(ZVW3)	06.08 -			/	GAS	210868	110868.1	110868.2		516004
									0	GAS	211999	111999.0

PROACE VERSO *NEW*

























	(MPY)	02.16 -			/	GAS	212164	112164.0			516004
								0	GAS	212165	112165.0

TOYOTA (J)









RAV-4 / FUN CRUISER

 excl. 235/60 R 16"	(A1)	04.94 - 06.00			GAS	210075	110075.0				516004
					GAS	210861	110861.1	110861.2			
ACA 20, ZCA 25 3p	(A2)	06.00 - 11.05			GAS	210862	110862.1	110862.2			516004
					GAS	211993	111993.0				
ACA 21, ZCA 26 5p	(A2)	06.00 - 11.05			GAS	210863	110863.1	110863.2			516004
					GAS	211993	111993.0				
	(A3)	02.06 - 06.13			GAS	210865	110865.1	110865.2	600420		516004
					GAS	211995	111995.0				-
	(A4)	12.12 -			GAS	210865	110865.1	110865.2			516004
					GAS	211995	111995.0				-
 *NEW*	(A5, H5)	12.18 -			GAS	212244	112244.1	112244.2			
					GAS	212245	112245.0				









STARLET

 1.0, 1.3, 1.3 Turbo	(EP80/1/2)	12.89 - 05.94			GAS	210763	110763.1	110763.2			516004
					GAS	211171	111171.0				
 1.5 D	(NP80)	12.89 - 05.94			GAS	210763	110763.1	110763.2			516004
					GAS	211198	111198.0				
 1.0, 1.3, 1.3 Turbo	(EP80/1/2)	06.94 - 03.96			GAS	210763	110763.1	110763.2			516004
					GAS	211198	111198.0				
 1.5 D	(NP80)	06.94 - 03.96			GAS	210763	110763.1	110763.2			516004
					GAS	211172	111172.0				
 1.3	(EP91)	01.96 - 03.99			GAS	210763	110763.1	110763.2			516004
					GAS	211172	111172.0				





SUPRA / SOARER

3.0 24V	(MA70)	01.86 - 05.93			GAS	211979	111979.0				516004
					GAS	211980	111980.0				
3.0 24V	(JZA80)	05.93 - 01.96			GAS	211981	111981.0				516004
					GAS	211982	111982.0				



















VERSO *NEW*

1.6, 1.8	(R2)	04.09 - 08.18			GAS	212125	112125.1	112125.2			
					GAS	212126	112126.0				
2.0, 2.2	(R2)	04.09 - 08.18			GAS	212127	112127.1	112127.2			
					GAS	212126	112126.0				

VERSO S *NEW*



	(P12)	11.10 -			GAS	212128	112128.1	112128.2			
					GAS	212129	112129.0				

YARIS

 1.0, 1.3	(S/NCP10)	04.99 - 09.05			GAS	210839	110839.0	600670		516004
					GAS	211975	111975.0			
 1.4 TD	(NCP10)	04.99 - 09.05			GAS	210839	110839.0	600670		516004
					GAS	211975	111975.0			
1.5 TS	(NCP13)	01.01 - 09.05			GAS	210839	110839.0	600670		516004
					GAS	211975	111975.0			
	(SCP9, NSP9, KSP9, NCP9, ZSP9)	08.05 - 12.12			GAS	210864	110864.1	110864.2		516004
					GAS	211994	111994.0			



TOYOTA (J)



	(NLP13, NSP13, NCP13, KSP13)	12.10 -			✘	GAS	210864	110864.1	110864.2			516004
					☐	GAS	211994	111994.0				516010

YARIS VERSO









	(NCP20/1/2) (NLP20/22)	08.99 - 09.05			✘	GAS	210840	110840.0		600670		516004
					☐	GAS	211976	111976.0				516010

VAUXHALL (GB)



















AGILA

	(H00)	09.00 - 12.07		/	GAS	210574	110574.1	110574.2	600620	516004
				♀	GAS	211696	111696.0			-



















ASTRA MK I / BELMONT

		09.79 - 08.86		/	OIL	200046	100046.0			
				/	GAS	210046	110046.0			
		09.79 - 08.86		♀	OIL	201662	101662.0			
				/	OIL	200046	100046.0			
		09.79 - 08.86		/	GAS	210046	110046.0			
				♀	OIL	201678	101678.0			-

ASTRA MK II / BELMONT

	excl. GSI, GTE > Ch. J2791967 > Ch. J5273427	09.84 - 07.88		/	OIL	200046	100046.0			516004
				/	GAS	210046	110046.0			
	excl. GSI, GTE Ch. J2791968 > Ch. J5273428 >	08.88 - 08.91		♀	GAS	211662	111662.0			516010
				/	OIL	200046	100046.0			
	Ch. J2791968 > Ch. J5273428 >	08.88 - 08.91		/	GAS	210046	110046.0			516004
				♀	OIL	201663	101663.0			516010
	> Ch. J2791967, > Ch. J5273427	09.84 - 07.88		/	GAS	210046	110046.0			516004
				♀	GAS	211662	111662.0			516010
	Ch. J2791968 >, Ch. J5273428 >	08.88 - 08.91		/	GAS	210046	110046.0			516004
				♀	GAS	211663	111663.0			516010
		09.84 - 08.91		/	OIL	200046	100046.0			516004
				/	GAS	210046	110046.0			
				♀	OIL	201664	101664.0			-
				♀	GAS	211664	111664.0			-

ASTRA MK III

	excl. GT, GSI	09.91 - 09.98		/	OIL	200043	100043.0	600020	516004	
				/	GAS	210043	110043.0			
	GT	09.91 - 09.98		♀	OIL	201663	101663.0		516010	
				♀	GAS	211663	111663.0			
	GSI	09.91 - 09.98		/	GAS	210043	110043.0	600020	516004	
				♀	GAS	211685	111685.0			516010
		09.91 - 09.98		/	OIL	200043	100043.0	600020	516004	
				/	GAS	210043	110043.0			
				♀	OIL	201664	101664.0			-
				♀	GAS	211664	111664.0			-
	excl. 2.0 GSI	09.91 - 09.98		/	GAS	210043	110043.0	600020	516004	
				♀	GAS	211663	111663.0			516010
	2.0 GSI	09.91 - 09.98		/	GAS	210043	110043.0	600020	516004	
				♀	GAS	211663	111663.0			516010

VAUXHALL (GB)

ASTRA MK IV

excl.	04.98 - 04.04				GAS	210562	110562.1	110562.2	600380	516004
					GAS	211689	111689.0			-
,	04.98 - 04.04				GAS	210562	110562.1	110562.2	600380	
					GAS	211690	111690.0			-

ASTRA MK V

,	01.04 - 05.09				GAS	210569	110569.1	110569.2	600160	516004
					GAS	211703	111703.0			-
	08.04 - 05.14				GAS	210569	110569.1	110569.2	600160	516004
					GAS	211702	111702.0			-

BRAVA

TFR Series 4X2	08.91 - 12.02									
										-
TFS Series 4X4	08.91 - 12.02				GAS	211670	111670.0			516004
					GAS	211490	111490.0			-

CALIBRA

2.0, 2.0 16V, 2.5 V6 excl. 2.0 Turbo excl.	06.90 - 08.98									
					GAS	211667	111667.0			516010
					GAS	210044	110044.0		600030	516004
					GAS	211667	111667.0			516010





















CARLTON

	10.78 - 08.86				GAS	210045	110045.0			
					OIL	201675	101675.0			
	10.78 - 08.86				GAS	210045	110045.0			
					GAS	211684	111684.0			
1.8, 2.0, 2.4, excl. 2.3 D, 2.3 TD, excl.	09.86 - 04.94 09.86 - 04.94				GAS	210555	110555.0			516004
					GAS	211682	111682.0			516010
2.6, 3.0, 3.0 24V excl. Lotus,	09.86 - 04.94				GAS	210556	110556.0			516004
					GAS	211682	111682.0			516010
 excl.	09.86 - 04.94				GAS	210555	110555.0			516004
					GAS	211683	111683.0			516010









CAVALIER

	1975 - 08.81				OIL	201661	101661.0			
					GAS	211660	111660.0			
> Ch. F1003026 > Ch. F5000000 > Ch. F6000000	09.81 - 12.85				GAS	210041	110041.0			
					OIL	201662	101662.0			
					GAS	211662	111662.0			
Ch. F1003027 > Ch. F5000001 > Ch. F6000001 >	01.85 - 08.88				GAS	210042	110042.0			516004
					OIL	201662	101662.0			516010
					GAS	211662	111662.0			
, 1.4, 1.4, 1.6, 1.6, 1.7 D , 1.8, 1.8, 2.0, 1.7 TD excl. 4X4	09.88 - 11.95				GAS	210044	110044.0		600030	
					OIL	201662	101662.0			
					GAS	211662	111662.0			
, 2.0 16V excl. 4X4 > Ch. NV199999, N1999999, N5999999	09.88 - 12.92				GAS	210044	110044.0		600030	
					GAS	211682	111682.0			









VAUXHALL (GB)

  2.0 16V excl. 4X4 Ch. NV199999, N1999999, N5999999 >	01.93 - 11.95		/	GAS	210044	110044.0	600030		
					excl. 		OIL	201663	101663.0
  1.8, 2.0, 2.0 16V excl. Turbo 4X4	09.88 - 11.95		/	GAS	210044	110044.0	600030		
					excl. 		GAS	211682	111682.0
 > Ch. F1003026, F5000000, F6000000	09.81 - 12.85 09.81 - 12.85 09.81 - 12.85		/	GAS	210041	110041.0			516004
									
 Ch. F1003027, F5000001, F6000001 >	01.85 - 08.88 01.85 - 08.88 01.85 - 08.88		/	GAS	210042	110042.0			516004
									

























































CHEVETTE

	03.75 - 12.85			OIL	201661	101661.0			
						OIL	201675	101675.0	
 	03.75 - 12.85			OIL	201661	101661.0			
						GAS	211674	111674.0	

COMBO





	07.94 - 10.01			GAS	210554	110554.0	600370		516004	
						OIL	201679	101679.0		
 Van, Tour	10.01 - 12.11			GAS	210566	110566.1	110566.2	600380		516004
						GAS	211699	111699.0		

CORSA















 incl. CorsaVan excl. GSI	03.93 - 09.00			GAS	210554	110554.0	600370		516004	
						GAS	211671	111671.0		
 GSI, GSI 16V	03.93 - 09.00			GAS	210554	110554.0	600370		516004	
						GAS	211671	111671.0		
 1.0, 1.2 excl. 	09.00 -			GAS	210566	110566.1	110566.2	600380		516004
					33A		GAS	211695	111695.0	
 1.0, 1.2 	09.00 -			GAS	210566	110566.1	110566.2	600380		516004
					33B		GAS	211698	111698.0	
 1.7 Di excl. 	09.00 -			GAS	210566	110566.1	110566.2	600380		516004
					33A		GAS	211695	111695.0	
 1.7 Di 	09.00 -			GAS	210566	110566.1	110566.2	600380		516004
					33B		GAS	211698	111698.0	
 1.4 excl. 	09.00 -			GAS	210566	110566.1	110566.2	600380		516004
					33B		GAS	211698	111698.0	
 1.4 	09.00 -			GAS	210566	110566.1	110566.2	600380		516004
					33B		GAS	211698	111698.0	
 1.8, 1.7DTi excl. 	09.00 -			GAS	210566	110566.1	110566.2	600380		516004
					33B		GAS	211698	111698.0	
 1.8, 1.7DTi 	09.00 -			GAS	210566	110566.1	110566.2	600380		516004
					33B		GAS	211698	111698.0	

VAUXHALL (GB)





CORSA MK IV

		07.06 -				GAS	210571	110571.1	110571.2	600500	516004
						GAS	211704	111704.0	600781	600782	















FRONTERA

	incl. sport ~ , > Ch. SV720102	03.92 - 02.95				GAS	211644	111644.0			516004
						GAS	211676	111676.0			-
	incl. sport ~ , Ch. SV720103 >	02.95 - 10.98				GAS	211687	111687.0			516004
						GAS	211676	111676.0			-
	incl. sport	11.98 - 07.04				GAS	211692	111692.0			516004
						GAS	211693	111693.0			











MERIVA

		01.03 - 03.10				GAS	210566	110566.1	110566.2	600380	516004
						GAS	211699	111699.0			-











MONTEREY

		09.91 - 03.95				GAS	211670	111670.0			516004
						GAS	211680	111680.0			-
		04.95 - 07.98				GAS	211688	111688.0			516004
						GAS	211680	111680.0			-
		07.98 - 08.99				GAS	211707	111707.0			516004
						GAS	212001	112001.0			-





















MOVANO

	2.8T, 3.3T, 3.5T	(E9, F9, J9)	07.98 -				GAS	211789	111789.0			-
							GAS	211790	111790.0			-
	3.5T	(H9, U9)	07.98 -				GAS	211789	111789.0			-
							OIL	201791	101791.0			-

NOVA











	incl. NovaVan excl. GT, GTE, GSI	05.83 - 03.93				GAS	210554	110554.0	600370	516004
						GAS	211671	111671.0		
	GT, GTE, GSI	01.88 - 03.93				GAS	210554	110554.0	600370	516004
						GAS	211671	111671.0		

OMEGA





	2.0, 2.0 16V, 2.2 16V excl. †	05.94 - 07.03				GAS	210557	110557.0			516004
						GAS	211682	111682.0			
	2.5 V6, 2.6 V6, 3.0 V6, 3.2 V6, excl. †	05.94 - 07.03				GAS	210558	110558.0			516004
						GAS	211682	111682.0			
	2.0, 2.0 16V, 2.2 16V excl. †	05.94 - 07.03				GAS	210557	110557.0			516004
						GAS	211683	111683.0			
	2.5 V6, 2.6 V6, 3.0 V6, 3.2 V6, excl. †	05.94 - 07.03				GAS	210558	110558.0			516004
						GAS	211683	111683.0			

VAUXHALL (GB)

















RASCAL

		1986 -				OIL	200178	100178.1	100178.2			
						OIL	201314	101314.0				
		1986 -				OIL	200178	100178.1	100178.2			
						OIL	201315	101315.0				







ROYALE

 excl. 		02.78 - 08.87				GAS	210045	110045.0				
												





SENATOR

 excl. 		02.78 - 08.87				GAS	210045	110045.0				
												
 excl. 3.0 24V, 		09.87 - 04.94				GAS	210555	110555.0				
						GAS	211682	111682.0				
 3.0 24V excl. 		09.87 - 04.94				GAS	210556	110556.0				
						GAS	211682	111682.0				

























SINTRA

		11.96 - 04.99				GAS	210563	110563.0				516004
				excl. 		GAS	211691	111691.0				-















TIGRA

 1.4 16V, 1.6 16V		07.94 - 12.00				GAS	210554	110554.0		600370		516004
						GAS	211671	111671.0				





VECTRA MK I

 1.6, 1.8, 2.0		08.95 - 08.02				GAS	210560	110560.1	110560.2	600380		516004
						GAS	211130	111130.0				516010
 1.7 TD, 2.0 DTi  2.5 V6		01.96 - 08.02				GAS	210561	110561.1	110561.2	600380		
		08.95 - 08.02				GAS	211130	111130.0				
 1.6, 1.8, 2.0		08.95 - 08.02				GAS	210560	110560.1	110560.2	600380		516004
				excl. 		GAS	211130	111130.0				
 1.7 TD, 2.0 DTi  2.5 V6		08.95 - 08.02				GAS	210561	110561.1	110561.2	600380		516004
		08.95 - 08.02		excl. 		GAS	211131	111131.0				

VECTRA MK II

 excl. 3.0 CDTi excl.  		04.02 - 08.04				GAS	210567	110567.1	110567.2	600770		516004
						GAS	211700	111700.0				-
 excl. 3.0 CDTi  		04.02 - 08.04				GAS	210568	110568.1	110568.2	600770		516004
						GAS	211701	111701.0				-



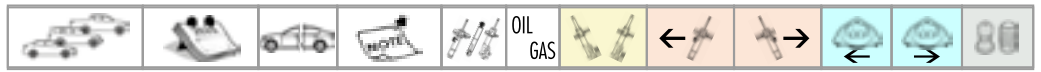

VIVARO

		08.01 -				GAS	210648	110648.0		600150		516004
						GAS	211804	111804.0				-







VAUXHALL (GB)

ZAFIRA

 excl. 2.0 Turbo OPC		04.99 - 07.05			GAS	210564	110564.1	110564.2	600380	516004
					GAS	211694	111694.0			

ZAFIRA MK II

		07.05 -			GAS	210569	110569.1	110569.2	600160	516004
					GAS	211703	111703.0			

VOLKSWAGEN (D)

BEETLE

Assale rigido, multilink	(5C1, 5C2, 5C7, 5C8) (1Y7)	04.11 - 07.19		5B		GAS	210127	110127.0	600430	516004
				5A		GAS	210776	110776.0		
						GAS	211916	111916.0		516010

BORA

excl. 2.3 V5 excl.	(1J2)	10.98 - 05.05		4A		OIL	200772	100772.0	600270	516004
						GAS	210772	110772.0		
2.3 V5	(1J2)	10.98 - 05.05 10.98 - 05.05		4B		OIL	200124	100124.0	600270	516004
						GAS	210124	110124.0		
4motion 4X4 excl. > Ch. 1J-X-999000	(1J2)	10.98 - 04.99		4B		OIL	200124	100124.0	600270	516004
						GAS	210124	110124.0		
4motion 4X4 excl. Ch. 1J-X-999001 >	(1J2)	05.99 - 05.05		4B		GAS	210125	110125.0	600270	516004
						GAS	211846	111846.0		-
4motion 4X4 	(1J2)	05.99 - 05.05		4B		GAS	210125	110125.0	600270	516004
						GAS	211914	111914.0		-
excl. 2.3 V5 excl. , 4motion 4X4	(1J6)	05.99 - 05.05		4A		OIL	200772	100772.0	600270	516004
						GAS	210772	110772.0		
2.3 V5, excl. 4motion 4X4	(1J6)	05.99 - 05.05		4B		GAS	210124	110124.0	600270	516004
						GAS	211913	111913.0	600290	516010
4motion 4X4 excl.	(1J2)	05.99 - 05.05		4B		GAS	210125	110125.0	600270	516004
						GAS	211846	111846.0		-
4motion 4X4 	(1J2)	05.99 - 05.05		4B		GAS	210125	110125.0	600270	516004
						GAS	211914	111914.0		-

CADDY I

	(14)	08.82 - 07.92				OIL	200077	100077.0			516004
						GAS	210077	110077.0			
						OIL	201413	101413.0		-	

CADDY II

	(9K9A)	11.95 - 01.04		40C		OIL	200771	100771.0	600050	516004
						GAS	210771	110771.0		
						OIL	201840	101840.0		-
	(9U7)	06.96 - 12.00								

CADDY III

excl. Maxi	(2KA)	03.04 - 05.01		5A		GAS	210776	110776.0	600430	516007
				5B		GAS	210127	110127.0		516004
						GAS	211918	111918.0		-
incl. maxi excl. 4WD,	(2K_, 2C_)	08.10 - 05.15 04.04 - 05.15		5B		GAS	210127	110127.0	600430	516007
				5A		GAS	210776	110776.0		516004
						GAS	211926	111926.0		-

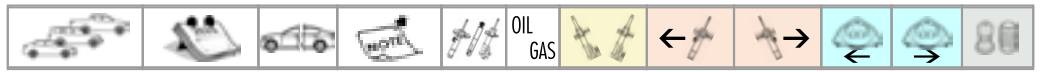

VOLKSWAGEN (D)

incl. maxi, 4WD excl.	(2K_, 2C_)	05.08 - 05.15		5B		GAS	210127	110127.0	600430	516007
				5A		GAS	210776	110776.0		516004
						GAS	211927	111927.0		-

CADDY IV

incl. maxi excl. 4WD,	(SAB, SAJ)	05.15 -		5B		GAS	210127	110127.0	600430	516007
				5A		GAS	210776	110776.0		516004
						GAS	211918	111918.0		-

CORRADO

1.8 16V, 1.8 660 2.0, 2.0 16V	(53I)	08.87 - 12.95 08.91 - 12.95				GAS	210078	110078.0	600040	516004
				40E		GAS	210767	110767.0		
2.9 VR6	(53I)	09.91 - 12.95				GAS	211175	111175.0	600700	
				40B		GAS	210769	110769.0	600040	516004
						GAS	211175	111175.0	600700	

CRAFTER

30 excl. H.D.		04.06 - 12.16				GAS	210507	110507.0	600220	516007
						GAS	211584	111584.0		-
30 incl. H.D.		04.06 - 12.16				GAS	210509	110509.0	600220	516007
										-
35 excl. H.D. excl.		04.06 - 12.16				GAS	210507	110507.0	600220	516007
						GAS	211584	111584.0		-
35 incl. H.D. incl.		04.06 - 12.16				GAS	210507	110507.0	600220	516007
										-
50 incl. H.D. excl.		04.06 - 12.16				GAS	210509	110509.0	600220	516007
						GAS	211586	111586.0		-
50 incl.		04.06 - 12.16				GAS	210509	110509.0	600220	516007
										-

DERBY

	(86, 86C, 80)	02.77 - 12.84				OIL	200002	100002.0		516004
						GAS	210002	110002.0		
						OIL	200993	100993.0		
						GAS	210993	110993.0		

EOS

	(1F7, 1F8)	06.06 - 08.15		5A		GAS	210776	110776.0	600430	516007
				5B		GAS	210127	110127.0		516004
						GAS	211921	111921.0		516010

FOX

1.2, 1.4i, 1.4 TDi	(5Z1)	04.05 - 12.11		4A		GAS	210694	110694.0	600350	516004
						GAS	211920	111920.0	600290	516010

GOLF I

excl. , H.D.	(17)	04.74 - 05.77				OIL	200077	100077.0		516004
						GAS	210077	110077.0		
						OIL	201173	101173.0		
						GAS	211173	111173.0		

VOLKSWAGEN (D)

excl. , H.D.	(17)	05.77 - 08.83		/	OIL	200077	100077.0			516004
					GAS	210077	110077.0			
				/	OIL	201173	101173.0			
					GAS	211173	111173.0			

GOLF II







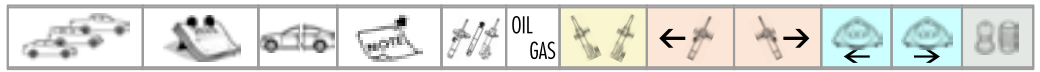



























N.D. excl. 1.8 GTI 16V, 1.8 G60, Syncro 4X4, Country	(19E, 1G1)	09.83 - 12.89		40A	/	OIL	200078	100078.0	600040	516004							
					/	OIL	200768	100768.0									
					/	GAS	210078	110078.0									
					/	GAS	210768	110768.0									
				/	OIL	201174	101174.0	600700	516010								
					GAS	211174	111174.0										
					excl. 1.8 GTI 16V, 1.8 G60, Syncro 4X4, Country	(19E, 1G1)	01.90 - 08.91				40A	/	OIL	200078	100078.0	600040	516004
												/	OIL	200768	100768.0		
/	GAS	210078	110078.0														
/	GAS	210768	110768.0														
	/	OIL	201174	101174.0				600700	516010								
		GAS	211174	111174.0													
		1.8 GTI 16V	(19E, 1G1)	09.83 - 12.89							/	GAS	210079	110079.0	600040	516004	
			/	GAS						211175	111175.0	600700	516010				
1.8 GTI 16V	(19E, 1G1)	01.90 - 08.91		40D	/	GAS	210766	110766.0	600040	516004							
					/	GAS	211175	111175.0	600700	516010							
1.8 G60 excl. Syncro 4X4	(19E, 1G1)	04.90 - 08.91		40D	/	GAS	210767	110767.0	600040	516004							
					/	GAS	211175	111175.0	600700	516010							
1.8 Syncro 4X4 excl. Country	(19E, 1G1)	02.86 - 12.89		/	OIL	200078	100078.0	600040	516004								
					GAS	210078	110078.0										
				/	GAS	211161	111161.0	600700	516010								
					1.8 Syncro 4X4 excl. Country, Rallye	(19E, 1G1)	01.90 - 08.91		40A	/	OIL	200768	100768.0	600040	516004		
/	GAS	210768	110768.0														
	/	GAS	211161	111161.0				600700	516010								

GOLF III

























excl. 1.8 GT, 1.9 TD/TDI, GTI, VR6, Syncro 4X4 > Ch. 1H SW062 538 > Ch. 1H SB019 475	(1H1)	09.91 - 08.94		40A	/	OIL	200768	100768.0	600040	516004
					/	GAS	210768	110768.0		
				/	OIL	201174	101174.0	600700	516010	
					GAS	211174	111174.0			
excl. 1.8 GT, 1.9 TD/TDI, GTI, VR6, Syncro 4X4 Ch. 1H SW062 539 > Ch. 1H SB019 476 >	(1H1)	09.94 - 08.97		40C	/	OIL	200771	100771.0	600050	516004
					/	GAS	210771	110771.0		
				/	OIL	201174	101174.0	600700	516010	
					GAS	211174	111174.0			
1.8 GT, 1.9 TD/TDI > Ch. 1H SW062 538 > Ch. 1H SB019 475	(1H1)	09.91 - 08.94		40A	/	GAS	210768	110768.0	600040	516004
					/	GAS	211174	111174.0		
				/	GAS	211174	111174.0	600700	516010	
					1.8 GT, 1.9 TD/TDI Ch. 1H SW062 539 > Ch. 1H SB019 475 >	(1H1)	09.94 - 08.97		40C	/
/	GAS	211174	111174.0							
	/	GAS	211174	111174.0				600700	516010	



VOLKSWAGEN (D)

↳ 1.8, 2.0 Syncro 4X4 > Ch. 1H SW062 538 > Ch. 1H SB019 475	(1H1)	01.93 - 08.94 01.93 - 08.94		40A		OIL	200768	100768.0	600040	516004
						GAS	210768	110768.0		
	(1H1)	09.94 - 08.97 09.94 - 08.97		40C		OIL	200771	100771.0	600050	516004
						GAS	210771	110771.0		
↳ 2.0 GTI, 2.0 GTI 16V	(1H1)	09.91 - 08.97		40B		OIL	210769	110769.0	600040	516004
						GAS	211175	111175.0		
↳ 2.8 VR6	(1H1)	09.91 - 08.97		40B		OIL	210769	110769.0	600040	516004
						GAS	211175	111175.0		
↳ excl. 2.0, 2.8 VR6 > Ch. 1H SW062538 > Ch. 1H SB019475	(1H5)	09.93 - 08.94		40A		OIL	200768	100768.0	600040	516004
						GAS	210768	110768.0		
↳ excl. 2.0, 2.8 VR6 Ch. 1H SW062539 > Ch. 1H SB019475 >	(1H5)	09.94 - 04.99		40C		OIL	200771	100771.0	600050	516004
						GAS	210771	110771.0		
↳ 2.0	(1H5)	09.93 - 04.99		40B		OIL	210769	110769.0	600040	516004
						GAS	211179	111179.0		
↳ 1.6, 1.8, 1.9 TDI	(1E7)	09.93 - 08.94		40A		OIL	200768	100768.0	600040	516004
						GAS	210768	110768.0		
						OIL	201174	101174.0	600700	516010
						GAS	211174	111174.0		
↳ 1.6, 1.8, 1.9 TDI	(1E7)	09.94 - 05.98		40C		OIL	200771	100771.0	600050	516004
						GAS	210771	110771.0		
						OIL	201174	101174.0	600700	516010
						GAS	211174	111174.0		
↳ 2.0	(1E7)	09.93 - 05.98		40B		OIL	210769	110769.0	600040	516004
						GAS	211174	111174.0		

GOLF IV

↳ 1.4, 1.6, 2.0, 1.9 SDI, 1.9 TDI excl. ⚙, 4motion 4X4, ⚙ 16"	(1J1)	08.97 - 06.05		4A		OIL	200772	100772.0	600270	516004
						GAS	210772	110772.0		
↳ 1.4, 1.6, 2.0, 1.9 SDI, 1.9 TDI ⚙ excl. 4motion 4X4, ⚙ 16"	(1J1)	08.97 - 06.05		4B		GAS	210124	110124.0	600270	516004
						GAS	211252	111252.0		
↳ 1.8, 1.8 Turbo, 2.3 V5, 2.8 V6 excl. ⚙, 4motion 4X4, ⚙ 16"	(1J1)	08.97 - 06.05		4B		GAS	210124	110124.0	600270	516004
						GAS	211252	111252.0		
↳ 4motion 4X4 excl. ⚙ 16"	(1J1)	07.98 - 06.05		4B		GAS	210124	110124.0	600270	516004
						GAS	211256	111256.0		
↳ 4motion 4X4 excl. ⚙ 16"	(1J1)	06.99 - 10.03		4B		GAS	210125	110125.0	600270	516004
						GAS	211256	111256.0		
↳ 1.4, 1.6, 1.9 SDI, 1.9 TDI excl. ⚙, ⚙ 16"	(1J5)	05.99 - 06.06		4A		OIL	200772	100772.0	600270	516004
						GAS	210772	110772.0		
↳ 1.4, 1.6, 1.9 SDI, 1.9 TDI ⚙ excl. ⚙ 16"	(1J5)	05.99 - 06.06		4B		GAS	211913	111913.0	600290	516010
						GAS	210124	110124.0		
↳ 1.8, 1.8 Turbo, 2.3 V5 excl. ⚙ 16"	(1J5)	05.99 - 06.06		4B		GAS	210124	110124.0	600270	516004
						GAS	211913	111913.0		

VOLKSWAGEN (D)

GOLF V

excl. GTI,	(1K1)	10.03 - 12.08		5A		GAS	210776	110776.0	600430	516007
				5B		GAS	210127	110127.0		516004
						GAS	211916	111916.0		516010
	(1K1)	01.05 - 12.08		5A		GAS	210777	110777.0	600430	516007
				5B		GAS	210128	110128.0		516004
						GAS	211260	111260.0		516010
Plus	(5M1, 521)	01.05 - 12.13		5A		GAS	210776	110776.0	600430	516007
				5B		GAS	210127	110127.0		516004
						GAS	211916	111916.0		516010
excl.	(1K5)	06.07 - 07.09		5A		GAS	210776	110776.0	600430	516007
				5B		GAS	210127	110127.0		516004
						GAS	211916	111916.0		516010
	(1K5)	06.07 - 07.09		5A		GAS	210777	110777.0	600430	516007
				5B		GAS	210128	110128.0		516004
						GAS	211260	111260.0		516010

GOLF VI

, , excl.	(5K1, AJ5)	10.08 - 11.12 07.09 - 11.12		5A		GAS	210776	110776.0	600430	516007
				5B		GAS	210127	110127.0		516004
						GAS	211916	111916.0		516010
, , incl.	(5K1, AJ5)	10.08 - 11.12 07.09 - 11.12		5A		GAS	210777	110777.0	600430	516007
				5B		GAS	210128	110128.0		516004
						GAS	211260	111260.0		516010

GOLF VII

, excl. 4X4, R,	(5G1, BA5)	11.12 - 04.13 -		5A		GAS	210785	110785.0		516007
				5B		GAS	210784	110784.0		516004
						GAS	211924	111924.0		516010
, incl. 4X4 excl. R,	(5G1, BA5)	11.12 - 04.13 -		5A		GAS	210785	110785.0		516007
				5B		GAS	210784	110784.0		516004
						GAS	211925	111925.0		516010

























GOLF VIII *NEW*

, excl. 4X4, R,	(CD1)	12.19 -		5A		GAS	210785	110785.0		516007
				5B		GAS	210784	110784.0		516004
						GAS	211924	111924.0		516010
, incl. 4X4 excl. R,	(CD1)	12.19 -		5A		GAS	210785	110785.0		516007
				5B		GAS	210784	110784.0		516004
						GAS	211925	111925.0		516010











JETTA

	(17, 16)	01.73 - 05.77				OIL	200077	100077.0		516004
						GAS	210077	110077.0		
						OIL	201173	101173.0		516010
						GAS	211173	111173.0		



VOLKSWAGEN (D)

	(17, 16)	06.77 - 08.83			/	OIL	200077	100077.0			516004		
					/	GAS	210077	110077.0					
					/	OIL	201173	101173.0			516010		
					/	GAS	211173	111173.0					
 excl. 1.8 GTI 16V, Syncro 4X4, H.D.	(19E, 162)	09.83 - 12.92		40A	/	OIL	200078	100078.0	600040		516004		
					/	OIL	200768	100768.0					
					/	GAS	210078	110078.0					
					/	GAS	210768	110768.0					
								/	OIL	201174	101174.0	600700	516010
								/	GAS	211174	111174.0		
 1.8 GTI 16V	(19E, 162)	09.83 - 12.89			/	GAS	210079	110079.0	600040	516004			
						/	GAS	211175	111175.0	600700	516010		
 1.8 GTI 16V	(19E, 162)	01.90 - 12.92		40C	/	GAS	210766	110766.0	600040	516004			
						/	GAS	211175	111175.0	600700	516010		
 1.8 Syncro 4X4	(19E, 162)	08.87 - 12.89			/	OIL	200078	100078.0	600040	516004			
					/	GAS	210078	110078.0					
								/	GAS	211161	111161.0	600700	516010
 1.8 Syncro 4X4	(19E, 162)	01.90 - 07.91		40A	/	OIL	200768	100768.0	600040	516004			
					/	GAS	210768	110768.0					
								/	GAS	211161	111161.0	600700	516010
 excl. ❌	(1K2)	09.05 - 10.10		5A	/	GAS	210776	110776.0	600430	516004			
					/	GAS	210127	110127.0					
								/	GAS	211916	111916.0		516010
	(162)	04.10 -		5A	/	GAS	210776	110776.0	600430	516004			
					/	GAS	210127	110127.0					
								/	GAS	211916	111916.0		516010

LT SERIES

LT 28, LT 28 D, LT 31, LT 31 D, LT 35, LT 35 D	(281, 363)	04.75 - 12.82			⊥	OIL	201903	101903.0			
					∅	OIL	201910	101910.0			
LT 28, LT 28 D, LT 31, LT 31 D, LT 35, LT 35 D	(281, 363)	12.82 - 12.96			⊥	OIL	201903	101903.0			
					∅	OIL	201904	101904.0			
LT 40, LT 40 D, LT 45, LT 45 D	(291, 293, 512, 909)	01.75 - 12.82			∅	OIL	201911	101911.0			
					∅	OIL	201910	101910.0			
LT 40, LT 40 D, LT 40 TD LT 45, LT 45 D, LT 45 TD LT 55, LT 55 D, LT 55 TD 4X2, 4X4	(291, 293, 512, 909)	01.83 - 12.96 08.85 - 12.96 08.85 - 12.96			∅	OIL	201911	101911.0			
						∅					
 excl. LT 46	(2DM)	04.96 - 07.06			/	GAS	210779	110779.0			
						∅	GAS	211565			
 LT46	(2DX0AE/FE)	04.96 - 07.06			/	GAS	210498	110498.0			
						∅	OIL	201566			

LUPO

	(6X1, 6E1)	09.98 - 07.05		40C	/	OIL	200771	100771.0	600050		516004
					/	GAS	210771	110771.0			
								/	GAS	211841	111841.0

VOLKSWAGEN (D)

MULTIVAN T5

	(7H, 7E)	04.03 - 08.15				GAS	210781	110781.0			516004
						GAS	211919	111919.0			-

MULTIVAN T6

excl. 4x4	(SGF, SGM, SGN)	04.15 -				GAS	211919	111919.0			-
						GAS	211919	111919.0			-

NEW BEETLE

	(9C1, 1C1)	01.98 - 09.10		4B		GAS	210124	110124.0	600270	516004
						GAS	211252	111252.0	600290	516010
	(1Y7)	01.03 - 10.10		4B		GAS	210124	110124.0	600270	516004
						GAS	211252	111252.0	600290	516010

PASSAT I

	(32, 33)	05.73 - 09.80				OIL	200003	100003.0			516004
						OIL	201249	101249.0			-

PASSAT II







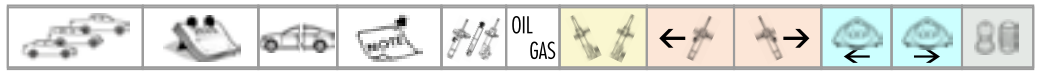

excl. Syncro 4X4	(32B)	10.80 - 06.89				GAS	210004	110004.0			516004
						GAS	211176	111176.0			516010

PASSAT III





























































excl. 2.8 VR6, Syncro 4X4, excl. 2.8 VR6, Syncro,	(3A2, 351) (3A5, 351)	02.88 - 07.91 02.88 - 07.91		40E		OIL	200080	100080.0	600040	516004
						OIL	200767	100767.0		
						GAS	210080	110080.0		
						GAS	210767	110767.0		
						OIL	201177	101177.0		
						GAS	211177	111177.0		
 excl. 2.8 VR6, Syncro 4X4, > Ch. 026435	(3A2, 3A5, 351)	08.91 - 05.97		40D		OIL	200767	100767.0	600040	516004
						GAS	210767	110767.0		
						OIL	201177	101177.0		
						GAS	211177	111177.0		
						OIL	201177	101177.0		
						GAS	211177	111177.0		
 excl. 2.8 VR6, Syncro 4X4, Ch. 026436 >	(3A2, 3A5, 351)	08.91 - 05.97		40F		OIL	200770	100770.0	600040	516004
						GAS	210770	110770.0		
						OIL	201177	101177.0		
						GAS	211177	111177.0		
						OIL	201177	101177.0		
						GAS	211177	111177.0		
2.8 VR6 excl.	(3A2, 3A5, 351)	08.91 - 08.96		40F		GAS	210770	110770.0	600040	516004
						GAS	211177	111177.0		
						OIL	201177	101177.0		
						GAS	211177	111177.0		
						OIL	200080	100080.0		
						OIL	200767	100767.0		
Syncro 4X4 excl. Syncro 4X4 excl.	(3A2, 351) (3A5, 351)	08.88 - 07.91 08.88 - 07.91		40E		GAS	210080	110080.0	600040	516004
						GAS	210767	110767.0		
						GAS	211178	111178.0		
						GAS	211178	111178.0		
						OIL	200767	100767.0		
						GAS	210767	110767.0		
Syncro 4X4 excl. > Ch. 026435	(3A2, 351)	08.91 - 08.96		40E		OIL	200767	100767.0	600040	516004
						GAS	211178	111178.0		



VOLKSWAGEN (D)

 Syncro 4X4 excl. □ > Ch. 026435	(3A5, 351)	08.91 - 12.92		40E		OIL	200767	100767.0	600040	516004
						GAS	210767	110767.0		
						GAS	211178	111178.0		516010
 Syncro 4X4 excl. □ Ch. 026436 >	(3A2, 351)	01.92 - 08.96		40F		OIL	200770	100770.0	600040	516004
						GAS	210770	110770.0		
						GAS	211178	111178.0		516010

PASSAT IV

 1.6, 1.8, 1.8 Turbo, 2.0, 1.9 TDI excl. Syncro 4X4 > Ch. 3B-YE121221	(3B2)	08.96 - 09.99				GAS	210999	110999.0	600060	516001
						GAS	211253	111253.0		516010
 2.3 VR5, 2.8 V6, 2.5 V6 TDI excl. Syncro 4X4 > Ch. 3B-YE121221	(3B2)	08.96 - 09.99				GAS	211001	111001.0	600060	516001
						GAS	211253	111253.0		516010
 1.6, 1.8, 2.0, 1.8 Turbo, 1.9 TDI, 2.3 VR5 Excl. Syncro 4X4 Ch. 3B-YE121222 >	(3B3)	09.99 - 12.05		N.D.		GAS	211008	111008.0	600060	516001
				H.D.		GAS	211009	111009.0		
						GAS	211253	111253.0		516010
 2.5 V6 TDI, 2.8 V6 Excl. Syncro 4X4 Ch. 3B-YE121222 >	(3B3)	09.99 - 12.05				GAS	211009	111009.0	600060	516001
						GAS	211253	111253.0		516010
 1.6, 1.8, 2.0, 1.8 Turbo, 1.9 TDI, 2.3 VR5 Syncro, 4motion 4X4 Ch. 3B-YE121222 >	(3B3)	09.99 - 12.05		N.D.		GAS	211008	111008.0	600060	516001
				H.D.		GAS	211009	111009.0		
						GAS	211010	111010.0		516010
 2.5 V6 TDI, 2.8 V6 Syncro, 4motion 4X4 Ch. 3B-YE121222 >	(3B3)	09.99 - 12.05				GAS	211009	111009.0	600060	516001
						GAS	211010	111010.0		516010
 1.6, 1.8, 1.8 Turbo, 2.0, 1.9 TDI excl. Syncro 4X4 > Ch. 3B-YE121221	(3B5)	06.97 - 09.99				GAS	210999	110999.0	600060	516001
						GAS	211253	111253.0		516010
 2.3 VR5, 2.8 V6, 2.5 V6 TDI excl. Syncro 4X4 > Ch. 3B-YE121221	(3B5)	06.97 - 09.99				GAS	211001	111001.0	600060	516001
						GAS	211253	111253.0		516010
 1.6, 1.8, 2.0, 1.8 Turbo, 1.9 TDI, 2.3 VR5 Excl. Syncro 4X4 Ch. 3B-YE121222 >	(3B6)	09.99 - 12.05		N.D.		GAS	211008	111008.0	600060	516001
				H.D.		GAS	211009	111009.0		
						GAS	211253	111253.0		516010
 2.5 V6 TDI, 2.8 V6 Excl. Syncro 4X4 Ch. 3B-YE121222 >	(3B6)	09.99 - 12.05				GAS	211009	111009.0	600060	516001
						GAS	211253	111253.0		516010
 1.6, 1.8, 2.0, 1.8 Turbo, 1.9 TDI, 2.3 VR5 Syncro, 4motion 4X4 Ch. 3B-YE121222 >	(3B6)	09.99 - 12.05		N.D.		GAS	211008	111008.0	600060	516001
				H.D.		GAS	211009	111009.0		
						GAS	211010	111010.0		516010
 2.5 V6 TDI, 2.8 V6 Syncro, 4motion 4X4 Ch. 3B-YE121222 >	(3B6)	09.99 - 12.05				GAS	211009	111009.0	600060	516001
						GAS	211010	111010.0		516010

VOLKSWAGEN (D)

PASSAT V

🚗 excl. ☒	(3C2)	03.05 - 08.10			GAS	210776	110776.0	600430	516007
					GAS	211916	111916.0		516010
🚗 ☒	(3C2)	03.05 - 08.10			GAS	210777	110777.0	600430	516007
					GAS	211260	111260.0		516010

PASSAT CC

🚗 excl. ☒	(357)	06.08 - 01.12			GAS	210776	110776.0	600430	516007
					GAS	211916	111916.0		516010
🚗 incl. ☒	(357)	06.08 - 01.12			GAS	210777	110777.0	600430	516007
					GAS	211260	111260.0		516010

PASSAT VI

🚗, 🚗 excl. ☒	(362, 365)	08.10 - 12.14			GAS	210776	110776.0	600430	516007
					GAS	211916	111916.0		516010
🚗, 🚗 incl. ☒	(362, 365)	08.10 - 12.14			GAS	210777	110777.0	600430	516007
					GAS	211260	111260.0		516010
🚗 Alltrack excl. ☒, ☒, ☒	(365)	01.12 - 12.14			GAS	210776	110776.0	600430	516007
					GAS	211916	111916.0		516010
🚗 Alltrack incl. ☒	(365)	01.12 - 12.14			GAS	210777	110777.0	600430	516007
					GAS	211260	111260.0		516010

PASSAT VII

🚗, 🚗 excl. ☒, ☒, ☒, Alltrack	(362, 365)	08.14 -			GAS	210785	110785.0		516007
					GAS	211924	111924.0		516010

POLO I / II

🚗 excl. 1.3 G40	(86, 86C, 80)	03.75 - 08.94				OIL	200002	100002.0		
						GAS	210002	110002.0		
						OIL	200993	100993.0		
						GAS	210993	110993.0		
🚗 1.3 G40	(86, 86C, 80)	01.87 - 08.94								

POLO III

🚗 excl. 1.6 16V GTI	(6N1, 6N2)	09.94 - 06.96		40C		OIL	200771	100771.0	600050	516004
						GAS	210771	110771.0		
						OIL	201180	101180.0	600700	516010
						GAS	211180	111180.0		
🚗 excl. 1.6 16V GTI	(6N1, 6N2)	07.96 - 11.01		40C		OIL	200771	100771.0	600050	516004
						GAS	210771	110771.0		
						OIL	201180	101180.0	600700	516010
						GAS	211180	111180.0		
🚗 1.6 16V GTI	(6N1, 6N2)	09.94 - 11.01							516004	
					OIL	201180	101180.0	600700	516010	
						GAS	211180	111180.0		

VOLKSWAGEN (D)

Classic, Flight	(6KV2)	09.94 - 06.96		40C		OIL	200771	100771.0	600050	516004
						GAS	210771	110771.0		
Classic, Flight	(6KV2)	07.96 - 09.01		40C		OIL	201161	101161.0	600700	516010
						GAS	211161	111161.0		
Variant	(6KV5)	04.97 - 09.01		40C		OIL	200771	100771.0	600050	516004
						GAS	210771	110771.0		
Caddy	(6NF)	10.94 - 12.99		40C		OIL	200771	110771.0	600050	516004
						GAS	210771	110771.0		
						OIL	211840	111840.0		

POLO IV

1.2, 1.4 16V, 1.4 FSI 1.4 TDI, 1.9 SDI, 1.9 TDI	(9N)	10.01 - 11.09		4A		OIL	200688	100688.0	600350	516004
	(9N)					GAS	210688	110688.0		
						OIL	211915	111915.0	600290	516010

POLO V

excl. 2.0 R WRC	(6R)	03.09 -				GAS	210689	110689.0	600270	516004
						GAS	211843	111843.0	600290	516010

POLO VI *NEW*

excl. 2.0	(AW, BZ1)	06.17 -				GAS	210689	110689.0	600270	516004
						GAS	211843	111843.0	600290	516010

SANTANA

	(32B)	08.81 - 12.84				OIL	200004	100004.0			516004
						GAS	210004	110004.0			
						GAS	211176	111176.0			

SCIROCCO

excl. 1.8 GT 16 V	(53, 53B)	02.74 - 07.92				OIL	200077	100077.0			
						GAS	210077	110077.0			
						OIL	201173	101173.0			
						GAS	211173	111173.0			
excl. , 2.0 R	(137, 138)	09.08 - 11.17		5A		GAS	210776	110776.0	600430		516007
						GAS	210127	110127.0			516004
						GAS	211916	111916.0			516010
incl. , 2.0 R	(137, 138)	09.08 - 11.17		5A		GAS	210777	110777.0	600430		516007
						GAS	210128	110128.0			516004
						GAS	211260	111260.0			516010

SHARAN

	(7M8, 7M9, 7M6)	02.95 - 03.10				GAS	210314	110314.0	600800	516004
						GAS	211429	111429.0		

VOLKSWAGEN (D)

	(7N1, 7N2)	05.10 -				GAS	210776	110776.0	600430	516007
						GAS	211916	111916.0		516010

T-CROSS *NEW*

	(C11)	12.18 -				GAS	212240	112240.0		
						GAS	212241	112241.0		

TARO

		04.89 - 03.97				GAS	211879	111879.0		
						GAS	211625	111625.0		-
	4x4 excl. Extra Cabin	04.89 - 03.97				GAS	211882	111882.0		
						GAS	211883	111883.0		-
	4x4 Extra Cabin	04.89 - 03.97				GAS	211884	111884.0		
						GAS	211883	111883.0		-

TIGUAN

	excl.	(5N)	09.07 - 07.18				GAS	210782	110782.0	600430	516007
							GAS	211922	111922.0		516010

TIGUAN II

	N.D. excl.	(AD1)	01.16 -				GAS	210785	110785.0		516006
							GAS	211925	111925.0		516010
	H.D. excl.	(AD1)	01.16 -				GAS	210785	110785.0		516006
							GAS	212217	112217.0		516001

TOURAN I

	excl.	(1T)	02.03 - 05.10				GAS	210776	110776.0	600430	516007
							GAS	211916	111916.0		516010

TOURAN II

		(1T3)	05.10 - 05.15				GAS	210776	110776.0	600430	516007
							GAS	211916	111916.0		516010

TOURAN III

	assale multilink	(5T1)	05.15 -				GAS	210785	110785.0		516007
							GAS	211925	111925.0		516010

TYPE I (MAGGIOLINO / BEETLE / COCINELLE / KÄFER / KEVER)





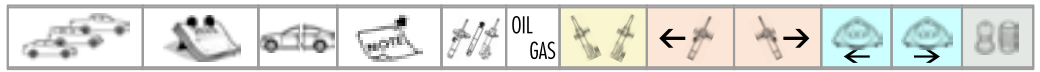

1200, 1200 Mexico, 1300, 1500		08.65 - 12.79				OIL	201901	101901.0		
						GAS	211902	111902.0		-
1302, 1303		01.70 - 07.73				OIL	200081	100081.0		
						GAS	211902	111902.0		-
1303		08.73 - 12.79				GAS	210082	110082.0		
						GAS	211902	111902.0		-

TYPE II TRANSPORTER



		01.55 - 07.67				GAS	211902	111902.0		
						GAS	211902	111902.0		-
		08.67 - 07.69				OIL	201905	101905.0		
						OIL	201905	101905.0		-









VOLKSWAGEN (D)

		08.69 - 12.79			%	OIL	201906	101906.0			-
						%	OIL	201905	101905.0		
 excl. Syncro 4X4		01.80 - 12.90			%	OIL	201907	101907.0			
						%	OIL	201908	101908.0		



TYPE III 1500 / 1600

 1500, 1600	(31)	04.61 - 03.75			%	GAS	211902	111902.0			-
						%	GAS	211902	111902.0		



TYPE IV / CARAVELLE / TRANSPORTER

		09.90 - 12.93			%	OIL	201912	101912.0			
						%	OIL	201909	101909.0		
		01.94 - 06.03			%	OIL	201912	101912.0			
						%	OIL	201909	101909.0		

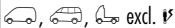

TYPE V / TRANSPORTER

		04.03 - 08.15		excl. H.D.	%	GAS	210781	110781.0			516007
						%	GAS	211919	111919.0		







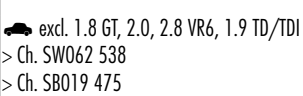

TYPE VI / TRANSPORTER

 excl. V	(SG_SF_)	04.15 -			%	GAS	210781	110781.0			516007
						%	GAS	211919	111919.0		

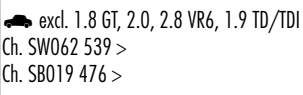
UP

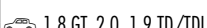
		12.11 -			%	GAS	210783	110783.0	600270		516004
						%	GAS	211923	111923.0		

VENTO

 excl. 1.8 GT, 2.0, 2.8 VR6, 1.9 TD/TDI > Ch. SW062 538 > Ch. SBO19 475	(1H2)	11.91 - 08.94		40A	%	OIL	200768	100768.0	600040	516004	
						GAS	210768	110768.0			
						%	OIL	201174	101174.0	600700	516010
							GAS	211174	111174.0		
 excl. 1.8 GT, 2.0, 2.8 VR6, 1.9 TD/TDI Ch. SW062 539 > Ch. SBO19 476 >	(1H2)	09.94 - 09.98		40C	%	OIL	200771	100771.0	600050	516004	
						GAS	210771	110771.0			
						%	OIL	201174	101174.0	600700	516010
							GAS	211174	111174.0		
 1.8 GT, 2.0, 1.9 TD/TDI	(1H2)	01.92 - 09.98		40B	%	GAS	210769	110769.0	600040	516004	
							%	GAS	211175	111175.0	600700
 2.8 VR6	(1H2)	01.92 - 09.98		40B	%	GAS	210769	110769.0	600040	516004	



VOLVO (S)

140 / 160 SERIES

142, 144, 144 S 145 164		08.66 - 08.74 08.66 - 08.74 08.66 - 08.74			±	OIL	201928	101928.0			
					∞	OIL	201929	101929.0			-

240 / 260 SERIES

excl. Turbo	(P242, P244) (P262, P264, P265)	08.74 - 08.93		41	/	OIL	200083	100083.0			516004
				42	∞	OIL	201930	101930.0			-
2.1 Turbo 2.1 Turbo	(P242, P244) (P245)	08.80 - 08.93 08.80 - 08.93		41	/	OIL	200083	100083.0			516004
					∞	OIL	201930	101930.0			-

300 SERIES

343, 345 340, 360	(343, 345) (344)	02.76 - 12.82 08.82 - 07.91			/	OIL	200084	100084.0			516004
					+	OIL	201931	101931.0			

400 SERIES

440, 460, 480 1.7 Turbo 480 ES excl. B18E eng. > Ch. 520381	(445, 464)	08.87 - 12.96 04.86 - 12.96			↗	GAS	210786	110786.0			516004
					∞	GAS	211932	111932.0			-

740

> Ch. F0081680	(744, 745)	08.83 - 04.84			/	GAS	210085	110085.0			516004
				43	∞	GAS	211933	111933.0			-
Ch. F0081681 >	(744, 745)	05.84 - 08.92			/	GAS	210086	110086.0			516004
				43	∞	GAS	211933	111933.0			-

760

> Ch. F0081680	(704, 764, 765)	02.82 - 04.84			/	GAS	210085	110085.0			516004
				43 ←	∞	GAS	211933	111933.0			-
Ch. F0081681 >	(704, 764, 765)	05.84 - 08.87			/	GAS	210086	110086.0			516004
				43 ←	∞	GAS	211933	111933.0			-
	(704, 764)	09.87 - 07.92			/	GAS	210086	110086.0			516004
				Multilink ←							
Ch. F0081681 >	(704, 765)	05.84 - 07.92			/	GAS	210086	110086.0			516004
				43 ←	∞	GAS	211933	111933.0			-

780











		01.85 - 08.87			/	GAS	210086	110086.0			516004
				43 ←	∞	GAS	211933	111933.0			-
		09.87 - 07.90			/	GAS	210086	110086.0			516004
				Multilink ←							

850



















excl. 2.3 T5, > Ch. 1744999	(LS, LW)	06.91 - 12.96			↗	GAS	210790	110790.0			516004
				excl.	∞	GAS	211934	111934.0			
excl. 2.3 T5, Ch. 1745000 >	(LS, LW)	06.91 - 12.96			↗	GAS	210790	110790.0			516004
				excl.	∞	GAS	211934	111934.0			

VOLVO (S)





940

  excl. Turbo	(944, 945)	08.90 - 10.98			/	GAS	210086	110086.0			516004
				43 	∅	GAS	211933	111933.0			-
  Turbo	(944, 945)	08.90 - 10.98			/	GAS	210086	110086.0			516004
				43 							





960

 > Ch. YV1964...R.048299	(964)	08.90 - 09.94			/	GAS	210086	110086.0			516004
				Multilink 							
 Ch. YV1964...R.048300 >	(964)	09.94 - 12.96				GAS	210798	110798.0			516004
					∅	GAS	211935	111935.0			-
 > Ch. YV1965...R.018099	(965)	08.90 - 09.94			/	GAS	210086	110086.0			516004
				43 	∅	GAS	211933	111933.0			-
 Ch. YV1965...R.018100 >	(965)	09.94 - 12.96				GAS	210798	110798.0			516004
					∅	GAS	211937	111937.0			-

























































C30

		10.06 - 12.12				GAS	210799	110799.1	110799.2	600480	516004
					∅	GAS	211938	111938.0			516010





C70 II

	(542)	03.06 - 06.13				GAS	210799	110799.1	110799.2	600480	516004
					∅	GAS	211453	111453.0			516010

S40 / V40

 excl.  	(VS, VW)	05.95 - 05.99				GAS	210788	110788.1	110788.2		516004
				excl. 		GAS	211183	111183.0			516010
 excl. 	(VS, VW)	05.95 - 05.99				GAS	210789	110789.1	110789.2		516004
				excl. 		GAS	211184	111184.0			516010
 excl.  T4	(VS, VW)	06.99 - 04.00				GAS	210791	110791.1	110791.2		516004
				excl. 		GAS	211183	111183.0			516010
 excl. T4	(VS, VW)	06.99 - 04.00				GAS	210792	110792.1	110792.2		516004
				Nivomat							
  1.9 T4	(VS, VW)	05.97 - 07.00				GAS	210792	110792.1	110792.2		516004
				excl. 		GAS	211184	111184.0			516010
 excl. 2.0 T4 excl.  	(VS, VW)	04.00 - 12.03				GAS	210793	110793.1	110793.2		516004
				excl. 		GAS	211185	111185.0			516010
 excl.   2.0 T4	(VS, VW)	04.00 - 12.03				GAS	210794	110794.1	110794.2		516004
				Nivomat							516010
  2.0 T4	(VS, VW)	08.00 - 12.03				GAS	210794	110794.1	110794.2		516004
				excl. 		GAS	211186	111186.0			516010







S40 II / V50

 S40  V50 excl. 4X4	(544, 545)	01.04 - 12.12 04.04 - 12.12				GAS	210799	110799.1	110799.2	600480	516004
					∅	GAS	211938	111938.0			516010









VOLVO (S)



















S60

 excl. 4X4, 		11.00 - 04.10		excl. 		GAS	210795	110795.0			516004
						GAS	211936	111936.0			516010







S60 II

 excl. 	(134)	04.10 -				GAS	210801	110801.1	110801.2		516004
						GAS	211940	111940.0			516010







S70 / V70 / C70

 S70 excl. 2.3 T5  C70	(874) (872)	01.97 - 08.00				GAS	210790	110790.0			516004
						GAS	211934	111934.0			516010
 V70 excl. 2.3 T5	(875, 876)	01.97 - 02.00				GAS	210790	110790.0			516004
						GAS	211934	111934.0			516010
 V70 excl. 4X4,  , 	(285)	11.99 - 12.08				GAS	210795	110795.0			516004
						GAS	211936	111936.0			516010









S80

 excl. 	(184)	05.98 - 07.06				GAS	210795	110795.0			516004
						GAS	211936	111936.0			516010





S80 II

 excl. 	(124)	03.06 -				GAS	210801	110801.1	110801.2		516004
						GAS	211940	111940.0			516010







S90

   excl. 	(964)	01.97 - 05.98				GAS	210798	110798.0			516004
						GAS	211935	111935.0			-







V40

 T2 GTDi, T4 GTDi, T4 GTDi, T4, T5, D2, D3, D4	(525, 526)	03.12 -				GAS	210803	110803.1	110803.2		516004
						GAS	211941	111941.0			516010









V60

 excl.  , 	(155, 157)	04.10 -				GAS	210801	110801.1	110801.2		516004
						GAS	211940	111940.0			516010







V70 III

 excl. 4x4, excl.  , 	(135)	08.07 -				GAS	210801	110801.1	110801.2		516004
						GAS	211940	111940.0			516010

V90

   excl. 	(965)	01.97 - 12.98				GAS	210798	110798.0			516004
						GAS	211937	111937.0			-





XC60

 excl. 	(156)	05.08 -				GAS	210802	110802.1	110802.2		516004
											516010







VOLVO (S)





XC60 II *NEW*

 excl. †	(246)	03.17 -				GAS	212246	112246.0			
						GAS	212247	112247.0			516001





XC70

 excl. 4x4, excl. †	(295)	03.00 - 08.07									
											





XC70 II

 excl. 4x4, excl. †	(136)	08.07 -				GAS	210801	110801.1	110801.2		
											

XC90

 excl. 4x4, †	(275)	10.02 -				GAS	210800	110800.0			
				excl. ①		GAS	211939	111939.0			





XC90 II *NEW*

 excl. †	(256)	09.14 -				GAS	212200	112200.0			516003
				excl. ①		GAS	212201	112201.0			516003













ZASTAVA (YU)



10

		10.05 -				GAS	210141	110141.0	600130	
								GAS	211280	111280.0





100

101, 128, GTL 55, GTL 65		1970 - 1985				OIL	200243	100243.0		
								OIL	200244	100244.0
125 P		1974 -				OIL	201378	101378.0		
										
102		1980 - 1989				OIL	200804	100804.0		
								OIL	200244	100244.0





1300 / 1500

1300, 1500, 125 PZ		1964 -				OIL	201378	101378.0		
										





YUGO 300 / 500

311, 511, 313, 513		1970 - 1985				OIL	200243	100243.0		
								OIL	200244	100244.0

YUGO 35 / 45 / 65

45, 55, 65, 65S		04.80 - 06.95				OIL	200804	100804.0		
								OIL	200244	100244.0

FLORIDA / MIAMI

		10.88 - 11.08				OIL	200256	100256.0	600570	
								OIL	201174	101174.0

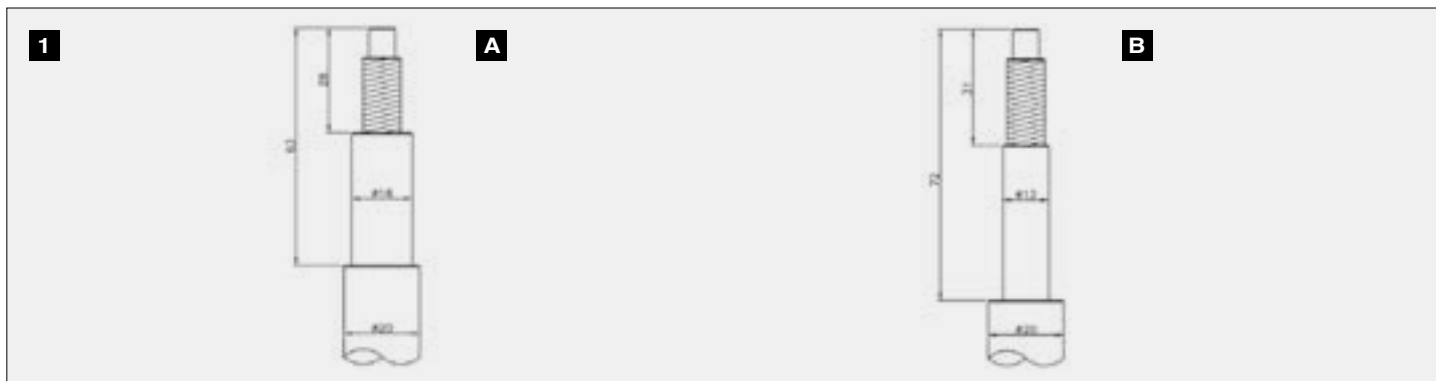

- 2** Ⓐ Il cuscinetto a rulli originale deve essere sostituito con un cuscinetto a sfere rif. 142040.
 Ⓑ The original needle-bearing has to be replaced by bearing Nr. 142040.
 Ⓒ Le roulement à aiguilles d'origine doit être remplacé par un roulement à billes réf. 142040.
 Ⓓ Beim Einsatz von Federbeinen, muß das vorhandene Naddellager am Federbein durch ein Kugellager Nr. 142040 ersetzt werden.
 Ⓔ El rodamiento de agujas debe sustituirse por el rodamiento nº 142040.
 Ⓕ O rolamento de agulhas original tem que ser substituído por um rolamento ref. 142040.

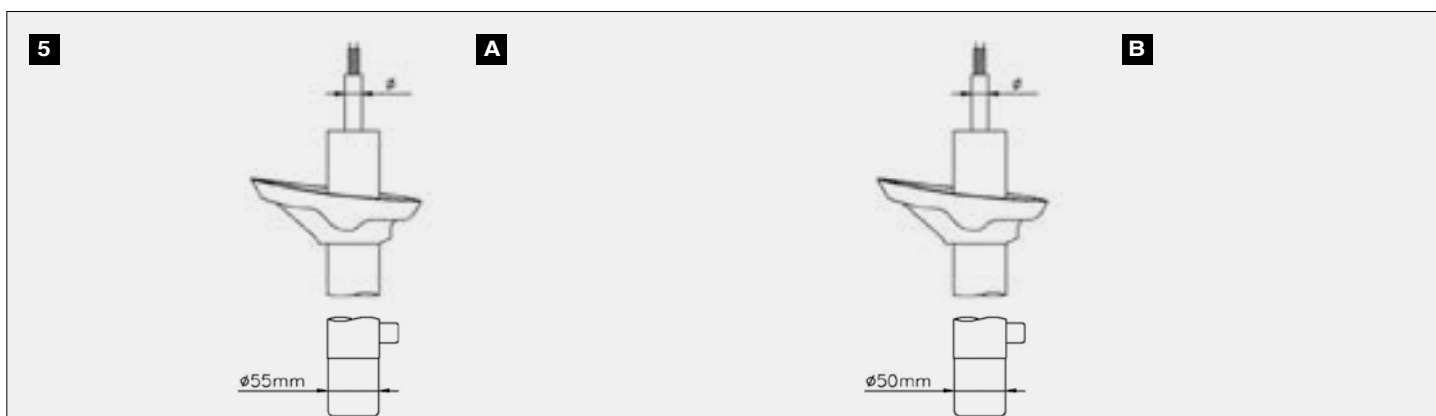
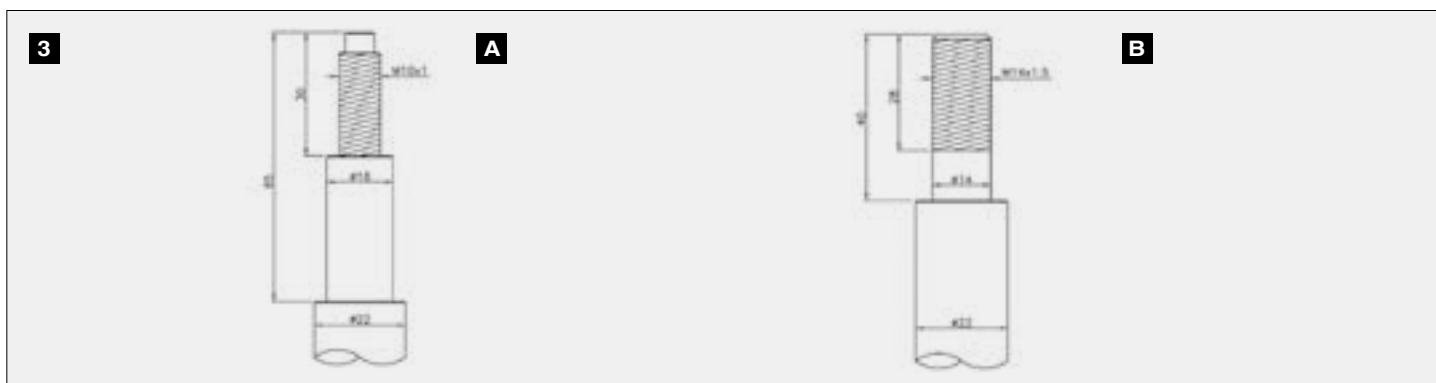

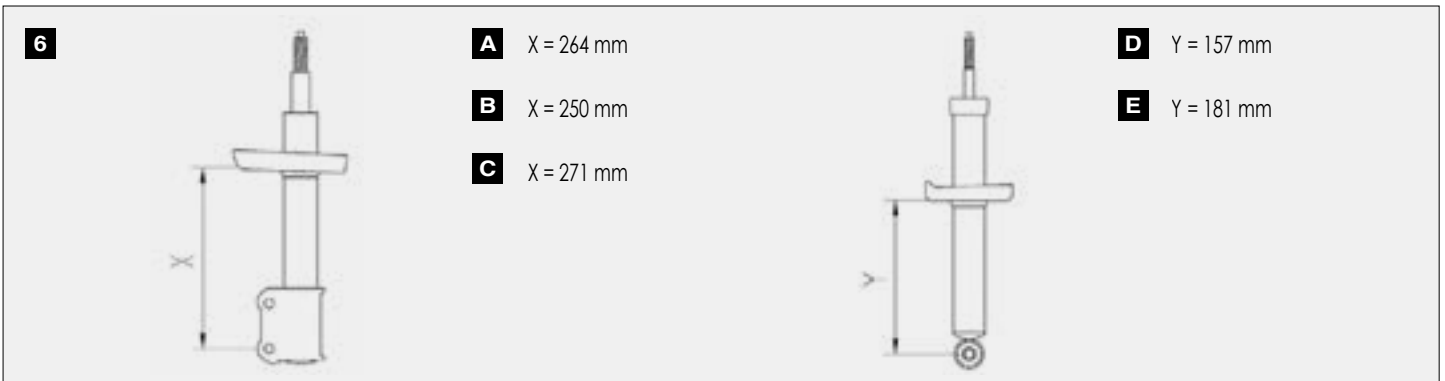

- | | |
|--|--|
| <p>7 A</p> <ul style="list-style-type: none"> Ⓘ Installare su montante Mac-Pherson di diametro esterno 45 mm. Ⓖ Fits vehicles with outside strut diameter of 45 mm. Ⓕ Pour une jamb dont le diamètre extérieur est de 45 mm. Ⓓ Bei einem äusseren federbeindurchmesser von 45 mm. verwenden. Ⓔ Para vehículos con diámetro exterior de columna de 45 mm. Ⓟ Para uma escora cujo diâmetro exterior é de 45 mm. | <p>B</p> <ul style="list-style-type: none"> Ⓘ Installare su montante Mac-Pherson di diametro esterno 51 mm. Ⓖ Fits vehicles with outside strut diameter of 51 mm. Ⓕ Pour une jamb dont le diamètre extérieur est de 51 mm. Ⓓ Bei einem äusseren federbeindurchmesser von 51 mm. verwenden. Ⓔ Para vehículos con diámetro exterior de columna de 51 mm. Ⓟ Para uma escora cujo diâmetro exterior é de 51 mm. |
|--|--|

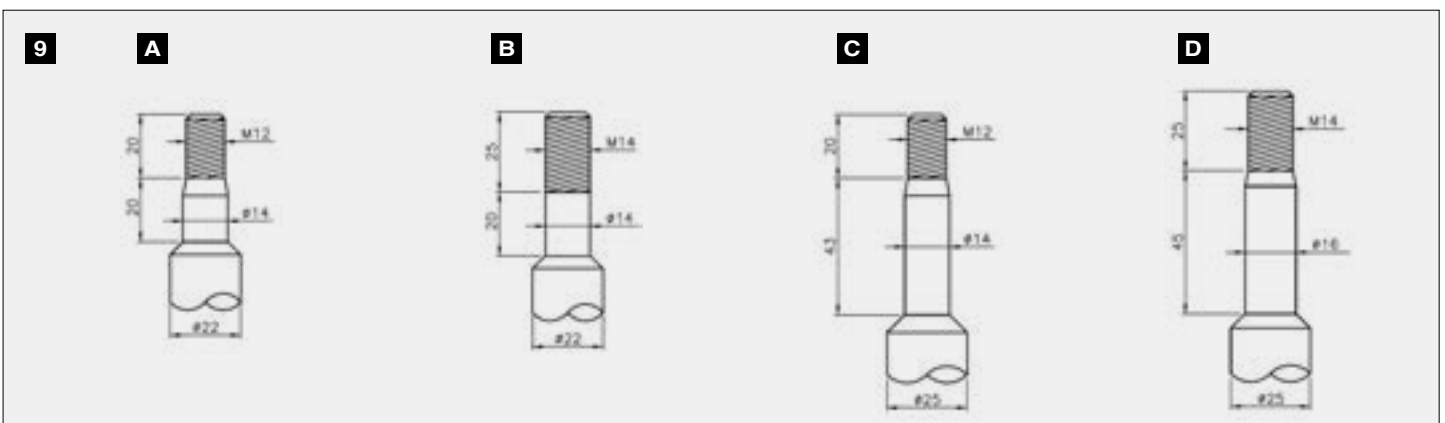
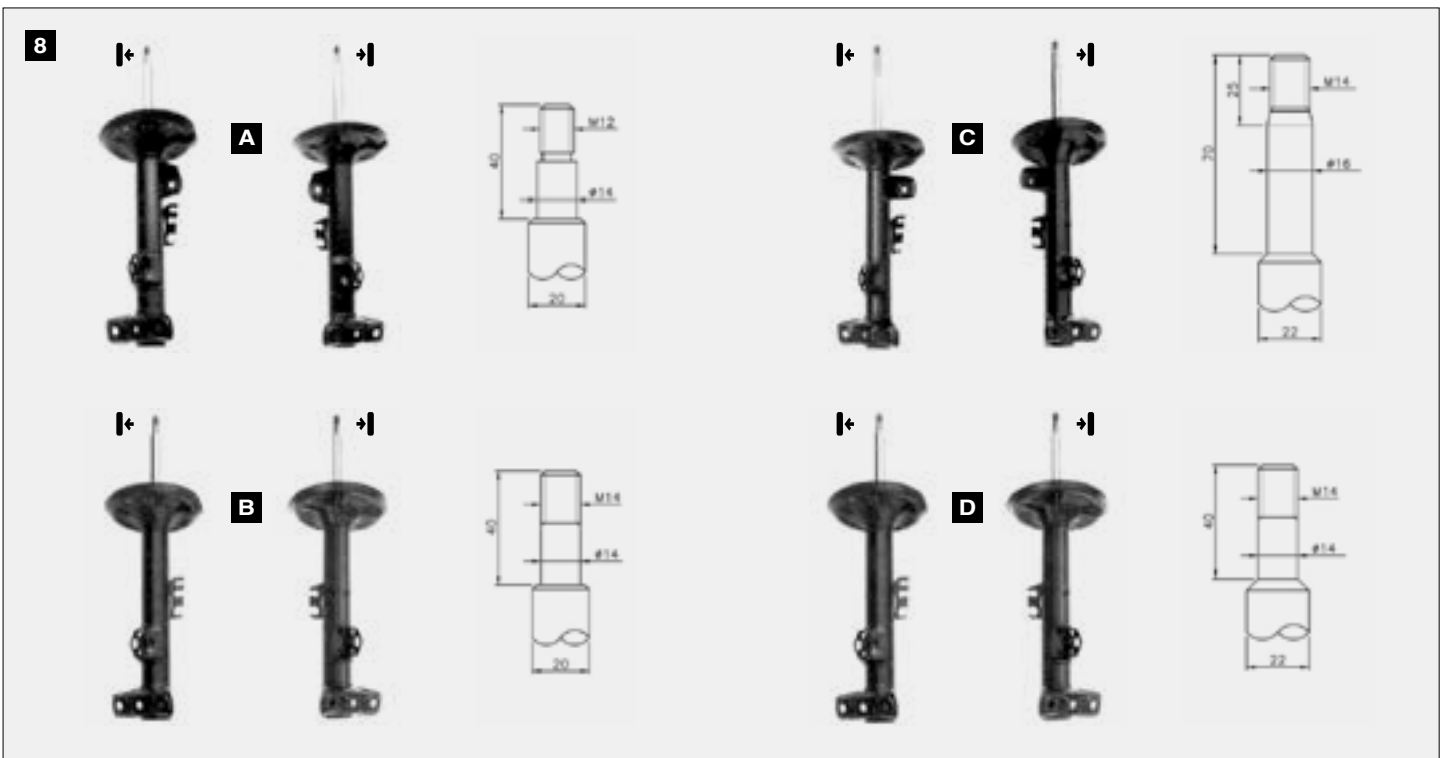

10

A A = 65 mm
B A = 82 mm

11

A A = 51 mm
B A = 47 mm

VERIFICARE DIAMETRO MOZZO ORIGINALE CHECK THE ORIGINAL HUB DIAMETER

12

<p>A</p> <p>Aperto - Extended 615 mm Chiuso - Collapsed 455 mm 25 mm</p>	<p>D</p> <p>Aperto - Extended 635 mm Chiuso - Collapsed 465 mm 15 mm</p>
<p>B</p> <p>Aperto - Extended 655 mm Chiuso - Collapsed 490 mm 35 mm</p>	<p>E</p> <p>Aperto - Extended 655 mm Chiuso - Collapsed 485 mm 15 mm</p>
<p>C</p> <p>Aperto - Extended 650 mm Chiuso - Collapsed 480 mm 20 mm</p>	<p>F</p> <p>Aperto - Extended 500 mm Chiuso - Collapsed 400 mm 60 mm</p>

13

A A = 58 mm
 B = 25 mm
B A = 72 mm
 B = 35 mm

14

A	B	C	D	E	F	G
A = 10 mm.	A = 16 mm.	A = 10 mm.	A = 16 mm.	A = 16 mm.	A = 16 mm.	A = 16 mm.
B = 16 mm.	B = 10 mm.	B = 16 mm.	B = 16 mm.	B = 16 mm.	B = 16 mm.	B = 16 mm.
La = 570 mm.	La = 535 mm.	La = 590 mm.	La = 490 mm.	La = 470 mm.	La = 465 mm.	La = 455 mm.
Lc = 360 mm.	Lc = 342 mm.	Lc = 367 mm.	Lc = 320 mm.	Lc = 300 mm.	Lc = 300 mm.	Lc = 315 mm.

15

OE REINFORCED

- 16**
- Ⓐ Ammortizzatore allungato da installare esclusivamente con la molla di carico 10883 o 10884
 - Ⓑ Extended shock absorber to install exclusively with auxiliary spring 10883 or 10884
 - Ⓒ Amortisseur allongé de installer avec ressort compensateurs 10883 ou 10884
 - Ⓓ Verlängererstoßdämpfer installations ausschließlich mit nivellierungsfedersätze 10883 oder 10884
 - Ⓔ Amortiguadore prolongado da instalar con la muella compesadora 10883 o 10884
 - Ⓕ Amortecedor alongado para instalar com mola de carga 10883 ou 10884

17

18

A	B	C	D
A = 12 mm.	A = 12 mm.	A = 12 mm.	A = 12 mm.
B = 12 mm.	B = 12 mm.	B = 14 mm.	B = 14 mm.
La = 380 mm.	La = 400 mm.	La = 395 mm.	La = 395 mm.
Lc = 270 mm.	Lc = 283 mm.	Lc = 280 mm.	Lc = 280 mm.

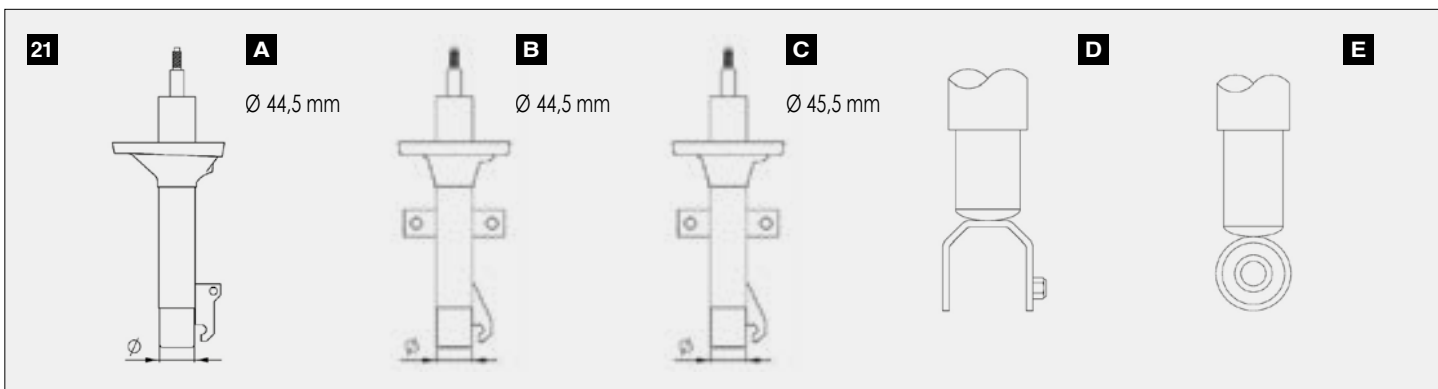
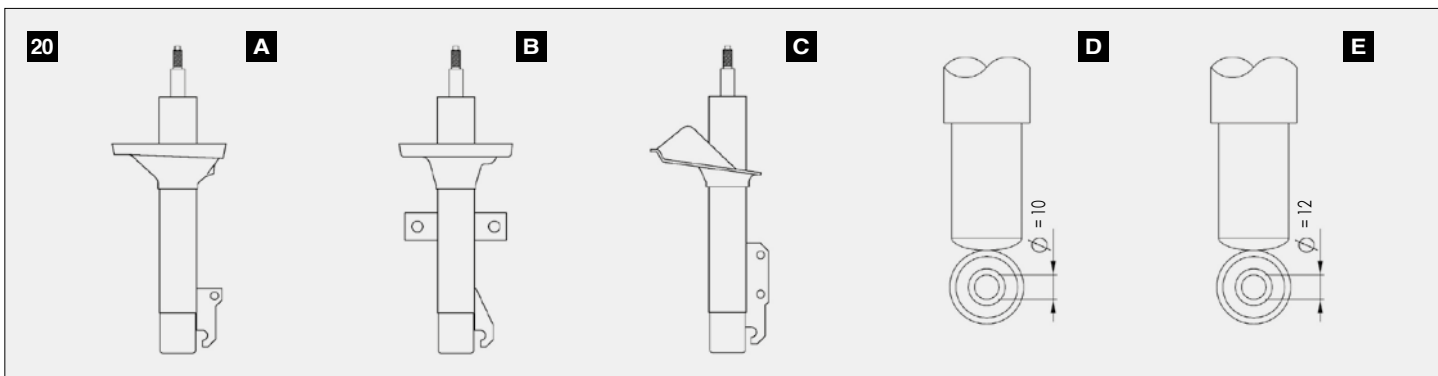

- 22**
- | | | | |
|----------|--------------------------------|----------|------------------------------|
| A | Ⓛ Piattello base molla rotondo | B | Ⓛ Piattello base molla ovale |
| | Ⓞ Round spring seat | | Ⓞ Oval spring seat |
| | ⓕ Plat de ressort rond | | ⓕ Plat de ressort oval |
| | ⓓ Rund Plattfeder | | ⓓ Oval Plattfeder |
| | ⓔ Plato de muella redondo | | ⓔ Plato de muella oval |
| | Ⓟ Assento de mola redondo | | Ⓟ Assento de mola oval |

23

A	B	C	D	E	F
A = 14 mm.	A = 14 mm.	A = 14 mm.	A = 14 mm.	A = 14 mm.	A = 14 mm.
B = 12 mm.	B = 12 mm.	B = 12 mm.	B = 12 mm.	B = 12 mm.	B = 12 mm.
La = 505 mm.	La = 550 mm.	La = 610 mm.	La = 480 mm.	La = 580 mm.	La = 635 mm.
Lc = 325 mm.	Lc = 350 mm.	Lc = 370 mm.	Lc = 305 mm.	Lc = 355 mm.	Lc = 585 mm.

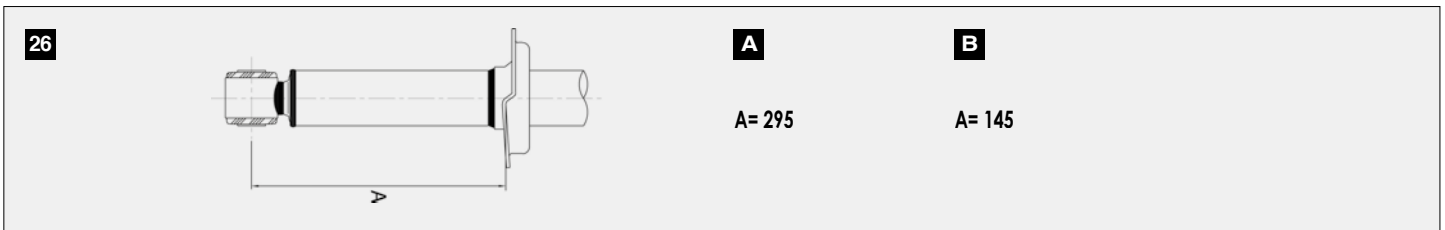
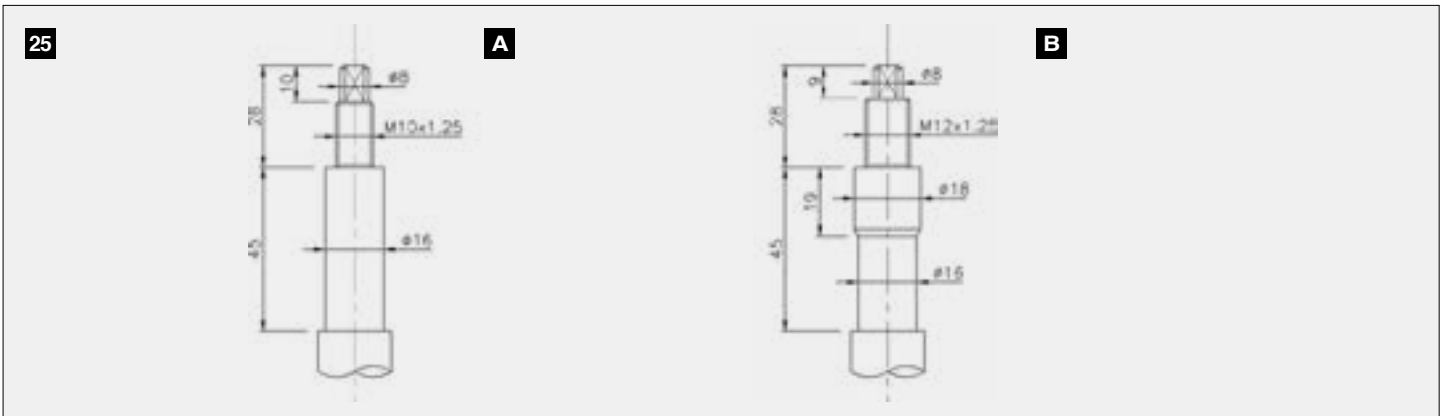

27

	A	B	C	D	E	F
A =	16 mm.	12 mm.	16 mm.	16 mm.	16 mm.	16 mm.
B =	16 mm.	12 mm.	16 mm.	16 mm.	16 mm.	16 mm.
La =	504 mm.	576 mm.	416 mm.	442 mm.	587 mm.	428 mm.
Lc =	312 mm.	352 mm.	266 mm.	280 mm.	355 mm.	280 mm.

- 28**
- Ⓘ 4 Ammortizzatori posteriori
 - ⒼⒷ 4 Rear shock absorbers
 - Ⓕ 4 Ammortisseurs postérieur
 - Ⓓ 4 Hintere Stoßdämpfer
 - Ⓔ 4 Amortiguadores trasero
 - Ⓖ 4 Amortecedores traseira

29



A
A = 46 mm

B
A = 40 mm

30



A
A = 12 mm.
B = 12 mm.
La = 588 mm.
Lc = 350 mm.

B
A = 14 mm.
B = 12 mm.
La = 485 mm.
Lc = 300 mm.

C
A = 14 mm.
B = 14 mm.
La = 588 mm.
Lc = 350 mm.

D
A = 14 mm.
B = 14 mm.
La = 626 mm.
Lc = 370 mm.

31

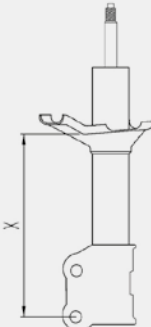

A
X = 215 mm.
X = 244 mm.

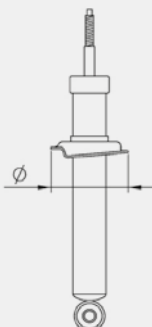

B
ø = 93 mm.
ø = 103 mm.

32

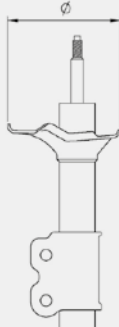

A
ø = 152 mm.

B
ø = 170 mm.

33



A
A = 10 mm.

B
A = 15 mm.

- | | |
|--|---|
| <p>34 A ① Ammortizzatore senza fissaggio della barra stabilizzatrice.
 ② Shock without drop link bracket.
 ③ Amortisseur sans fixation de la barre stabilisatrice.
 ④ Stoßdämpfer ohne Stabilisierungsstangenhalterung.
 ⑤ Amortiguador sin fijación de barra estabilizadora.
 ⑥ Amortecedor sem fixação de barra estabilizadora.</p> | <p>B ① Ammortizzatore con fissaggio della barra stabilizzatrice.
 ② Shock with drop link bracket.
 ③ Amortisseur avec fixation de la barre stabilisatrice.
 ④ Stoßdämpfer mit Stabilisierungsstangenhalterung.
 ⑤ Amortiguador con fijación de barra estabilizadora.
 ⑥ Amortecedor com fixação de barra estabilizadora.</p> |
|--|---|

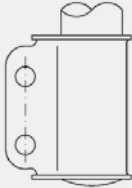
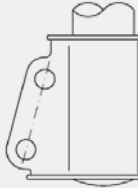
<p>35</p>  <p>A O.E.: 77 00 732 743 77 00 732 744 77 00 807 874 77 02 145 522 77 02 145 523</p>	<p>B</p>  <p>B O.E.: 77 00 786 597 77 00 807 873 77 02 150 468</p>
--	--

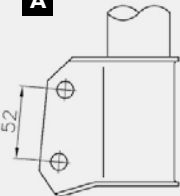
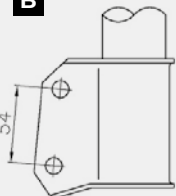
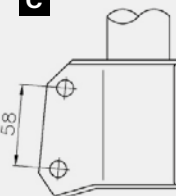
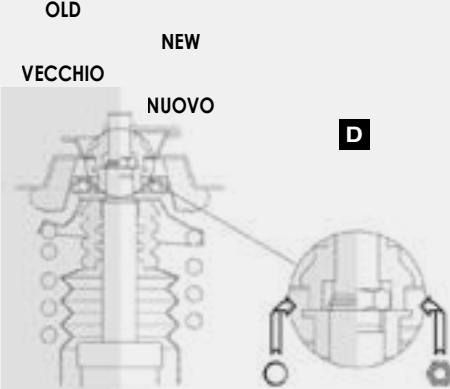
<p>36 A</p>  <p>O.E.: 77 00 808 490 77 00 816 045 77 00 823 130 77 00 828 680 77 00 838 084</p>	<p>B</p>  <p>O.E.: 77 00 808 491 / 77 00 808 492 77 00 816 046 / 77 00 823 129 77 00 823 131 / 77 00 828 681 77 00 828 682 / 77 00 828 683 77 00 828 684 / 77 00 838 083 77 00 838 085 / 77 00 838 086 77 00 838 087 / 77 00 838 088</p>	<p>C</p>  <p>O.E.: 77 00 423 726 77 00 423 727 77 00 423 729</p>	<p>D</p>  <p>OLD NEW VECCHIO NUOVO</p>
---	--	--	---

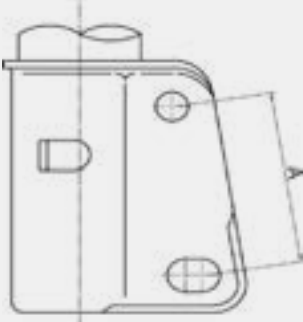
<p>37</p> 	<p>A A = 60 mm Body Ø47</p> <p>B A = 75 mm Body Ø52</p>
--	---

<p>38 A</p>  <p>34 mm.</p>	<p>B</p>  <p>24 mm.</p>
--	---

39

- Ⓘ Sospensione anteriore senza barra di torsione.
- Ⓖ Front suspension without torsion bar.
- Ⓕ Train avant sans barre de torsion.

- Ⓓ Vorderaufhängung ohne Torsionsstab.
- Ⓔ Suspensión delantera sin barra de torsión.
- Ⓖ Suspensão dianteira sem barra estabilizadora.

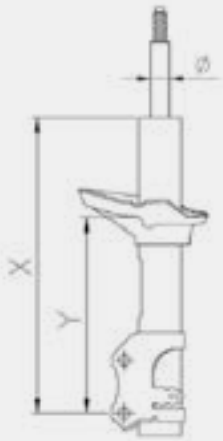
40

- A** X = 320 mm Y = 228 mm Ø = 20 mm
- B** X = 342 mm Y = 228 mm Ø = 22 mm
- C** X = 336 mm Y = 228 mm Ø = 20 mm
- D** X = 318 mm Y = 228 mm Ø = 22 mm
- E** X = 336 mm Y = 228 mm Ø = 22 mm
- F** X = 340 mm Y = 250 mm Ø = 22 mm

41

- Ⓘ Se le cartucce originali sono a gas, montare l'adattatore Volvo rif. 122 94 23 sotto la cartuccia.
- Ⓖ If the original insert are gas pressurized, place Volvo spacer n° 122 94 23 underneath the insert.
- Ⓕ Si les cartouches d'origine sont à gaz, montez l'adaptateur Volvo Réf. 122 94 23 sous la cartouche.
- Ⓓ Wenn Original-Gasdruckeinsätze montiert sind, Volvo Adapter Nr. 122 94 23 im Federbein unter den Federbeineinsatz montieren.
- Ⓔ Si los cartuchos originales son de gas presurizado, coloque el adaptador Volvo N° 122 94 23 debajo del cartucho.
- Ⓖ Se as aplicações de origem forem a gás, monte o adaptador Volvo ref. 122 94 23 por baixo da aplicação.

42

- Ⓘ Se il veicolo è munito di correttore d'assetto, sostituire la molla con una Volvo rif. 122 90 52/3/4.
- Ⓖ If the vehicle is equipped with a self levelling suspension, replace the spring by a Volvo one N° 122 90 52/3/4.
- Ⓕ Si le véhicule est équipé d'un correcteur d'assiette, remplacez le ressort par un Volvo Réf 122 90 52/3/4.
- Ⓓ Wenn das Fahrzeug mit automatischem Niveau-Ausgleich-System versehen ist, Originalfeder durch Volvo Feder Nr. 122 90 52/3/4 ersetzen.
- Ⓔ Si el vehículo está equipado con suspensión autonivelada, sustituya el muelle por un muelle Volvo N° 122 90 52/3/4.
- Ⓖ Se o veículo estiver equipado com uma suspensão autonivelável, substitua a mola por uma Volvo ref. 122 90 52/3/4.

43

- Ⓘ Se il veicolo è munito di correttore d'assetto, sostituire la molla con una Volvo rif. 135 97 10 o 127 39 77.
- Ⓖ If the vehicle is equipped with a self levelling suspension, replace the spring by a Volvo one N° 135 97 10 or 127 39 77.
- Ⓕ Si le véhicule est équipé d'un correcteur d'assiette, remplacez le ressort par un Volvo Réf 135 97 10 ou 127 39 77.
- Ⓓ Wenn das Fahrzeug mit automatischem Niveau-Ausgleich-System versehen ist, Originalfeder durch Volvo Feder Nr. 135 97 10 oder 127 39 77 ersetzen.
- Ⓔ Si el vehículo está equipado con suspensión autonivelada, sustituya el muelle por un muelle Volvo N° 135 97 10 ó 127 39 77.
- Ⓖ Se o veículo estiver equipado com uma suspensão autonivelável, substitua a mola por uma Volvo ref. 135 97 10 ou 127 39 77.

ORDINI: Gli ordini devono pervenire presso la nostra sede a mezzo fax o posta elettronica. Solo in via del tutto eccezionale possono essere accettati ordini verbali, in tal caso si declina ogni responsabilità per inesattezze, incomprensioni o interpretazioni errate. Tutti gli ordini sono subordinati all'approvazione da parte dell'azienda che si riserva la facoltà di accettarli.

PREZZI: Per tutti gli ammortizzatori a catalogo fanno fede i prezzi indicati sul listino in vigore. Tutti i prezzi si intendono IVA esclusa e franco nostro stabilimento. L'azienda si riserva la facoltà di modificare i prezzi convenuti senza obbligo di preavviso. Invitiamo la gentile clientela a verificare tutte le condizioni indicate nella conferma d'ordine.

CONSEGNE: Tutti i termini di consegna del materiale ordinato, anche se indicati nella conferma d'ordine, sono da considerarsi indicativi e non impegnativi per l'azienda. I ritardi o le mancate consegne del materiale eventualmente non disponibile presso i nostri magazzini non potranno dare consenso all'annullamento dell'ordine in corso, né potranno costituire pretesto per risarcimento di danni. Eventuali deroghe alle presenti condizioni di consegna devono essere concordate ed accettate per iscritto da entrambe le parti.

CONFEZIONAMENTO: Tutto il materiale verrà consegnato adeguatamente confezionato, secondo gli standard previsti dall'azienda. Eventuali variazioni in questo senso devono essere concordate con l'ufficio commerciale e regolamentate per iscritto. Le spese di confezionamento si intendono comprese nel prezzo degli ammortizzatori.

IMBALLO: L'imballo verrà effettuato secondo gli standard in uso e fatturato al costo. Eventuali variazioni in tal senso devono essere preventivamente concordate per iscritto da entrambe le parti.

SPEDIZIONE: La merce viaggia sempre a rischio e pericolo del committente, anche se spedita in porto franco. In mancanza di precise indicazioni del committente tutto il materiale verrà spedito con il mezzo ritenuto più opportuno. La nostra responsabilità, per tutto il materiale spedito, si conclude alla consegna del medesimo al vettore. Eventuali danni, furti, manomissioni o quant'altro possa arrecare inconvenienti al committente vanno gestiti direttamente dallo stesso con il trasportatore. Il destinatario rimane comunque vincolato al pagamento totale della merce spedita. L'azienda non risponde per eventuali ritardi nelle consegne derivanti da cause di forza maggiore o da circostanze dipendenti dal vettore.

RECLAMI: Eventuali reclami, dovuti a discordanze riscontrate nella documentazione, o di qualsiasi altra natura, devono essere notificati entro e non oltre 8 giorni dalla data di ricevimento del materiale a mezzo lettera raccomandata. Fanno eccezione tutti i reclami considerati motivo di garanzia per i quali rimandiamo alla sezione "garanzia del prodotto".

PAGAMENTI: Il pagamento delle fatture deve essere fatto entro il termine prescritto ed indicato in fattura. Il mancato rispetto dei termini di pagamento comporterà l'addebito delle spese di insoluto e degli interessi di mora, calcolati in base al tasso EURIBOR maggiorato di 6 punti; renderà inoltre le altre fatture in corso, ancorché non scadute, immediatamente esigibili. Il mancato pagamento autorizza pure l'azienda a sospendere tutte le forniture con effetto immediato. I pagamenti sono validi solo se effettuati, direttamente all'azienda o a persona da noi espressamente autorizzata, secondo le disposizioni concordate con il nostro ufficio amministrativo.

CONTROVERSIE: Per qualsiasi controversia, nessuna esclusa, sarà competente il Foro di Treviso.

TUTELA DELLA PRIVACY: Tutti i dati relativi al committente, ivi compresi quelli inerenti gli ordinativi e le condizioni in uso, saranno custoditi ed elaborati, anche con sistemi informatici, per soli scopi statistici, adempimenti fiscali e di legge e per l'invio di materiale informativo o promozionale, secondo quanto stabilito dalla legge 675/96 e D.L.196/2003 in materia.

Tutte le condizioni riportate, ivi incluse quelle seguenti, relative alla garanzia del prodotto, si ritengono accettate integralmente al momento del ricevimento dell'ordine, sia esso scritto o verbale.

GARANZIA DEL PRODOTTO

L'intera gamma **VITAL SUSPENSIONS** è offerta con una garanzia di due anni. Tale garanzia si ritiene subordinata alle condizioni, elencate di seguito, che l'acquirente è tenuto a verificare e rispettare durante l'intero periodo garantito.

CONDIZIONI DI GARANZIA: La garanzia di due anni applicata a tutti gli ammortizzatori copre esclusivamente le non conformità, verificate sugli ammortizzatori stessi, relativamente a vizi di fabbricazione e di funzionamento.

La garanzia del prodotto, in quanto tale, vale esclusivamente nei termini di sostituzione gratuita del materiale riconosciuto difettoso.

Tale garanzia inoltre si ritiene valida per il solo prodotto riconosciuto non conforme, pertanto non prevede estensioni a coppie o insiemi di ammortizzatori, anche se installati sul medesimo veicolo.

Non sussistono risarcimenti, o pretese di qualsiasi natura, ulteriori a quelle precedentemente esposte; anche qualora direttamente o indirettamente collegate alla non conformità del prodotto.

La garanzia non comprende :

- La normale usura dell'ammortizzatore.
- I danni derivanti da incidenti, di qualsivoglia natura, subiti dal veicolo.
- I danni provocati all'ammortizzatore da un montaggio scorretto o dall'impiego di attrezzature non idonee (es. stelo rovinato dalle pinze).
- I danni provocati dall'utilizzo dell'ammortizzatore su veicoli diversi da quelli per i quali è stato realizzato, in conformità a quanto riportato sullo stesso catalogo corrente.
- I danni causati da manomissioni di qualsiasi natura apportate all'ammortizzatore.
- Le non conformità dovute all'impiego dell'ammortizzatore su sistemi di sospensione speciali per i quali non è previsto il suo impiego (sospensioni autolivellanti, sospensioni regolabili elettronicamente, ecc.).
- I danni arrecati all'ammortizzatore dall'utilizzo del veicolo in competizioni automobilistiche di qualsiasi natura.
- I danni causati all'ammortizzatore dal montaggio su sospensioni con caratteristiche e componenti diversi dall'originale, quali ad esempio molle tagliate, tamponi e parapolvere modificati o eliminati, ecc.
- Eventuali montaggi abbinati a molle di assetto sportivo, eccezion fatta per le molle di assetto di nostra produzione e per i pacchetti sportivi forniti dalla casa produttrice.
- I danni arrecati da manutenzione scorretta o insufficiente del mezzo.

RICHIESTA DI GARANZIA: La richiesta di garanzia del prodotto deve essere presentata al concessionario presso il quale è stato acquistato.

Il concessionario stesso provvederà direttamente, dopo l'accertamento della non conformità, alla sostituzione del materiale difettoso.

Al concessionario dovranno essere consegnati tutti i dati indispensabili alla verifica della garanzia, e più precisamente :

- Estremi dell'acquirente o dell'officina di montaggio.
- Codice dell'articolo non conforme.
- Quantità non conforme.
- Data di acquisto e di montaggio.
- Dati di riconoscimento del veicolo.
- Condizione del veicolo al momento del montaggio.
- Descrizione dettagliata della non conformità.

Il concessionario successivamente avrà cura di trasmettere i suddetti dati all'ufficio di Controllo Qualità del produttore il quale avvierà il processo di verifica.

Dopo l'acquisizione dei dati forniti dal cliente verrà data l'autorizzazione al reso del materiale difettoso.

Il prodotto ritenuto non conforme dovrà quindi pervenire presso di noi, in porto franco, corredato di documento in conto garanzia (qualora il materiale non fosse spedito dal distributore la bolla dovrà recare come intestatario il distributore stesso).

Sarà respinto tutto il materiale spedito senza il benestare a procedere da parte dell'azienda.

Il ripristino, la sostituzione o l'accredito del prodotto in garanzia sarà fatto solo dopo l'accertamento della non conformità da parte del personale tecnico addetto al controllo qualità, nel rispetto delle condizioni sopra elencate. Lo stesso personale sarà a disposizione del cliente per ogni chiarimento in merito.

La possibilità di sostituzione immediata del materiale ritenuto non conforme, al fine di evitare il fermo del veicolo, è prerogativa esclusiva del distributore, il quale può eventualmente adottarla a sua discrezione, rimanendo tuttavia non vincolata alle condizioni generali di garanzia del prodotto.

Per conoscenza segnaliamo che tutti i reclami ed i certificati di garanzia verranno archiviati, unitamente ai dati a nostra disposizione (cliente, non conformità, riferimenti produttivi, ecc.), per disporne in qualunque momento e per verificare l'utilità di azioni correttive eventualmente necessarie su alcuni prodotti.

Tutti i dati dei clienti verranno comunque custoditi ed elaborati esclusivamente per attività informatiche e di ricerca interne all'azienda, adempimenti di legge ed eventuale invio di materiale informativo-promozionale; in conformità a quanto richiesto dalla legge 675/96 e D.L.196/2003 sulla tutela della privacy.

PURCHASE ORDERS: Orders must be forwarded to our offices by fax or e-mail. Verbal orders will be accepted only in very special conditions, in which case we shall not be held responsible for inexactness, misunderstandings or erroneous interpretation.

Orders are subject to approval by our offices who reserves the right to accept them.

PRICES: For all shock absorbers in our catalogue the prices applied are those contained in the current up to date price-lists.

All prices do not include VAT and are for goods available ex works.

We reserve the right to make changes to the prices agreed without notice. We therefore invite customers to check all conditions at the time of our order confirmation.

DELIVERY: All delivery times provided for the goods that have been ordered, even when stated in our order confirmation, should be considered approximate and are not binding to the supplier.

Any delays or failure to deliver any goods not currently available in our warehouses shall not entitle cancellation of the order in progress and give grounds for an indemnification claim.

Any variation to these delivery terms shall be agreed and accepted in writing by both parties.

PACKAGING: All goods are delivered suitably packed, according to our company's standards.

Any variations shall be agreed with our sales department and made in writing.

The cost of packaging is included in the price of the shock absorber.

PACKING: Goods are packed by our company according to our standards and invoiced according to cost.

Any variations shall be agreed writing by both parties.

DELIVERY: Goods travel always at the customer's own risk, even when delivered duty paid.

Unless specifically stated by the customer, the goods will be delivered with the means of transport we consider most appropriate.

Our liability regarding all the goods dispatched ends upon their delivery to the forwarding agent.

Any damage, theft, tampering with or any other inconveniences caused to the customer shall be handled by the latter with the forwarding agent.

The consignee shall always pay the total amount of the goods delivered.

We shall not be held responsible for any delays due to circumstances beyond our control and/or natural calamities, or other circumstances depending on the forwarding agent.

COMPLAINTS: Any complaints due to discrepancies in the documents or of any other kind, shall be notified by registered letter no later than 8 days after receipt of the goods.

This clause does not apply in the case of complaints considered warranty conditions regarding this please see the "Product warranty" section.

PAYMENTS: Invoices shall be paid within the prescribed term stated in the invoice. Non-compliance with the terms of payment shall cause any unsettled payment expenses to be charged interest for delayed payment, calculated according to the EURIBOR rate plus 6% and due for immediate payment even if not overdue.

Any failure to settle payments authorises us to suspend all deliveries immediately.

Payments are valid only when made directly to our company or to any person authorised by the company in agreement with our administration.

DISPUTES: Disputes of any kind shall be submitted to the jurisdiction of the Court of Treviso.

PRIVACY: All data concerning customers, including any information concerning orders and terms applied, shall be stored and processed, even electronically solely for statistical purposes, for legal or fiscal requirements and for dispatching informative or promotional material as prescribed by the relevant Italian Law on Privacy.

PRODUCT WARRANTY

Our whole range of **VITAL SUSPENSIONS** is offered with a two-year warranty.

The warranty is subject to the conditions stated below that the purchaser must check and respect for the entire warranty period.

WARRANTY CONDITIONS: The two-year warranty is applied to shock absorbers in the "improved" range and covers exclusively non-compliance assessed on the shock absorbers due to manufacturing or working defects.

Our product warranty is applied exclusively in terms of free of charge replacement goods acknowledged as being faulty.

In addition, the warranty applies in the case of a single product acknowledged as non-confirming and therefore cannot be extended to pairs or multiple shock absorbers, even when they are installed on the same vehicle.

No compensation or claims of any kind besides those aforementioned are acceptable even when directly or indirectly related to the non-conforming component.

The warranty does not include:

- Normal wear and tear of shock absorbers
- Damage caused by accidents of any kind involving the vehicle.
- Damage caused to the shock absorber by improper installation or by the use of unsuitable equipment (e.g. piston rod ruined by pincers).
- Damage caused by using the shock absorber on a vehicle other than the model the shock absorber has been made for as mentioned in our current catalogue.
- Damage caused by any kind of tampering with the shock absorber.
- Non-compliance due to the use of the shock absorber in special suspension systems to which it is not suited (self-levelling suspensions, electronically adjustable suspension, etc.).
- Damage cause to the shock absorber by the use of the vehicle in any kind of car competitions.
- Damage caused to the shock absorber by installation on suspension using features and components differing from the original, such as cut springs, modified or eliminated rebound bumpers and dust covers, etc.
- Any installation combined with sports springs, apart from our own series and from original sports kits supplied by the manufacturer.
- Damage due to improper or insufficient maintenance of the vehicle.

WARRANTY REQUEST: The product warranty request must be forwarded to the dealer where it has been purchased.

After assessing non-compliance the dealer shall replace the faulty goods immediately.

It is necessary to provide the dealer with all the information needed to check the warranty, i.e.:

- Customer or installation shop details.
- Non-conforming article part number.
- Non-conforming quantity.
- Date of purchase and installation.
- Vehicle identification data.
- Vehicle conditions at the time of installation.
- Detailed description of non-compliance.

The dealer shall then communicate the information above to the manufacturer's Quality Control Service, which initiates the control process.

On receipt of the information provided by the customer the return of the faulty goods will be authorised.

Any products considered non-conforming shall therefore be returned to us carriage paid together with a warranty delivery note (if the goods are not returned via the distributor the delivery note shall be sent with the distributor as consignee).

Any goods returned without our approval shall be rejected.

The repair, replacement of our credit note for the product under warranty shall occur only once non-compliance has been assessed by our quality control technicians in the full respect of the above-mentioned conditions.

Our staff is at customer's disposal for any explanations regarding these matters.

The possibility of immediate replacement the goods considered non-conforming in prevent stopping the vehicle, depends exclusively on the distributor who proceed at his own discretion, remaining however not bound by the product general warranty conditions. We inform you that all complaints and warranty certificates will be filed together with the information available to us (customer, non-compliance, production references, etc.) so that we can use them at any time and to assess the utility of any corrective actions required for products.

All customer data will be filed and processed only for internal information and research activities, legal or fiscal requirements and dispatch of informative and promotional material in compliance with the Italian Law concerning the safeguard of privacy.

All the aforesaid conditions are considered accepted in full upon receipt of a written or verbal order.

PARAOLIO SCOPPIATO

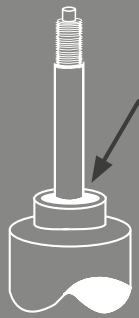

Ammortizzatore che presenta una slabbratura della guarnizione di tenuta con conseguente perdita di olio e quindi rottura dell'ammortizzatore, dovuta alla NON sostituzione del tampone di fine corsa deteriorato e quindi al non rispetto del suo corretto funzionamento come assorbitore d'urti.

A shock absorber with burring on the gasket and consequent oil leak, which would lead to the shock absorber breaking. This is caused by failure to replace the worn rubber rebound bumper, which is unable to absorb any impact.

SFONDAMENTO DI FINECORSA

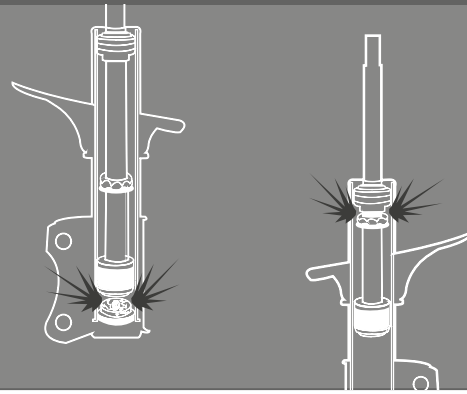

Sfondamento della valvola di fondo dell'ammortizzatore e del pistone a causa del continuo lavoro a fine corsa inferiore dell'ammortizzatore causato da percorrenza in strade dissestate e da continui dossi rompi velocità con conseguente deterioramento del tampone di fine corsa e del cedimento progressivo della molla di sospensione. Risultato perdita olio, effetto elastico e non funzionamento dell'ammortizzatore.

A smashed bottom valve and piston rod due to continued working of the shock absorber at the bottom, caused by uneven road surfaces or speed humps, which damage the rubber rebound bumper and gradually cause the suspension spring to give way. The result is leaking oil, reduced elastic effect and ineffective shock absorber.

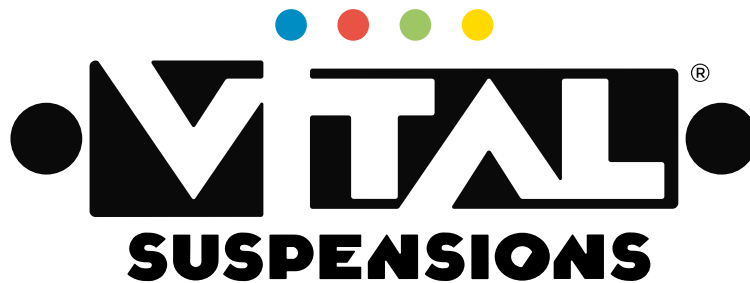

PRINCIPALI CAUSE DI DANNEGGIAMENTO NON IMPUTABILI A DIFETTOSITÀ DEL PRODOTTO

PRINCIPLE DEFECTS DUE TO IMPROPER HANDLING OF PRODCUT

ROTTURA TAMPONE DI FINECORSA

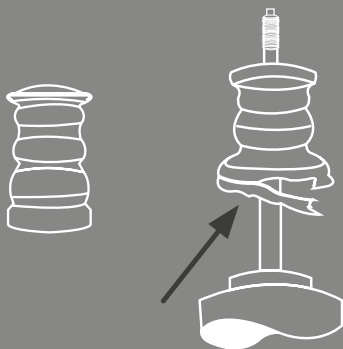

Ammortizzatore danneggiato per usura del tampone di fine corsa, dove soprattutto con il nuovo e massiccio impiego da parte dei costruttori del poliuretano microcellulare che evita in parte anche il sovraccarico del mezzo, il tampone si deteriora rapidamente sia come sfrangiatura che come rigidità con conseguente rottura dell'ammortizzatore per urti di fine corsa inferiore.

A shock absorber damaged by a worn rubber rebound bumper due to the massive use by manufacturers of microcell polyurethane to make the bumpers, which avoid part of the shock absorber overload. With excessive work the bumper deteriorates, disintegrates and becomes hard, and therefore the shock absorber breaks due to closing impact.

ROTTURA OCCHIELLI E PERNI

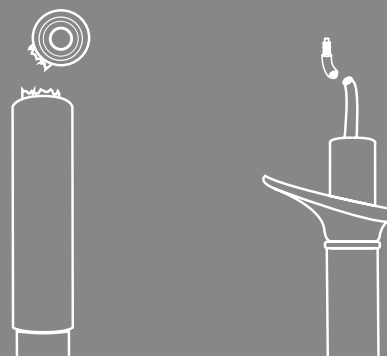

Ammortizzatore che presenta il distacco dell'occhiello (o del perno) dovuto ad un urto, o nel caso del perno, al non corretto montaggio con il giusto serraggio di coppia eseguito con le attrezzature non corrette, utilizzando la pistola pneumatica anziché la chiave dinamometrica. Il distacco dell'occhiello può avvenire anche nel caso in cui il fissaggio dell'ammortizzatore sia stato fatto ancora a veicolo sollevato, anziché con le ruote appoggiate al terreno e quindi con l'ammortizzatore nella corretta posizione di lavoro.

A shock absorber with a broken grommet (or pin), caused by a collision or incorrectly mounting the pin using the wrong tools (e.g. pneumatic screwdriver instead of a torque wrench). The grommet could also detach when the shock absorber has been mounted with the vehicle lifted off the ground and not with the wheels on the ground, which is the correct position to work the shock absorber.

PRINCIPALI CAUSE DI DANNEGGIAMENTO NON IMPUTABILI A DIFETTOSITÀ DEL PRODOTTO
PRINCIPLE DEFECTS DUE TO IMPROPER HANDLING OF PRODCUT

FILETTATURA ROVINATA



Ammortizzatore che presenta il filetto rovinato, in quanto nel montaggio non è stato utilizzato il KIT di viti corredato, bensì un dado di passo diverso da quello fornito, e soprattutto perché si è utilizzato la pistola pneumatica e non invece la chiave dinamometrica.

A shock absorber with ruined thread, due to being mounted without using the supplied screws, but just a nut with a different pitch to the one supplied. Using a pneumatic screwdriver instead of a torque wrench can also cause this damage.

AMMORTIZZATORE STORTO



Ammortizzatore che si presenta piegato, o solo con l'albero storto, oppure il corpo piegato; normalmente questo avviene nel caso dell'albero storto, quando il veicolo urta uno scalino nella strada, mentre la piegatura del corpo dell'ammortizzatore nel caso di incidente più o meno marcato.

A shock absorber with twisted bracket, body or pin. If the piston is twisted it is normally due to impact with a kerb, while a twisted body is caused by a more serious accident.

FORI ATTACCO MODIFICATI

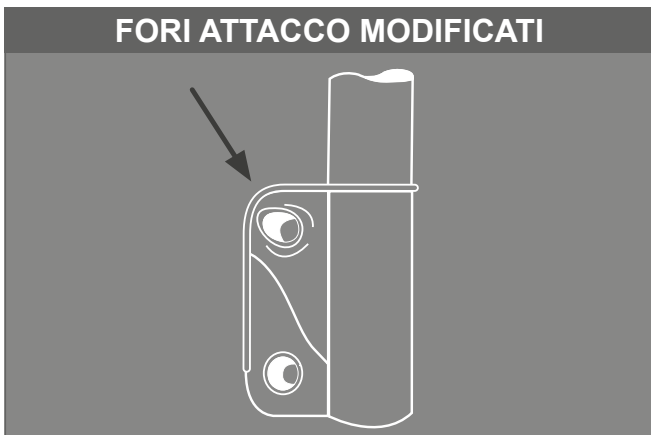

Ammortizzatore che presenta una allargatura manuale del foro di attacco al mozzo ruota in fase di controllo della geometria del veicolo, dovuto principalmente a fattori accidentali che il veicolo ha subito sulla strada, come incidenti e urti vari con conseguente spostamento degli assi di camber.

The shock absorber has a manual widening of the wheel hub attachment hole during alignment, which is caused by road accidents that cause the camber axle to move.

STELO ROVINATO E ARRUGGINITO



Superficie cromata dello stelo rovinata da ammaccature, botte e ruggine con conseguente perdita di olio attraverso il paraolio, difetto questo dovuto nella fase di montaggio dal non corretto fissaggio e protezione del soffietto parapolvere e del tampone di fine corsa.

The piston rod chrome-plated surface is ruined by dents, knocks and rust, with oil leaking through the oil retainer. This fault is caused by incorrectly mounting the rubber rebound bumper and the dust cover.

ALBERO ROVINATO CON LA PINZA



Ammortizzatore che presenta l'albero cromato con evidenti segni di graffiatura della superficie cromata, con conseguente perdita di olio e gas ogni qual volta la parte danneggiata entra nella guarnizione a tenuta di gomma. Danno causato dal non corretto impiego di utensili idonei al montaggio degli ammortizzatori.

A shock absorber with clear signs of scratching on the chrome plated surface of the piston rod, causing oil and gas leaks each time the damaged part enters the gasket. Damage caused by using incorrect tools to mount the shock absorber.

ALBERO USURATO



Ammortizzatore che presenta l'albero cromato danneggiato solo da un lato con evidente zona ovale arrugginita o quantomeno molto lucida e quindi consumata rispetto al resto della cromatura. Pistone quindi sottoposto ad un grosso carico laterale dovuto al non corretto serraggio con ruote a terra e soprattutto al non corretto camber del veicolo.

A shock absorber with the piston rod damaged on just one side, with a clear rusty or shiny oval patch and extensive wear with respect to the rest. The piston rod is subject to heavy side load, caused by incorrect mounting of the wheels on the ground and incorrect alignment.

ATTACCHI AMMORTIZZATORI

Shock absorbers end fitting - Type des fixations des amortisseurs - Befestigung der Stossdämpfer
 Esquema de anclajes - Diagrama de Montagem de Amortecedores - Bevestigingstype van de schokdemper - Monterings vejledning - Крепления амортизаторов

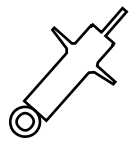
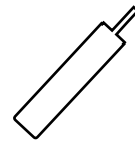
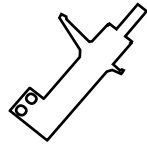

- Tipo di applicazione

- Application type
- Type de application
- Anwendung der Stossdämpfer
- Esquema de anclajes
- Esquema de Montagem
- Bevestiging van de schokdemper
- Anvendelse
- Вид применения

- Sospensione MacPherson

- Complete MacPherson strut
- Jambé de force type MacPherson
- MacPherson komplettes Federbein
- Columna de suspensión
- Coluna de Suspensão MacPherson
- Complete MacPherson veerpool
- Komplet fjerderben
- Подвеска Макферсона

- Cartuccia di ricambio MacPherson



- MacPherson insert
- Cartouche type Mac Pherson
- MacPherson Federbeinsatz
- Cartucho accesorio para columna de suspensión
- Cartucho Substituição para Coluna Suspensão MacPherson
- MacPherson patroon
- Indsats
- Заменяемый вкладыш стойки Макферсона















- Ammortizzatore con piattello portamolla

- Shock absorber with spring seat
- Amortisseur à siège de ressort
- Stossdämpfer mit Federsitzsteller
- Amortiguador con asiento para muelle
- Amortecedor com Base para Mola
- Schokdemper met veerschotel
- Støddæmper med fjeder skål
- Амортизатор с площадкой для установки пружины

<p>Occhio Eying Oeil Auge Anilha Anilha Oog Øje Отверстие</p>	<p>Occhio Eying Oeil Auge Anilha Anilha Oog Øje Отверстие</p>	<p>Perno Stud Tige Stift Esparràgo Parafuso Stift Шток</p>	<p>Silentblock Barpin Barrette Brücke Pasador Sinobloco Pin Silentblock Втулка</p>	<p>Speciale Special Spécial Besondere Especial Especial Special Special Специальная</p>	<p>Occhio Eying Oeil Auge Anilha Anilha Oog Øje Отверстие</p>	<p>Speciale Special Spécial Besondere Especial Especial Special Special Специальная</p>	<p>Occhio Eying Oeil Auge Anilha Anilha Oog Øje Отверстие</p>	<p>Perno Stud Tige Stift Esparràgo Parafuso Stift Шток</p>
<p>Perno Stud Tige Stift Esparràgo Parafuso Stift Шток</p>	<p>Silentblock Barpin Barrette Brücke Pasador Sinobloco Pin Silentblock Втулка</p>	<p>Speciale Special Spécial Besondere Especial Especial Special Special Специальная</p>	<p>Silentblock Barpin Barrette Brücke Pasador Sinobloco Pin Silentblock Втулка</p>	<p>Speciale Special Spécial Besondere Especial Especial Special Special Специальная</p>	<p>Perno Stud Tige Stift Esparràgo Parafuso Stift Шток</p>	<p>Speciale Special Spécial Besondere Especial Especial Special Special Специальная</p>	<p>Occhio Eying Oeil Auge Anilha Anilha Oog Øje Отверстие</p>	<p>Silentblock Barpin Barrette Brücke Pasador Sinobloco Pin Silentblock Втулка</p>
<p>Silentblock Barpin Barrette Brücke Pasador Sinobloco Pin Silentblock Втулка</p>	<p>Silentblock Barpin Barrette Brücke Pasador Sinobloco Pin Silentblock Втулка</p>	<p>Speciale Special Spécial Besondere Especial Especial Special Special Специальная</p>	<p>Silentblock Barpin Barrette Brücke Pasador Sinobloco Pin Silentblock Втулка</p>	<p>Speciale Special Spécial Besondere Especial Especial Special Special Специальная</p>	<p>Occhio Eying Oeil Auge Anilha Anilha Oog Øje Отверстие</p>	<p>Speciale Special Spécial Besondere Especial Especial Special Special Специальная</p>	<p>Occhio Eying Oeil Auge Anilha Anilha Oog Øje Отверстие</p>	<p>Silentblock Barpin Barrette Brücke Pasador Sinobloco Pin Silentblock Втулка</p>
<p>Silentblock Barpin Barrette Brücke Pasador Sinobloco Pin Silentblock Втулка</p>	<p>Silentblock Barpin Barrette Brücke Pasador Sinobloco Pin Silentblock Втулка</p>	<p>Speciale Special Spécial Besondere Especial Especial Special Special Специальная</p>	<p>Silentblock Barpin Barrette Brücke Pasador Sinobloco Pin Silentblock Втулка</p>	<p>Speciale Special Spécial Besondere Especial Especial Special Special Специальная</p>	<p>Occhio Eying Oeil Auge Anilha Anilha Oog Øje Отверстие</p>	<p>Speciale Special Spécial Besondere Especial Especial Special Special Специальная</p>	<p>Occhio Eying Oeil Auge Anilha Anilha Oog Øje Отверстие</p>	<p>Occhio Eying Oeil Auge Anilha Anilha Oog Øje Отверстие</p>

									
	Tutti i modelli	All models	Tous modèles	Alle Modelle	Todos los modelos	Todos os modelos	Alle modellen	Alle modeller	Все модели
	Berlina 4 porte	Saloon 4 doors	Berline 4 portes	Limousine 4 Türen	Berlina 4 puertas	Berlina 4 portas	Berline 4-deurs	Sedan 4 Døre	Седан 4-х дверный
	Berlina 3-5 porte	Hatchback - Fastback	Berline 3-5 portes	Limousine 3-5 Türen	Berlina 3-5 puertas	Berlina 3-5 portas	Berline 3-5 deurs	Sedan 3-5 Døre	Седан 3-5 дверный
	Station wagon - Familiare	Estate - Station wagon	Break	Kombi - Variant	Familiar	Familiar - Station Wagon	Stationcar	Stationcar	Универсал
	Coupé	Coupé	Coupé	Coupé	Coupé	Coupé	Coupé	Coupe	Купе
	Cabriolet - Spider	Cabriolet, Convertible	Cabriolet, Convertible	Cabriolet	Descapotable	Descapotável	Cabriolet	Cabriolet	Кабриолет / Спайдер
	Fuoristrada	Off road	Tout terrain	Geländewagen	Todo terreno	Todo-o-Terreno	Terreinwagen	Offroad 4x4	Джип
	Van - Furgoncino	Van - Commercial	Utilitaire - Fourgonette	Kastenwagen	Furgoneta - Comercial	Veículo Comercial - Furgão	Bedrijfsvoertuig	Van	Фургон - Грузовик
	Pick-Up	Pick-Up	Pick-Up	Pick-Up	Pick-Up	Pick-Up	Pick-Up	Pickup	Комби
	Autobus - Minibus - Monovolume	Bus - Minibus - Multi purpose vehicle	Bus - Minibus - Monospace	Bus - Kleinbus - Multipurpose vehicle	Autobús - Minibús - Monovolumen	Autocarro - Furgoneta	Bus - Minibus - Monospace	Bus - Minibus	Автобус - Минибус - Многоцелевое транспортное средство
	Ambulanza	Ambulance	Ambulance	Krankenwagen	Ambulancia	Ambulância	Ziekenwagen	Ambulance	Скорая помощь
	Furgone - Camioncino	Van - Truck	Camion - Camionette	LKV - Klainlaster	Camión ligero - Camioneta	Camião - Camioneta	Vrachtwagen - Bestelwagen	Varevogn	Фургон - Грузовик
	Autotelaio cabinato	Châssis cabine	Chassis Cab	Chassis Kabine	Chasis con cabina	Chassis de cabina	Chassis met cabine	Cab chassis/ Føererkabine	Грузопассажирский автомобиль
	Sinistra	Left hand	Gauche	Links	Izquierda	Lado esquerdo	Links	Venstre side	Правый
	Destra	Right hand	Droite	Rechts	Derecha	Lado direito	Rechts	Højre side	Левый
	Kit di protezione	Protection Kit	Kit de protection	Protection kit	Kit de protección	Jogo de Protecção	Beschermings-kit	Monterings kit	Защитный комплект
	Porte	Doors	Portes	Türen	Puertas	Portas	Deuren	Døre	Двери
	Ammortizzatore sterzo	Steering damper	Amortisseur de direction	Lenkungsdämpfer	Amortiguador de dirección	Amortecedor de Direcção	Stuurdemper	Styrdæmper	Амортизатор рулевой рейки
	Sterzo manuale	Without Power Steering	Sans direction assistée	Ohne Servolenkung	Sin dirección asistida	Sem Direcção Assistida	Met Stuurbevrachting	Ingen servostyring	Механическая рулевая рейка
	Servosterzo	Power Steering	Direction assistée	Mit Servolenkung	Dirección asistida	Direcção Assistida	Zonder stuurbevrachting	Servostyring	Рулевая рейка с гидросилителем

									
	Cambio manuale Manual	transmission Boîte	manuelle Schaltgetriebe	Transmisión manual	Transmissão manual	Manuele versnellingsbak	Manuel gearkasse Механическая	коробка передач	
	Cambio Automatico Automatic	Automatic transmission	Boîte automatique	Automatikgetriebe	Transmisión automática	Transmissão automatica	Automatische versnellingsbak	Automat gear kasse	Автоматическая коробка передач
N.D.	Standard	Normal duty	Standard	Standard Ausführung	Normal	Normal	Standaard	Normal	Стандарт
H.D.	Rinforzato	Heavy duty	Renforcé	Verstärkte Ausführung	Reforzado	Reforçado	Versterkt	Forstærket	Усиленный
	Ruota	Wheel	Roue	Rad	Rueda	Roda	Wiel	Hjul	Колесо
Susp.	Sospensione	Suspension	Suspension	Aufhängung	Suspensión	Suspensão	Ophanging	Ophæng/ affjedring	Подвеска
	Sospensioni sportive	Sport suspension	Suspension sport	Sportfederung	Suspensión deportiva	Suspensão Desportiva	Sportvering	Sports- affjedring	Спортивная подвеска
	Sospensione per strade accidentate Original lowered	For bad road suspension	Suspension pour routes dégradées	Federung für schlechte Straßen Suspensión para	carreteras en mal estado Suspensão para	maus pisos Vering voor slecht	wegdek Affjedring til	dåring vej Усиленная	Подвеска
	Sospensione originale ribassata Original lowered	suspension Suspension	surbaisée Tieferlegung	Suspensión rebajada original	Suspensão rebaixada	Verlaagde ophanging	Forsænket affjedring	Оригинальная спортивная подвеска	
	Sospensione autolivellante	Self levelling suspension	Correcteur d'assiette	Niveau-Ausgleich-System Suspensión	autonivelante Suspensão	autonivelável Ophanging met	niveauregeling Selvregulerende	affjedring	Подвеска авторегулируемая
	Sospensione pneumatica	Air suspension	Suspension pneumatique	Lufffederung	Suspensión neumática	Suspensão pneumática	Pneumatische ophanging	Luffaffjedring	Пневматическая подвеска
	Sospensione idropneumatica	Hydropneumatic suspension	Suspension hydropneumatique	Hydropneumatische Aufhängung	Suspensión hidroneumática	Suspensão hidropneumática	Hydropneumatische ophanging	Hydraulisk affjedring	Гидропневматическая подвеска
	Sospensione regolabile elettronica	Electronically adjustable suspension	Suspension pilotée	Elektronisch einstellbare Federung	Suspensión ajustable electrónicamente	Suspensão regulável electronicamente	Elektronisch gestuurde ophanging	Elektronisk styret affjedring	Электронно-регулируемая подвеска
	Balestra	Leaf spring	Ressort à lames	Blattfeder	Muelle de láminas	Mola de lâminas	Bladveer	Bladffjeder	Рессора
	Molla elicoidale	Coil spring	Ressort hélicoïdale	Schraubfeder	Muelle helicoidal	Mola helicoidal	Spiraalveer	Spiralfjeder	Спиральная пружина
	Ruote singole	Single wheel	Roues simples	Einzelbereifung	Ruedas simples	Rodas simples	Enkel wiel	Enkeltjful	Одиночные колеса
	Ruote gemelle	Twin wheels	Roues jumelées	Doppelbereifung	Ruedas dobles	Rodas duplas	Dubbele wielen	Tvillingehjul	Двойные колеса
	Asse rigido	Rigid axle	Essieu rigide	Feste Achse	Eje rígido	Eixo rígido	Vaste as	Stiv aksel	Жесткая ось
	Bracci indipendenti	Independant suspension	Suspension indépendat	Unabhängige Aufhängung	Suspensión independiente	Suspensão independente	Onafhankelijke wiellophanging	Uafhængig affjedring	Независимые рычаги
	Interasse	Wheel base distance	Empatement	Radstand	Distancia entre ejes	Distância entre eixos	Wielbasis- afstand	Hjulafstand	Межось

									
	Interasse corto	Short wheelbase	Empattement court	Kurzer Radstand	Distancia entre ejes corta	Dist. curta entre eixos	Korte wielbasis	Kort hjulafstand	Межось короткая
	Interasse medio	Medium wheelbase	Empattement moyen	Mittlerer Radstand	Distancia entre ejes media	entre eixos Dist. média	wielbasis Middellange	hjulafstand Межось	средняя
	Interasse lungo	Long wheelbase	Empattement long	Langer Radstand	Distancia entre ejes larga	Dist. longa entre eixos	Lange wielbasis	Stor hjulafstand	Межось длинная
	Barra di torsione singola	2 torsion bars	Train à 2 barres de torsion	2 Torsionsstäbe	2 barras de torsión	2 barras estabilizadoras	2 torsiestangen	To torsionsstænger (snoede) Двухторсионный	стабилизатор
	Doppia barra di torsione	4 torsion bars	Train à 4 barres de torsion	4 Torsionsstäbe	4 barras de torsión	4 barras estabilizadoras	4 torsiestangen	Fire torsionsstænger (snoede) Четырех торсионный стабилизатор	Четырех торсионный стабилизатор
	Trazione	Front wheel drive	Traction	Vorderradantrieb	Tracción delantera	Tracção	Voorwielaan drijving	Forhjulstræk	Передний привод
	Propulsione	Rear wheel drive	Propulsion	Hinterradantrieb	Tracción trasera	Tracção traseira	Achterwielaan drijving	Baghjulstræk	Задний привод
	Asse anteriore	Front wheels	Roues Avant	Vorderachse	Tren Delantero	Dianteira	Voor	For aksel	Передняя ось
	Asse posteriore	Rear wheels	Roues Arrière	Hinterachse	Tren Trasero	Traseira	Achter	Bag aksel	Задняя ось
2WD - 4X2	2 ruote motrici	2 wheel drive	2 roues motrices	2 Radantrieb	2 ruedas motrices	Rodas Motrizes	2 aangedreven wielen	2 hjulstræk	2 ведущих колеса
4WD - 4X4	4 ruote motrici	4 wheel drive	4 roues motrices	4 Radantrieb	4 ruedas motrices	4 Rodas Motrizes	4 aangedreven wielen	4 hjulstræk	4 ведущих колеса
excl.	Escluso	Excluding	Exclus	Ausschließlich	Excluyendo	Excepto	Exclusief	Eksklusive	Исключено
incl.	Incluso	Including	Inclus	Einschließlich	Incluyendo	Inclusivé	Inclusief	Inklusive	Включено
→ Ch. 000	Fino al numero di telaio	To chassis No.	Au chassis N°	Bis zur Fahrgestellnummer	Hasta el número de bastidor	Até ao Chassi N°	Tot chassin°	Til stelnummer	До номера шасси
Ch. 000←	Dal numero di telaio	From chassis No.	Du chassis N°	Ab Fahrgestellnummer	Desde el número de bastidor	A Partir do Chassi N°	Vanaf chassin°	Fra stelnummer	От номера шасси
O.E.	Riferimento originale	Original Part Number	Référence d'origine	Original Hinweis	Referencia original	Referência original	Origineel nummer Originalt	varenummer Оригинальный	код
ABS	Sistema antiblocco freni	Antiflock Brakes System	Freins antiblocage	Antiblockier systeme	Frenos antibloqueo	ABS	Antiblokkeer remsysteem	Med ABS	Противоблокировочная система тормозов



O.S.R.A.V. Alfeo Moret SpA - Via dell'Industria, 13 - Zona Industriale - 31029 Vittorio Veneto (TV) - ITALY
tel. +39 0438 912090 r.a. - fax +39 0438 501640 - www.osrav.it - osrav@osrav.it

www.VITALSUSPENSIONS.it

